

F-Mark2

Auto sheet feeder

Software manual

F-Mark2 software manual_02E

CONTENTS

1. iMark Plus software panel layout	1
2. Graphics file design	2
3. Layers for printing	3
4. Layers for Cutting	4
5. Save file for Cutting	5
6. Crop Marks position and Cutting area	7
7. How to use the "File Open" and "First Marker" and "Open last job"	8
8. Status and error messages of iMark Plus software	9
9. How to use "Camera brightness adjustment" and "Cutting position adjustment" and "Pause" and "Test Cut"	12
10. How to use "Cut force" and "Cut without crop marks" and "Start" and "Copies"	13
11. How to use adjust the cutting position	15
12. How to calibrate the F-Mark2	17
13. How to use Compensation	23
14. How to use Dashed line	24
15. How to use Special color	26
16. How to use Half Cutting in Special Color (Magenta lines:Half Cutting, Black lines:Half Cutting)	21
17. How to use Half Cutting in Special Color (Magenta lines:Half Cutting, Black lines:Perforation Cutting)	28
18. How to use Dashed line in Special Color (Magenta lines:Perforation Cutting, Black lines:Half Cutting)	29
19. How to use Dashed line in Special Color (Magenta lines:Perforation Cutting, Black lines:Perforation Cutting)	31
20. How to use Blade creasing in Special Color	33
21. How to use Blade creasing in Special Color (Magenta lines:Blade creasing, Black lines:Half Cutting)	36
22. How to use Blade creasing in Special Color (Magenta lines:Blade creasing, Black lines:Perforation Cutting)	38
23. How to use "Uplift" and "Insertion"	40
24. How to use "Default Speed" and "Cutting direction sorting" and "Save cut setting" and "Load cut setting" in the "More Options" button	41

1. iMark Plus software window layout

- The iMark Plus software is dedicated software for operating the Cutting Plotter CE7000-40 and Auto Sheet Feeder F-Mark2.
- The software can be installed into the computer from the accessory CD of F-Mark2.
The windows driver for the Cutting Plotter CE7000 is not required to install into the computer to use CE7000-ASF (CE7000-40 + F-Mark2).

For how to install the iMark Plus software into the computer, please refer to “F-Mark2 Setup User’s Manual”.

- The different cutting mode is available by operating the parameters in the iMark Plus software.
- The iMark Plus software quickly scans two points of registration marks by CCD camera to align the cutting position.

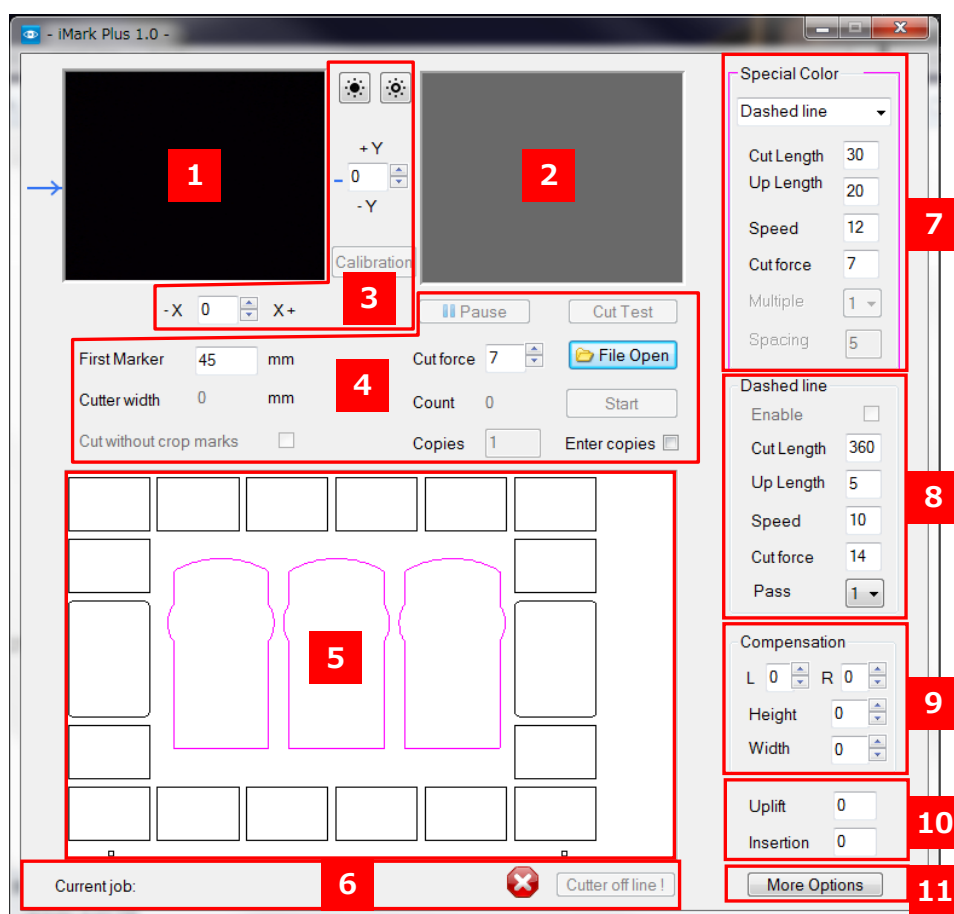

- | | |
|-------------------------------|---|
| 1 Current camera view | 7 Special color panel
(Active when the graphics files contains magenta lines) |
| 2 Last camera shot | |
| 3 Calibration commands | 8 Dashed line panel |
| 4 Common commands area | 9 Compensation |
| 5 Preview area | 10 Mechanical movement adjusting of F-Mark2 |
| 6 Status display bar | 11 More options (other functions) |

2. Graphics file design

When cutting labels with iMark Plus software, it is recommended to create separate layers for each graphics as shown below.

- **Graphics layer**

The layer with only label design drawn.



- **Cut contour**

The layer with only contour shapes of labels to be cut by F-Mark2 drawn.

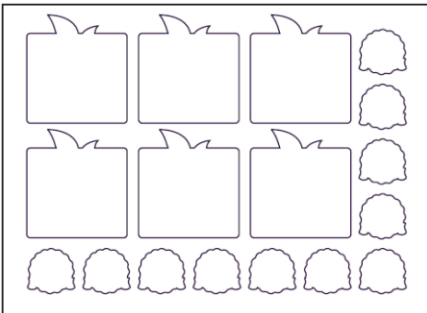

- **Crop mark layer**

The layer with only crop marks drawn.

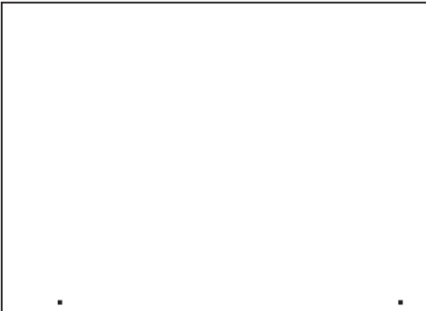

- **File for labels print.**

When printing labels with printer, enable the **Graphics layer** and the **Crop marks layer** and save the file and print it.

- **File for contour shapes of labels to be cutting.**

When cutting the contour shapes of labels with F-Mark2, enable **Cut contour layer** and **Crop marks layers** and save the file with different name from the file for printing.

- **When editing PDF format file.**

If edit a file saved in PDF format with Illustrator or Corel Draw, the outer frame may automatically generated as the border of the page. This outer frame is unnecessary for label printing and label cutting and may cause of problem of iMark Plus software, please delete it.

3. Layers for Printing

- When printing labels with printer, enable the **Graphics layer** and the **Crop marks layer** and save the file and print it.
- **Disable the Cut contour layer** to prevent printing the contour shape lines on the labels.

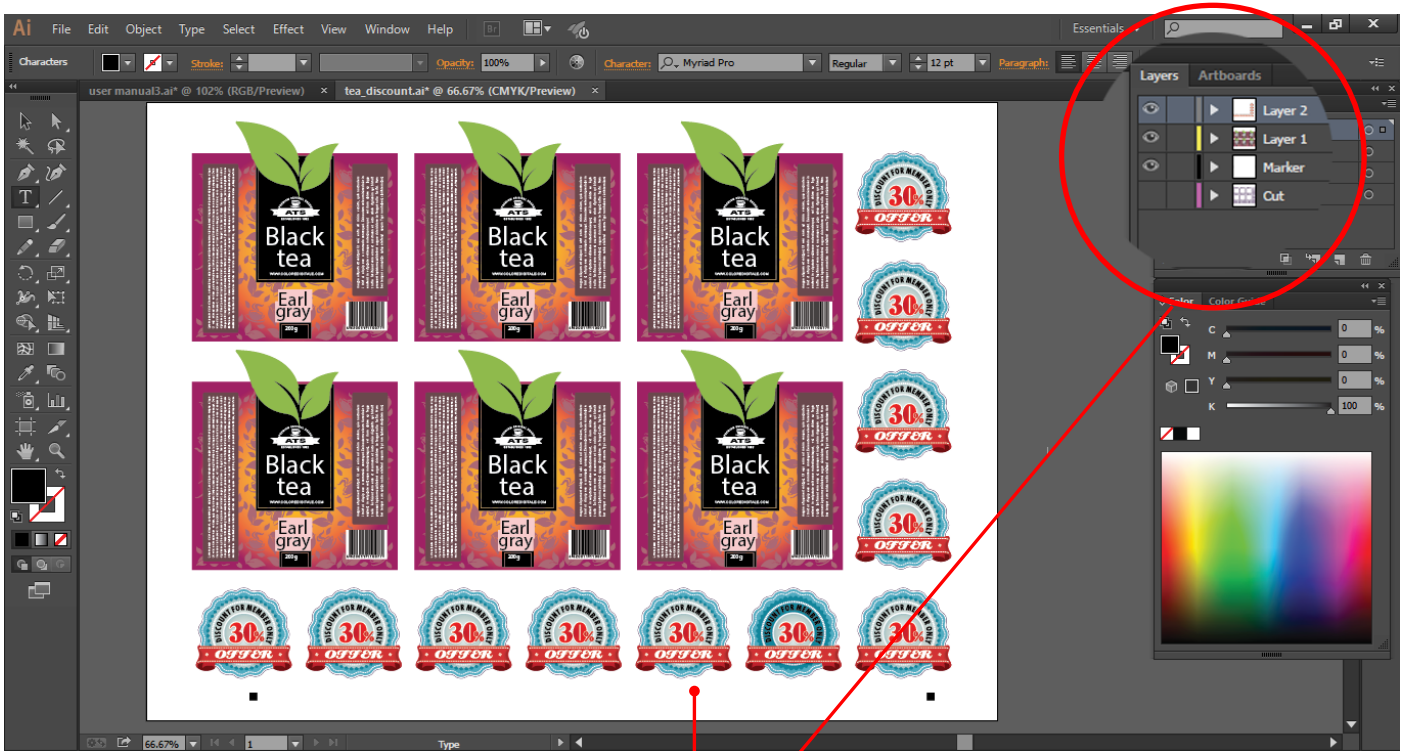

For the file for printing labels, enable only the Graphics layer and the Crop marks layer.

4. Layers for Cutting

- **File for contour shapes of labels to be cutting.**

When cutting the contour shapes of labels with F-Mark2, enable **Cut contour layer** and **Crop marks layers** and save the file with different name from the file for printing.

- **Disable the Graphics layer.**

- **If using the “guidelines” function, hide the guidelines or delete it before saving the file.**

NOTICE:

- **Use the continuous line to draw the contour shapes of labels to be cutting, if use dashed line to draw the contour shapes of labels, iMark Plus software does not work properly.**

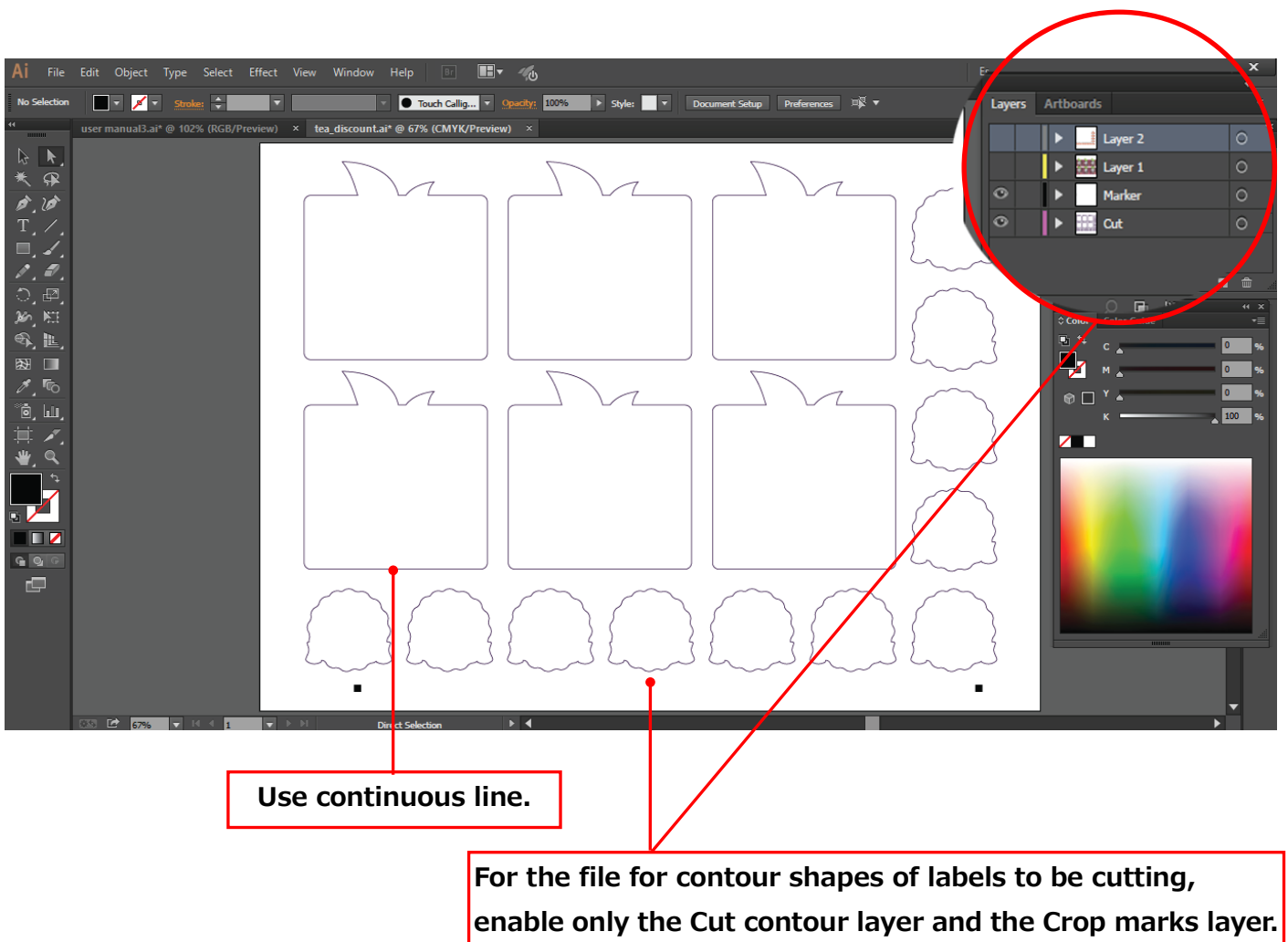

5. Save file for Cutting

- When saving the cut contour shape graphics of media size **A3, SRA3, Extended A3**, to the file, save the cut contour shape graphics in **“Horizontal (Landscape)”** view.

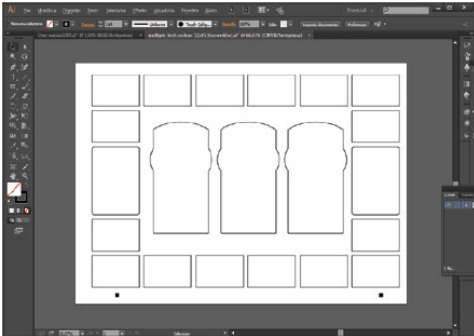

- When saving the cut contour shape graphics of media size **A4**, save the cut contour shape graphics in **“Vertical (Portrait)”** view.

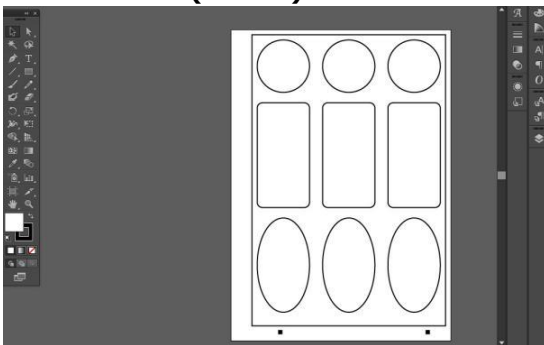

- iMark Plus software is not necessary to use specific line widths or specific colors when creating cutting lines.
- Draw the cutting lines as a continuous line.
- Make sure to set the Crop marks at the bottom of the graphics.
- iMark Plus software can be use all versions of Illustrator and Corel Draw.
- iMark Plus software the magenta lines will be treated specially.

NOTICE

When loading the cut contour graphics file drawn with the correct orientation into the iMark Plus software, the crop marks are always will be displayed on the bottom of preview window. If the crop marks are displayed vertically, iMark Plus software can not detect the crop marks, So correct the orientation of the cut contour graphics file.

The crop marks must be displayed on the bottom on the preview window.

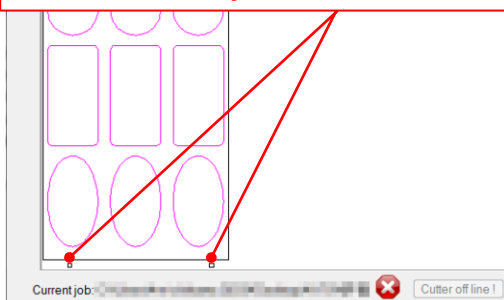

If crop marks displayed vertically, iMark Plus software can not detected crop marks

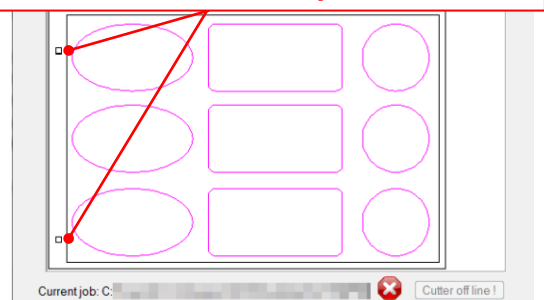

Notice when saving Illustrator file.

- When saving the cut contour shape graphics file which drawn by Illustrator, enable the cut contour layer and the Crop marks layer and save with **Illustrator 8 format**.

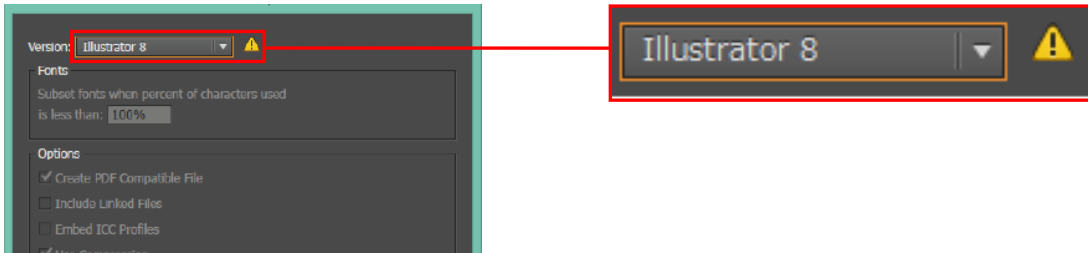

When loading the cut contour shape graphics file which has not been saved in Illustrator 8 format into the iMark Plus software, the message of “Graphics file not saved correctly” will be displayed and file can not be loaded into the iMark Plus software.

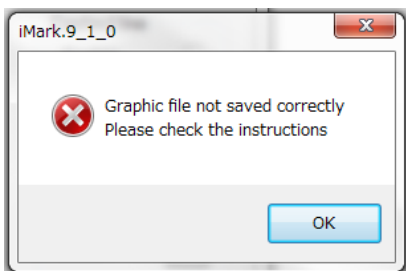

Notice when saving Corel Draw file.

- When saving the cut contour shape graphics file which drawn by Corel Draw, exporting it to **EPS format**. When exporting, enable the check box of “**Selection only**” and selecting the contour shape of labels and crop marks and save them

Notice when naming the cut contour shape graphics file.

- If use 2 byte characters in the file name of cut contour shape graphics file, iMark Plus software may not operate properly, use alphabets and numbers for file name.
- When naming the cut contour shape graphics file, naming the file with different name from the file for printing as follows.

E.g.

Name of printing graphics file: Label.ai

Name of cutting graphics file: Label_Contour.ai

6. Crop Marks position and Cutting area

Minimum distance from the front edge to cutting line
Half cutting :20mm (Recommended value:30mm)
Dashed line :25mm (Recommended value:35mm)

Minimum distance from the top edge to cutting line
5mm (Recommended value:15mm)

Minimum distance from the rear end to cutting line
5mm (Recommended value:15mm)

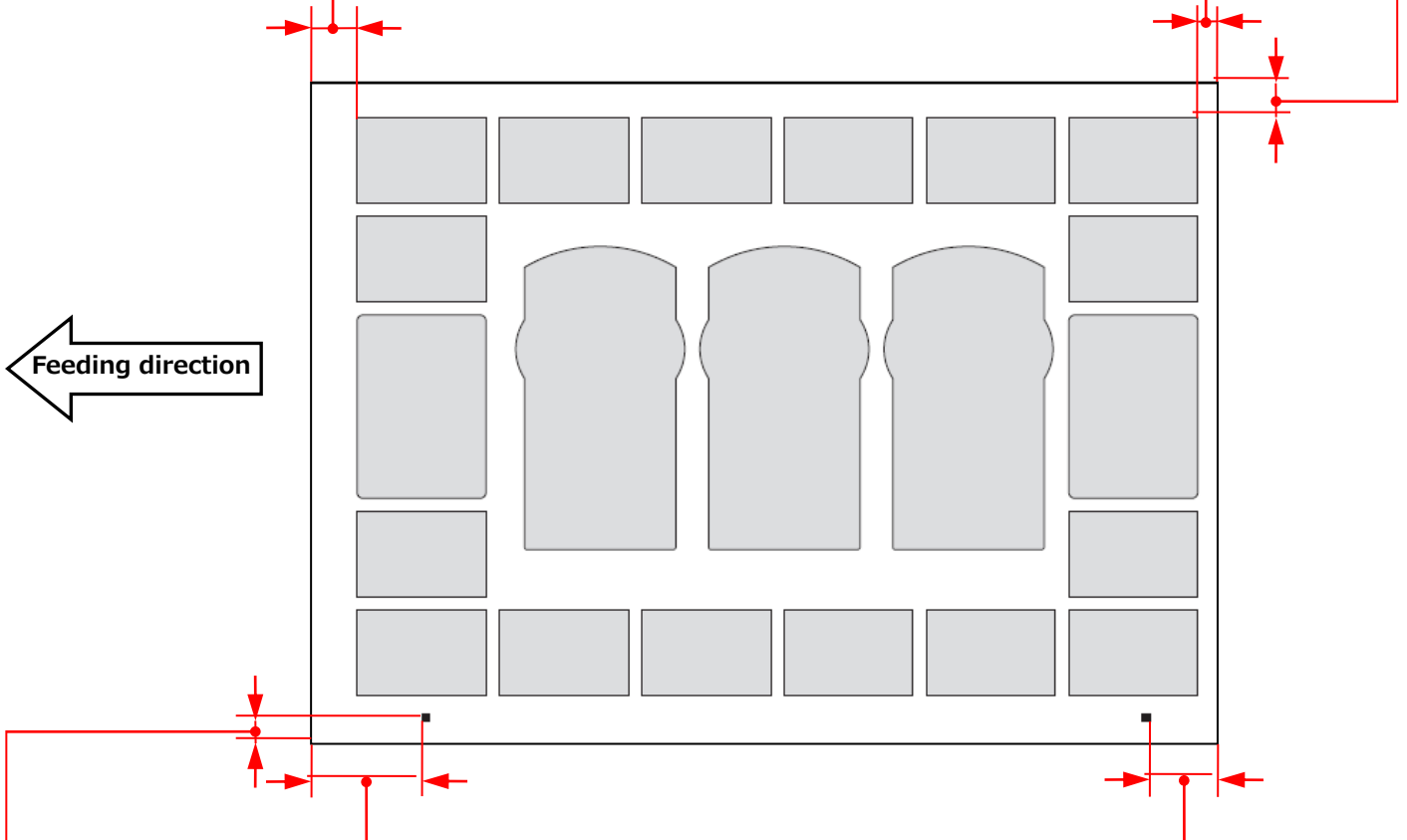

Minimum distance from the front edge to the first crop mark:**40mm**
Crop marks are 4mm square

Minimum distance from the rear end to the second crop mark:**20mm**

Minimum distance from the bottom end to the crop mark:**6mm**

Spacing between printed graphics and crop marks

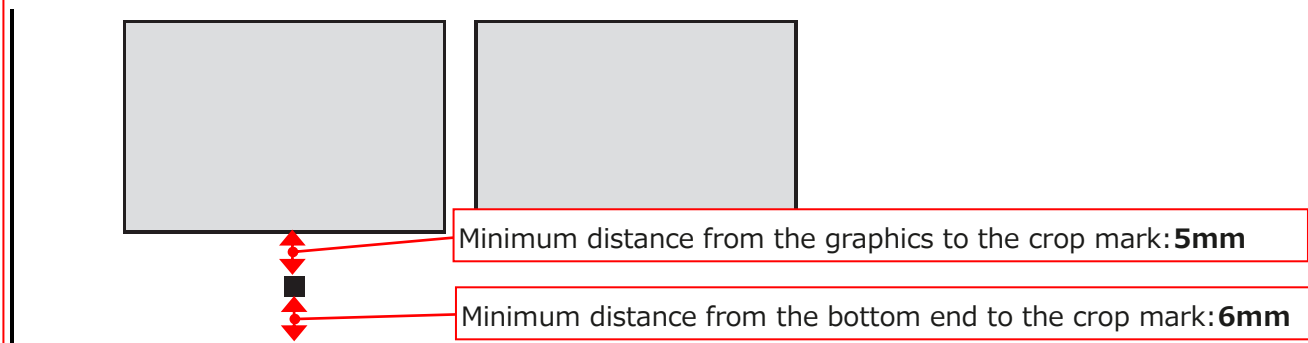

7. How to use the “File Open” and “Fist Marker” and “Open last job”

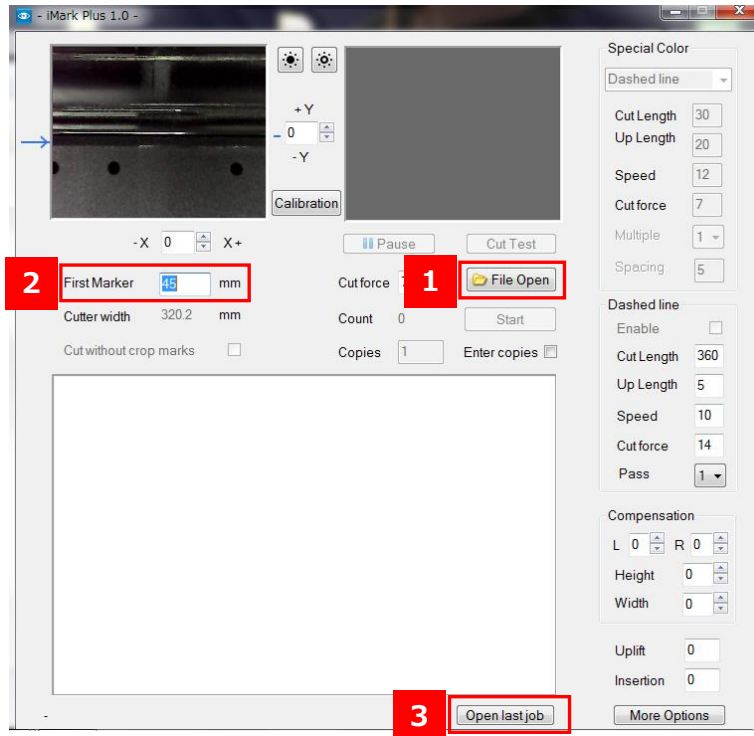

1 File Open

“File Open” button is load the cutting contour shape graphics file into the iMark Plus software. When loading the cut contour shape graphics file which has not been saved in Illustrator 8 format into the iMark Plus software, the message of “Graphics file not saved correctly” will be displayed and file can not be loaded into the iMark Plus software.

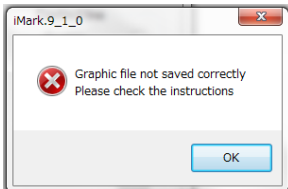

2 First Marker

For the “First Marker” input the distance from the front edge of media to the “Fist crop mark”. The error of this value is about 5 mm. If the inputted value for the “Fist Marker” is extremely different or the crop marks is not in the center of the camera, the message “Marker not found” will be displayed.

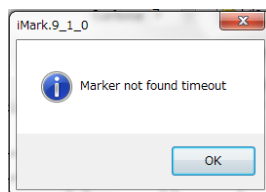
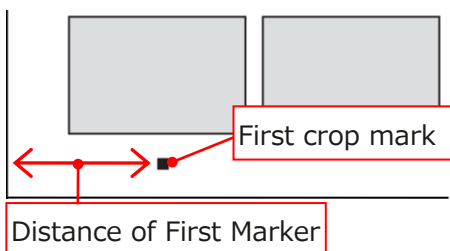

3 Open last job

When click the “Open last job” button, the cut contour shape graphics file that used last time is loaded into the iMark Plus software.

8. Status and Error messages of iMark Plus software

The current status of F-Mark2 will be displayed at the bottom of iMark Plus software window.

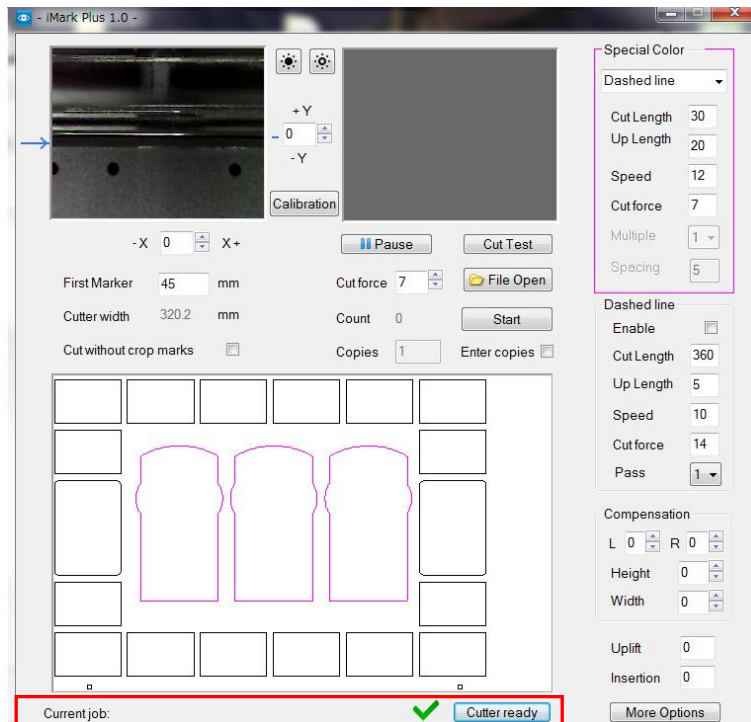

- **Current job**

When loading the cut contour shape graphics file into the iMark Plus software, the directory in the computer of the loaded file will be displayed in the "Current Job"

Current job: C:\cdr\glow gold N contour.ai

- **Cutter off line**

When "Cutter off line" will be displayed, the CE7000-40 is not available. Make sure the power of CE7000-40 is on, and USB cables are connected correctly.

For details, refer to F-Mark2 Setup User's manual.



- **Load Media**

When "Load Media" will be displayed, the CE7000-40 is connected but preparation of CE7000-40 is not finished. Rise the Media Set Lever of CE7000-40, then press the "2" button on the control panel of CE7000-40. For details, refer to F-Mark2 Setup User's manual.

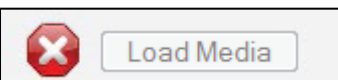

- **Cutter ready**

When "Cutter ready" is displayed, "Cut Test" and "Start" buttons are available.

Cut operation is possible.



When stating the cut with F-Mark2, if there is any problems, the error message will be displayed on the iMark Plus software window.

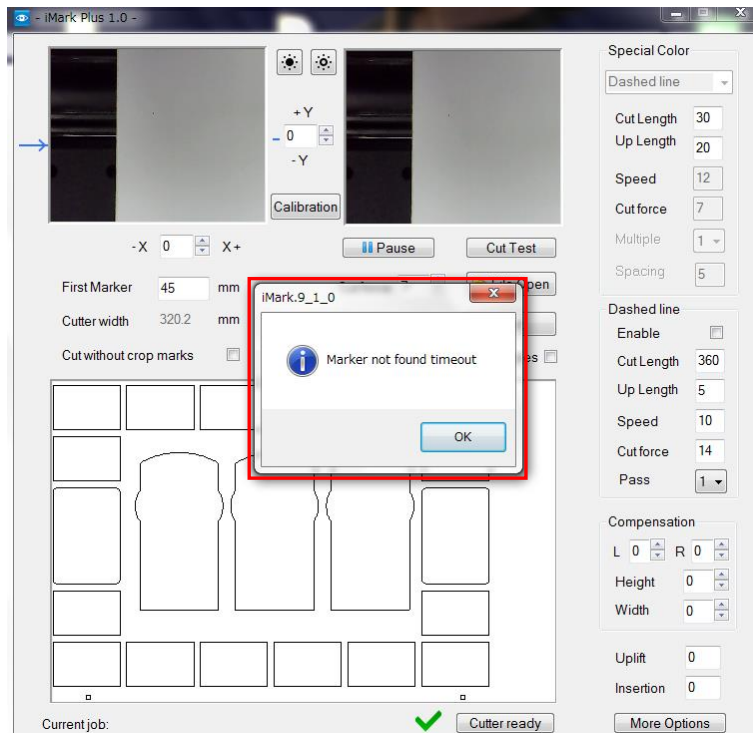

- **F-Mark feeder off or not connected**

When click "Cut Test" button or "Start" button, "F-Mark feeder off or not connected software protection not connected" will be displayed, and F-Mark2 does not work.

Make sure that the the power of F-Mark2 is on, and USB cables are connected correctly.

For the details, refer to F-Mark2 Setup User's manual.

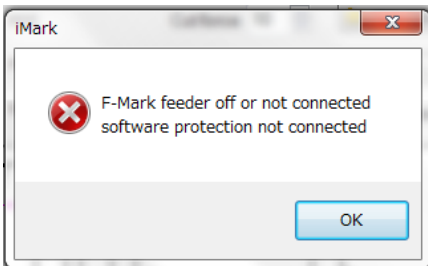

- **Could not run graph**

When "Could not run graph" will be displayed, the USB cable of the camera is may not connected to the USB Hub or multiple application softwares are running on the computer or trying to run multiple iMark Plus softwares. Make sure the the USB cable of the camera is connected correctly and close the application softwares and unnecessary iMark Plus softwares.

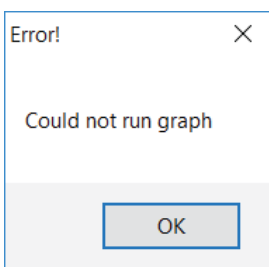

- **Graphic file not saved correctly**

When loading the cut contour shape graphics file which has not been saved in Illustrator 8 format into the iMark Plus software, the message of “Graphic file not saved correctly” will be displayed and file can not be loaded into the iMark Plus software.

Save the cut contour shape graphics file with Illustrator 8 format.

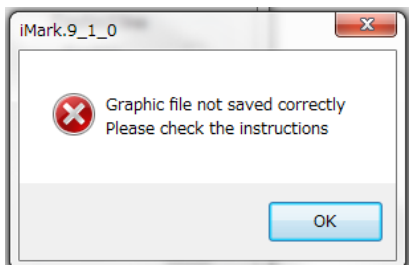

- **Marker not found timeout**

When the camera can not be read the crop marks, “Marker not found timeout” will be displayed. In this case, adjust the position of the F-Mark2 so that the crop mark can be read the camera, or make sure that the inputted value for the “First Marker” is correct, or make sure that the labels which loaded on the F-Mark2 matches the cut contour shape graphics file which loaded into iMark Plus software.

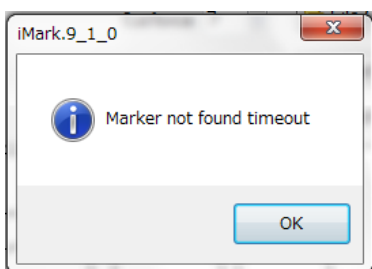

When this message is displayed, click “OK” button on the message window, the media that fed to the CE7000-40 automatically ejects to the F-Mark2.

9. How to use “Camera brightness adjustment” and “Cutting position adjustment” and “Cutter width” and “Pause” and “Test Cut”

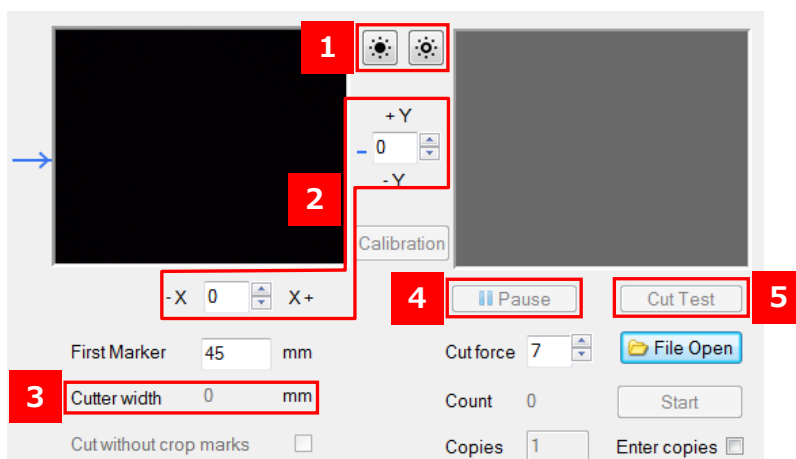

1 Camera brightness adjustment

When using media with high reflectance, it is possible to fine adjust brightness of the camera by this button.

2 Cutting position adjustment

Cutting position can be move X and Y direction by each inputted value.

Input units:0.1mm, E.g. 10=1mm

3 Cutter width

Display the width of left and right Push Rollers.

4 Pause

When click “Pause” button to stops the cutting. Clicking “Pause” button once, display is changes from “Pause” to “Resume”. When click the “Resume” button to restart the cutting.

NOTICE:

- If click the “Pause” button during the cutting, the cutting will be stopped when the current cutting is completed.

5 Test Cut

When click “Test Cut” button to start one sheets of cuts.

NOTICE:

- Make sure that the adjust the cutting position and cut force by performing the “Cut Test” before continuous cutting.
- The inputted values and changed parameter values are reflected to the cut when “Cut Test” is performed.

10. How to use "Cut force" and "Cut without crop marks" and "Start" and "Copies"

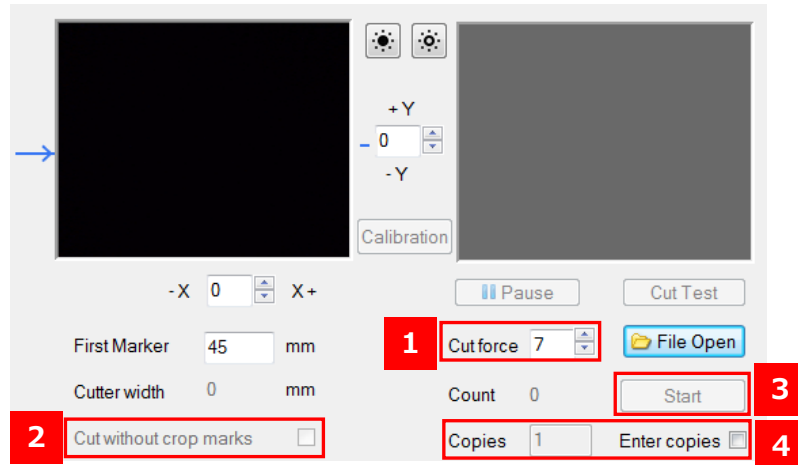

1 Cut force

Cut force of the CE7000-40 at the "Half cutting" can be change.

Adjustment range of Cut force :1 to 38

NOTICE:

- When cut force is set to higher than 14 and "Cut Test" or "Start" button clicked to start cutting, the message "High Cut force Continue?" will be displayed.

If cut force is correct, click the "Yes" button to start cutting.

If cut force is incorrect, click the "No" button to cancel the cutting, and then correct The cut force.

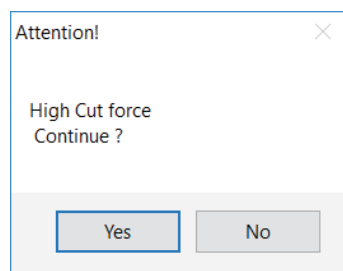

- How to adjust the cut speed at the "Half cutting"

The cut speed at the "Half cutting" can be set from the "More options" button.

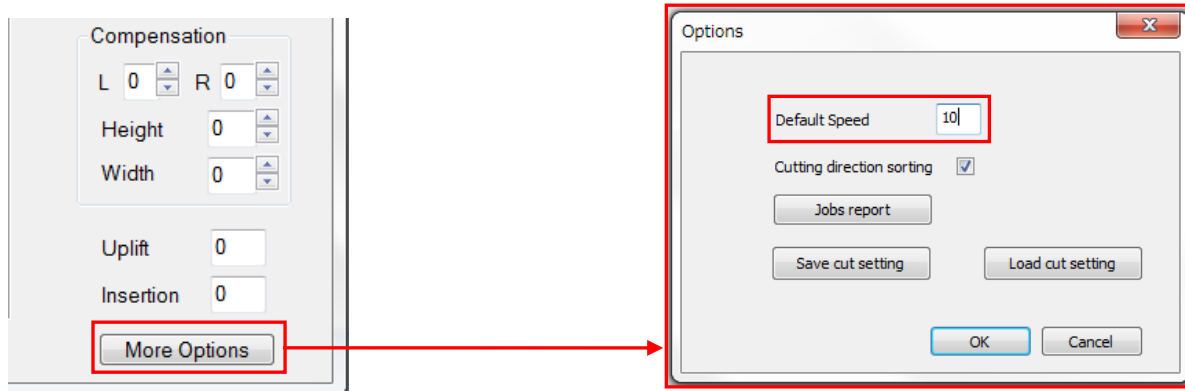

- Default Speed

It can be set cut speed at "Half cutting".

Settable values:1 to 10,15,20,25,30,35,40,45,50,55,60 [cm/sec].

2 Cut without crop marks

When check the “Cut without crop marks”, the F-Mark2 can be cut without reading the crop marks.

NOTICE:

- **Crop Marks are not read when cutting with this mode, but crop marks are required for data of cut contour shape graphics.**

3 Start

When click “Start” button launches the continuous cutting. And the number of cut sheet will be displayed on “Count”.

NOTICE:

- **The inputted values and changed parameter values are reflected to the cut when “Cut Test” is performed. Therefore, after inputting the values or changing parameter values, when performing continuous cut by click “Start” button without perform the “Cut Test”, the inputted values are not reflected to the cut.**

Check the following items before cutting the continuously by click “Start” button.

- **Make sure that the to adjust the cutting position and cut force by performing the “Cut Test”.**
- **When using labels media, perform the test cut to confirm that the length of the cutter blade is correct and that the label is correctly peeled off from the media.**
- **The cutter blade gradually wears out each time media cutting. After cutting a lot, check the cut quality before performing continuous cut.**
- **For the how to set the Cutter Plunger to the CE7000-40 and how to adjust the blade length of Cutter Plunger, refer to the User’s manual of CE7000-40.**

4 Copies

When check the “Enter copies”, it can be input the number of copies in the “Copies”.

After inputting the number of copies, performed continuous cut by “Start” button, cutting for the number of inputted in “Copies” will start.

NOTICE:

- **If click “Start” button without checking “Enter copies”, and start cutting, the cutting will continue until the media runs out.**

11. How to use adjust the cutting position

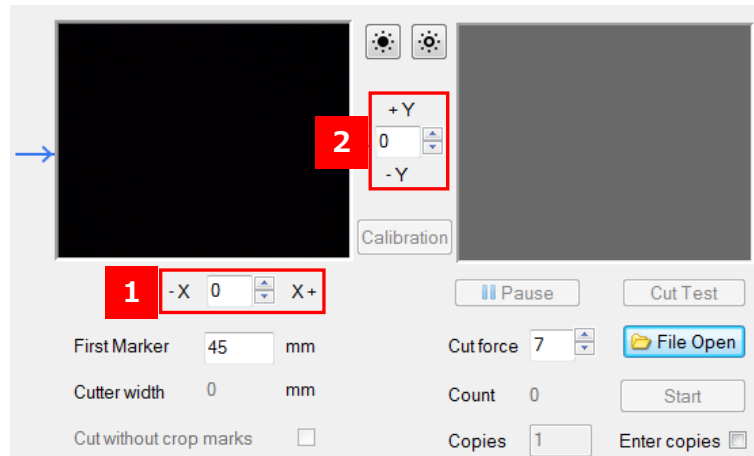

1 Adjustment of cutting position in X direction

Adjustment of cutting position in X direction can be adjusting by inputting the values in the bottom of camera preview window in the iMark Plus software.

If inputting the values in X, the cutting position can be shift to the horizontal direction of the media.

Input units:0.1mm, E.g. 1=0.1mm

2 Adjustment of cutting position in Y direction.

Adjustment of cutting position in Y direction can be adjusting by inputting the values in the right of camera preview window in the iMark Plus software.

If inputting the values in Y, the cutting position can be shift to the vertical direction of the media.

Input units:0.1mm, E.g. 1=0.1mm

- **Example of how to adjust the cutting position**

When cutting position is shifted as shown below drawing.

Adjust the cutting position according to following procedures.

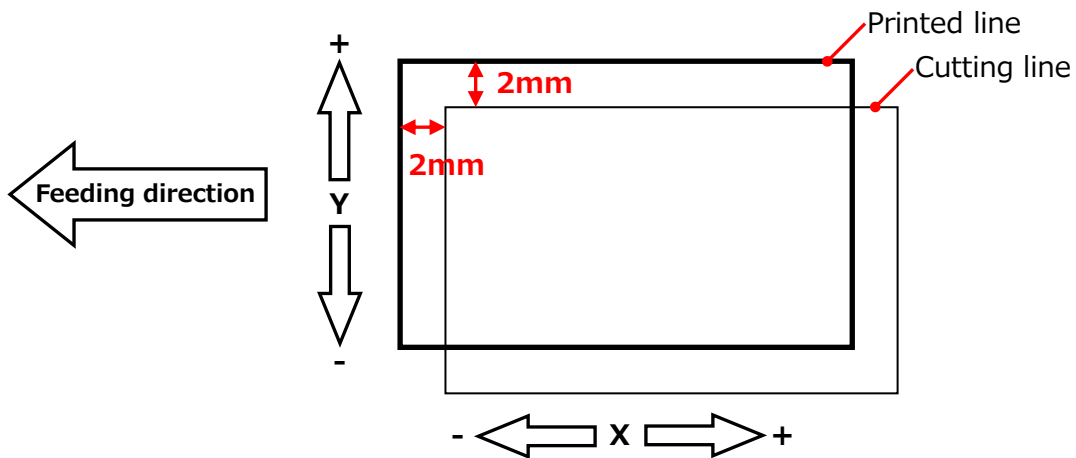

1. Input "-20" into the X, and input "20" into Y.

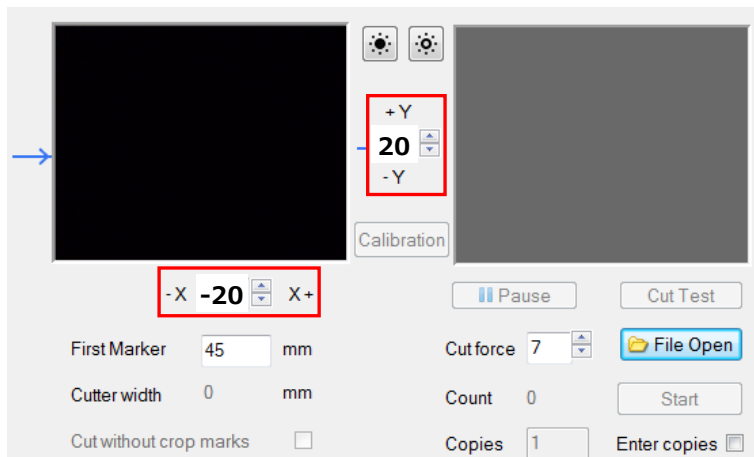

2. And then click the "Cut Test" button to perform the cut test, and confirm the cutting position.

NOTICE

- The inputted values for X and Y will not be effective for the cutting position without perform the cut by click the "Cut Test" button.
Therefore, after inputting the values for X and Y, make sure to click the "Cut Test" button to perform the cut.
- The inputted values for X and Y are reset to 0 when click the "Start" button and perform the cut, but each inputted values will be effective for shift the cutting position.
- Depending on the type of media, the adjustment values X and Y may not be 1=0.1 mm, adjust the adjustment values of X and Y depending on the cutting result.

12. How to calibrate the F-Mark2

The F-Mark2 needs to be calibration in order to read the crop mark correctly.

Please check the following items before performing the calibration of the F-Mark2.

- The iMark Plus software is installed in the operation computer.
- The F-Mark2 connected to the operation computer and CE7000-40.
- The settings of CE7000-40 has been changed to the F-Mark2.
- The angle of camera has been adjusted correctly.
- The left side Push Roller of the CE7000-40 is in the correct position.

For the details, refer to F-Mark2 Setup User's Manual.

1. Lower the Media Set Lever of the CE7000-40, and loading the "Calibration Sheet" into the CE7000-40.

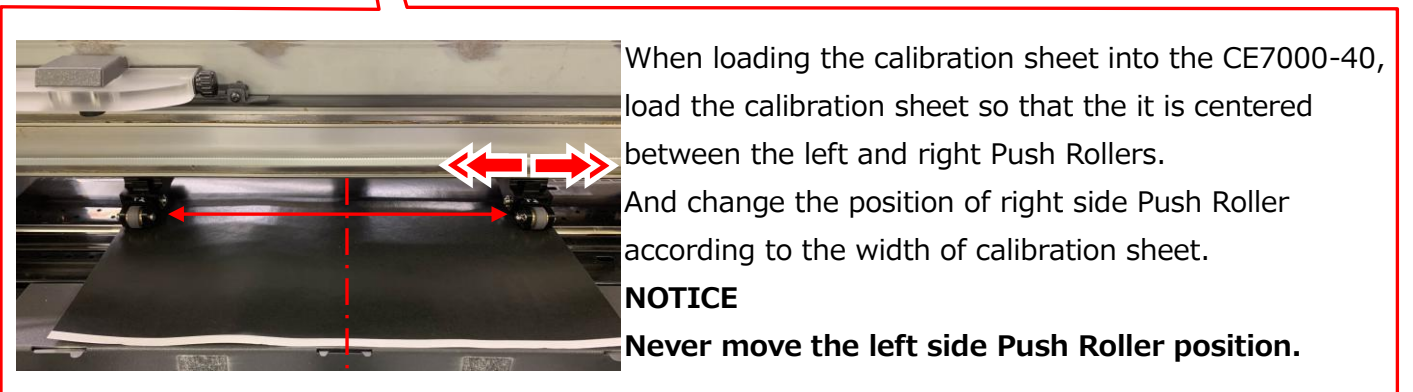

2. Rise the Media Set Lever of the CE7000-40, and then press the "2" button on the control panel of the CE7000-40.

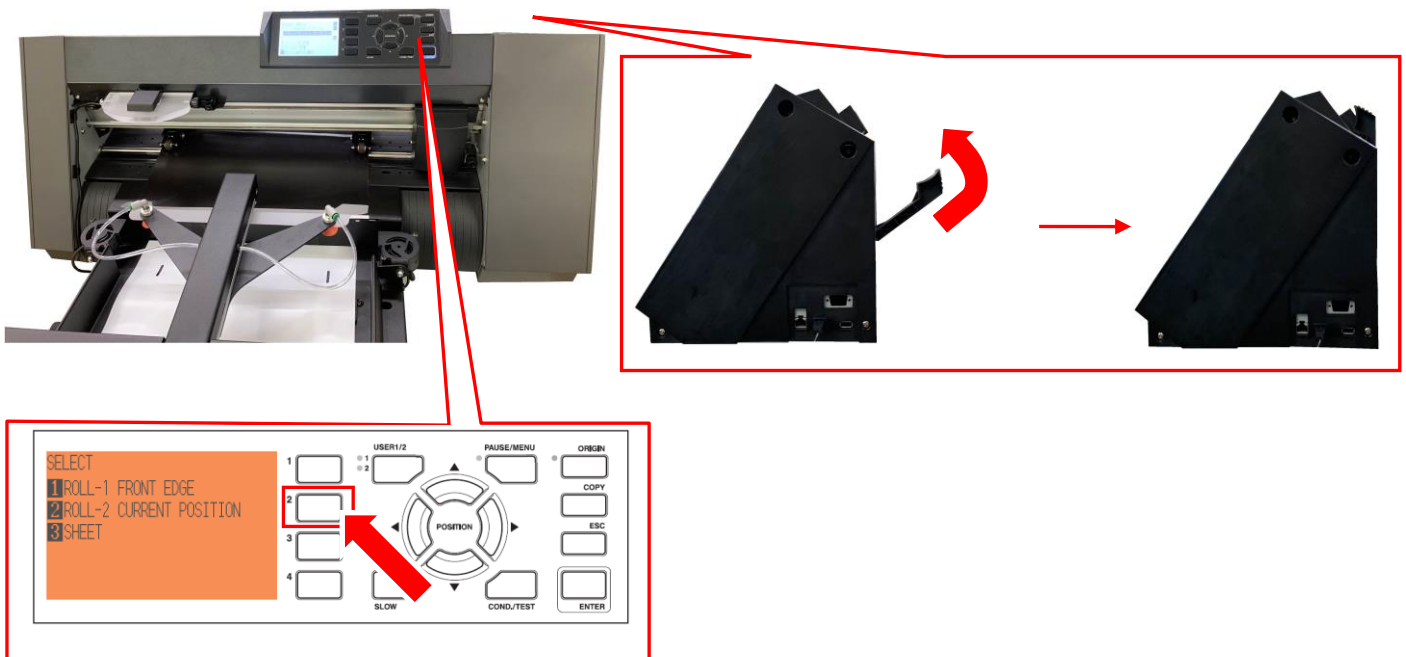

3. Set the Cutter Plunger to the back side (for Half Cutting) of the Tool holder on the CE7000-40.

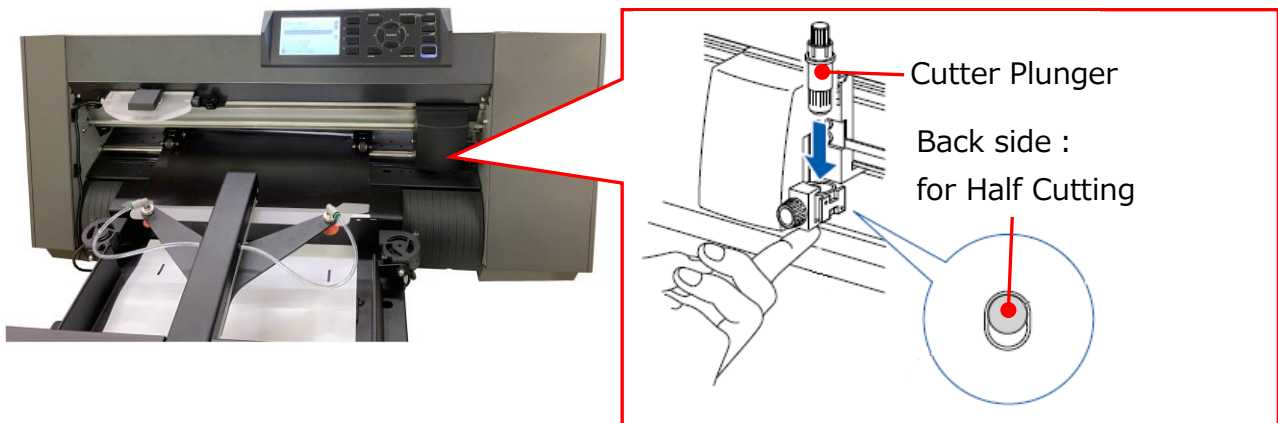

NOTICE

- For the how to set the Cutter Plunger to the Tool Holder on the CE7000-40, please refer to the User’s manual of the CE7000-40.
- For the how to adjust the blade length of Cutter Plunger, please refer to User’s manual of the CE7000-40.
- When performing the calibration of the F-Mark2, set the Cutter Plunger to the back side position (for Half Cutting) of the Tool Holder on the CE7000-40.

3. Launch the iMark Puls software, and confirm that the "Enable" in the "Dashed line" is not checked, and then click the "Calibration button"

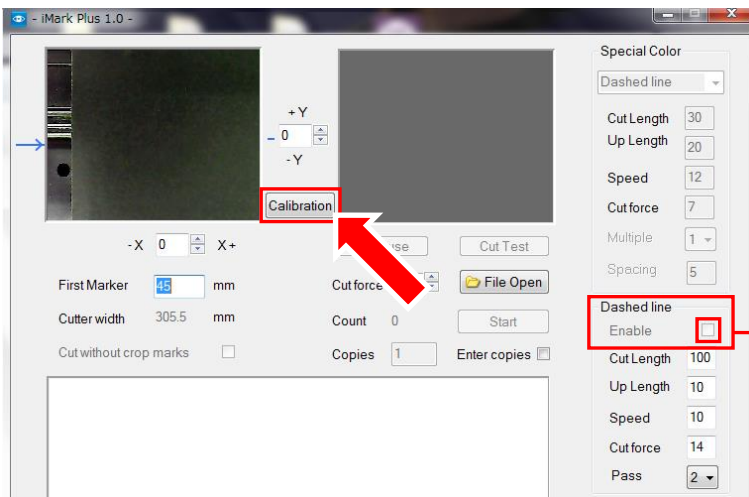

NOTICE
Calibration can not be performed correctly if "Enable" in the "Dashed line" is checked.

4. The "Calibration" window will be displayed, then click the "Cut Marker" button, and then the CE7000-40 will be cutting a small square on the Calibration Sheet.

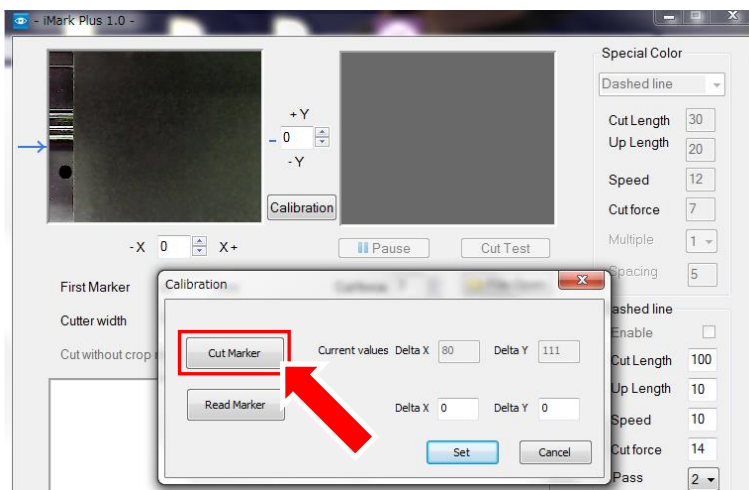

5. Peel off a small square cut by the CE7000-40 from the Calibration Sheet so that the white square can be see.

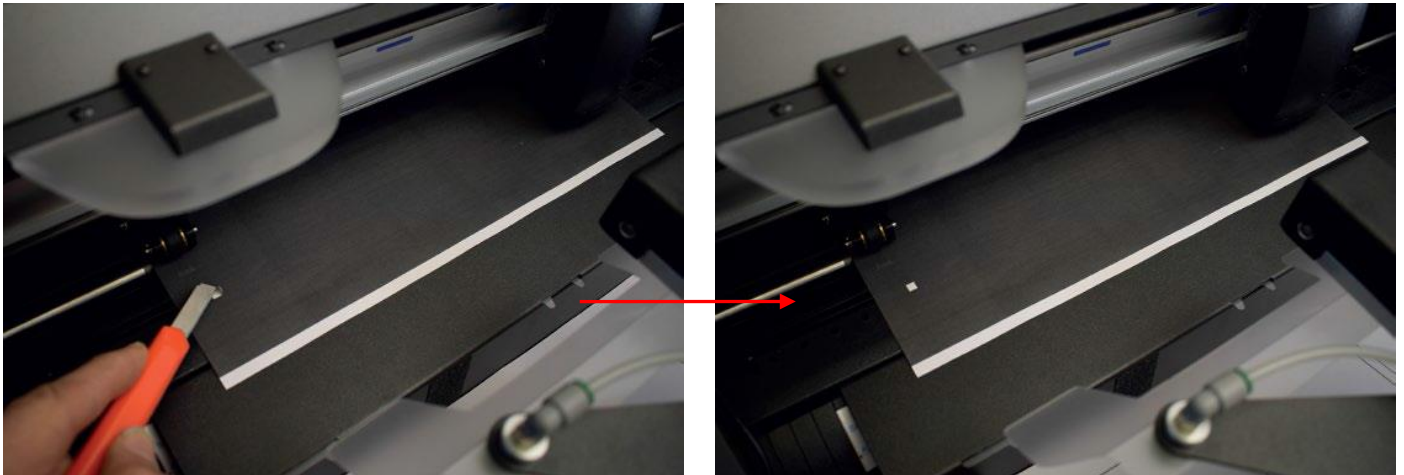

NOTICE

If the cut square can not be peeled off well from the Calibration Sheet or if the cut square cut out from the Calibration Sheet, please adjust the following items.

- Adjust "Cut force" in the iMark Plus software.

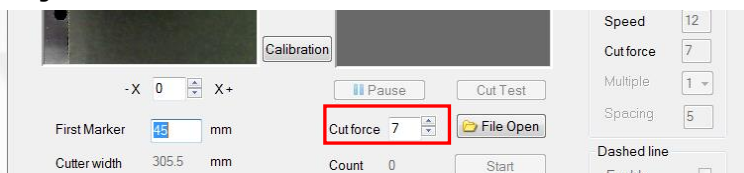

- Adjust the blade length of the Cutter Plunger.
*For the how to adjust the blade length of Cutter Plunger, please refer to User's manual of the CE7000-40.

6. Click the "Read Maker" button to read the calibration data, and then click the "Set" button to saving the calibration data.

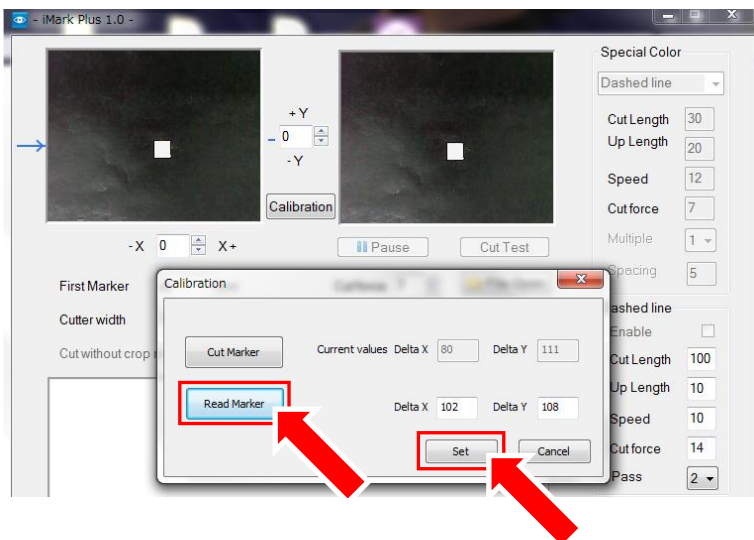

NOTICE

- **When performing "Read Maker".**
 If the "Read Marker" is performed while the calibration sheet is reflecting by the lighting in the room, the correct calibration may not be performed, in this case, please shade the camera unit so that the small square part is not reflected by the light, and then perform the "Read Maker".

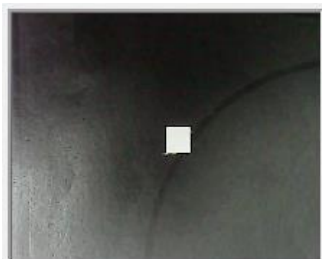

- **After performed Calibration.**
 When correct calibration is performed , the value of *90 to 120 is displayed in the "Delta X" and the value of *95 to 135 is displayed in the "Delta Y".
 (*The values are ideal values, there varies depending on the equipment.)
 If values for Delta X and Delta Y are much different than the above ideal values, the calibration was not performed correctly. Please calibration again.

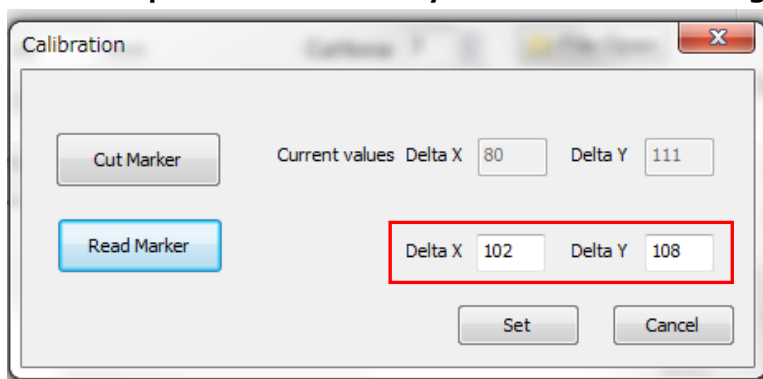

7. Click the "X" button on the upper left on the Calibration window to close it, and remove the calibration sheet from the CE7000-40 and finish the calibration.

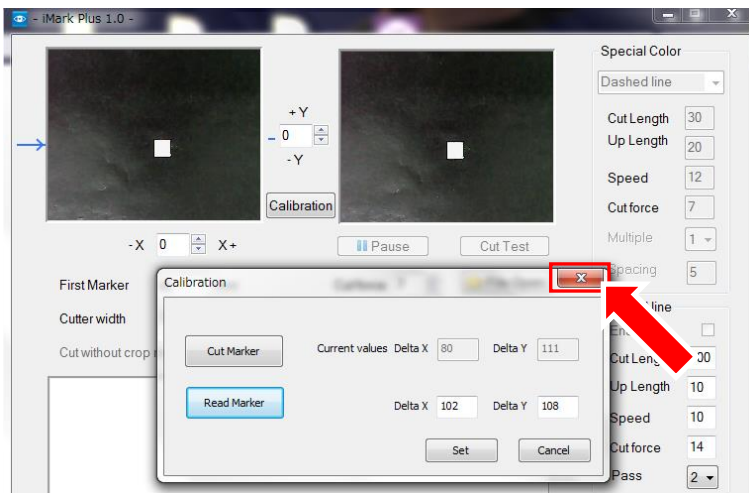

8. After calibration is finished, perform the "Test Cut" to check the calibration of the F-Mar2 is correctly.

NOTICE

- Two calibration sheets are included in the F-Mark2, if used up these, please print the "caliblack.pdf" image data which is installed to the accessory CD to the label media, and use it as a calibration sheet.
- The calibration data is saved in the operation computer.
- When change the operation computer, needs calibration with changed computer.
- When USB cable connection was disconnected, needs calibration again.
- When performing calibration under the strong lighting such as spotlight, calibration may not be preformed correctly.

13. How to use Compensation

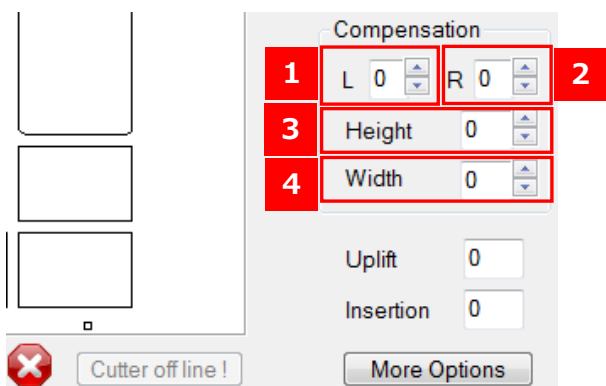

The printed images with digital printer are often distorted. The iMark Plus software uses the optical camera to detect the crop marks to correct distortions in the printed images near the crop marks and to correct the cutting position.

However, the correction of the cutting position to the distortions of the printed images where away from the crop marks are effective by the parameters of "Compensation".

1 L

The "L" parameter sets the cutting position in the upper left area of media.

Input units:0.1 mm, Settable values:-30 to 30 (-3 mm to 3 mm)

2 R

The "R" parameter sets the cutting position in the upper right area of media.

Input units:0.1 mm, Settable values:-30 to 30 (-3 mm to 3 mm)

3 Height

The "Height" parameter expands the cutting path on the height.

Input units:0.1 mm, Settable values:-100 to 100 (-10 mm to 10 mm)

4 Width

The "Width" parameter expands the cutting path on the width.

This parameter can be used when selected the "Cut without crop mark".

Input units:0.1 mm, Settable values:-100 to 100 (-10 mm to 10 mm)

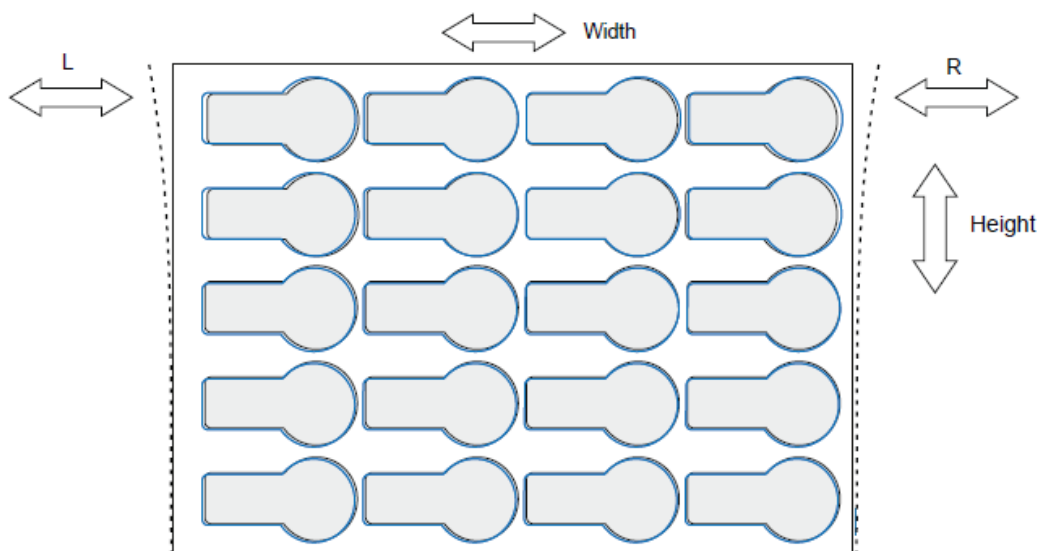

NOTICE

- After inputting the parameters, make sure to perform the cut test using the "Cut Test" button to reflect the inputted parameters values to the cutting position and confirm the Cutting position.

14. How to use Dashed line

This function can be cutting the dashed line to the cardboard. The paperweight that can be used is 120 to 350 g/m² (35to80 lbs). Make sure to perform the cut test before using any other medias. When cutting the dashed line, attach the Cutter Plunger to the front side of the tool position of the CE7000-40, then the media can be cut out because it is cut on the groove of the CE7000-40.

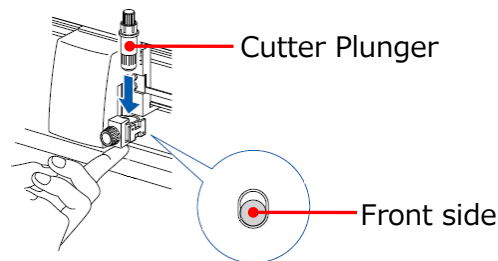

NOTICE

- For the how to set the Cutter Plunger to the CE7000-40 and how to adjust the blade length of Cutter Plunger, refer to the User's manual of the CE7000-40.

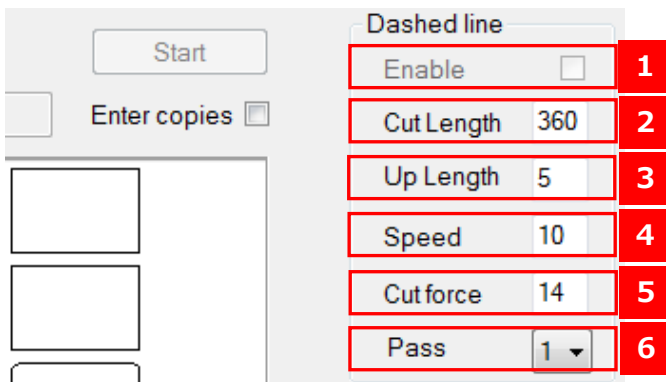

1 Enable

When perform the "Dashed line", put a check mark in "Enable".
To change the values of "Cut Length" and "Up Length", uncheck "Enable".

2 Cut Length

Length to cut with cutter.
Input units:0.1 mm, Settable values:1 to 1000 (0.1 mm to 100 mm).

3 Up Length

Length to raise the cutter and leave it without cutting.
Input units:0.1 mm, Settable values:1 to 100 (0.1 mm to 10 mm).

4 Speed

It can be set the cut speed at "Dashed line".
Settable values :1 to 10,15,20,25,30,35,40,45,50,55,60 [cm/sec].
Recommended setting values : 5 to 15 [cm/sec].

5 Cut force

It can be set the cut force at "Dashed line".

Settable values :1 to 38.

It can be reduce consumption of the cutter blade, if serring the "Cut force" less than 20 and Setting the "Pass" to 2.

6 Pass

It can be set the number of times to "Dashed line" repeatedly.

Settable values :1 to 3.

● Example of settings of Dashed line

Dashed line	
Enable	<input type="checkbox"/>
Cut Length	360
Up Length	5
Speed	10
Cutforce	14
Pass	1

When setting the Dashed line as follows,

Cut Length: 360 (36 mm)

Up Length: 5 (0.5 mm)

It will be cutting the Dashed line as shown below.

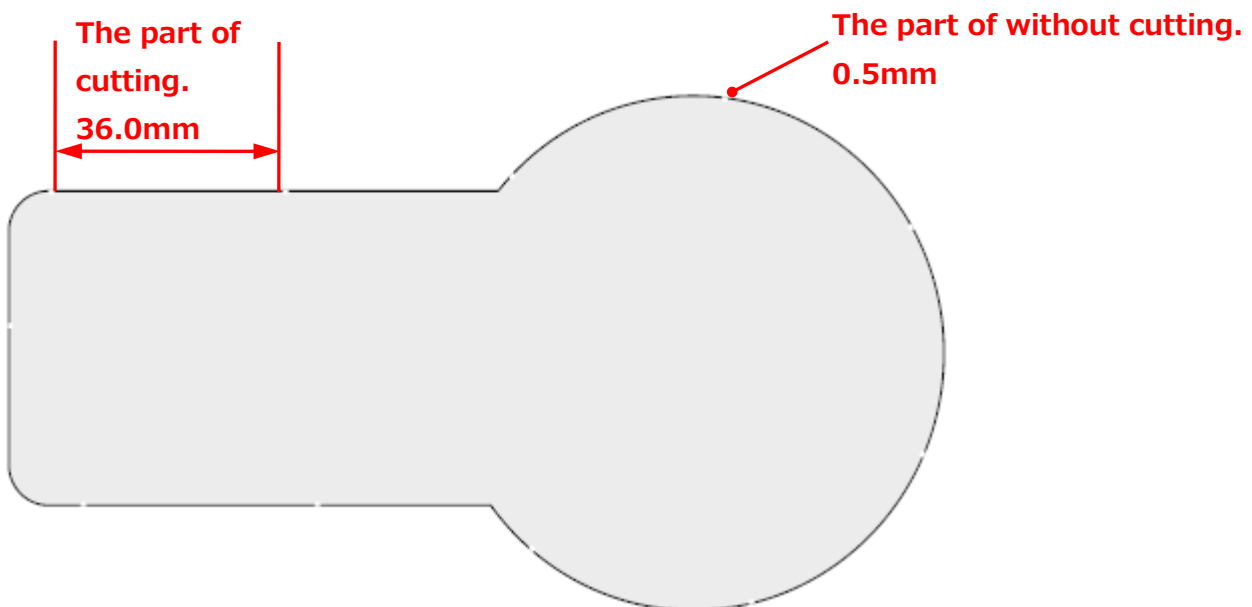

NOTICE

- When cutting to thin cardboard, leave at least 3 cm between the Push Roller and the cutting position so that the cardboard does not tear during the cutting.

15. How to use Special Color

This function treat the line drawn with 100% magenta as a cut line separately from the normal line drawn with black.

The line drawn with 100% magenta can be operated as following by “Special Color” function in the iMark Plus software.

- The line drawn with 100% magenta in not influenced by position of the image, it can be cut before the normal lines which drawn with black.
- The line with 100% magenta can be adjust the cut speed and cut force separately from the normal line drawn with black.

“Special Color” has the following three functions depending on the application.

1. Dashed line

Perforation cut to lines which drawn with 100% magenta.

2. Half Cutting

Half cuts (Kiss cuts) to lines which drawn with 100% magenta.

3. Blade creasing

Creasing cuts to lines which drawn with 100% magenta.

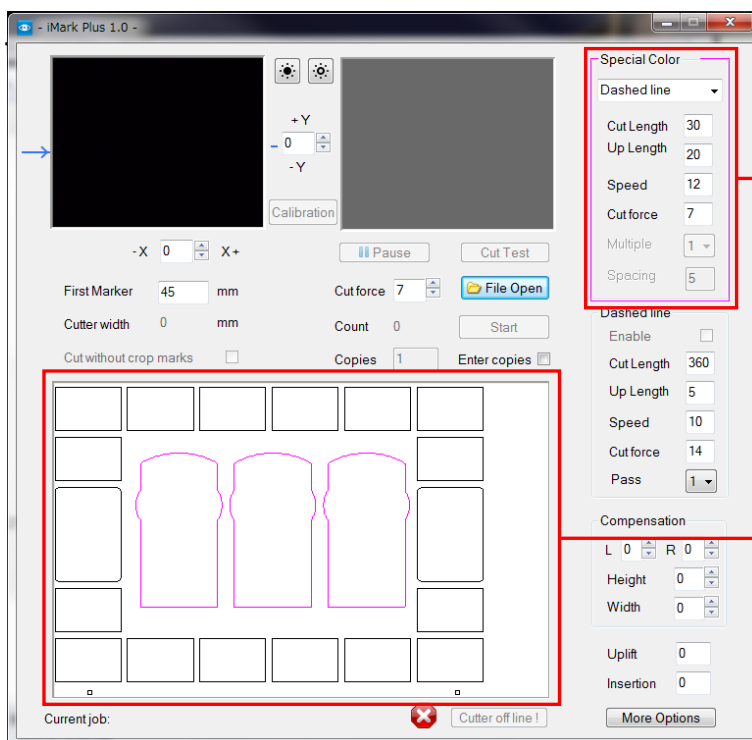

When loading the cut contour shape graphics file included the lines which drawn with 100% magenta into the iMark Plus software, the “Special Color” function is active.

The lines which drawn with 100% magenta are displayed magenta even on the preview screen of iMark Plus software.

16. How to use Half Cutting in Special Color (Magenta lines: Half Cutting, Black lines:Half Cutting)

When cutting under the following cutting modes and cutting orders.

- **1st :Magenta lines :Half Cutting.**
- **2nd:Black lines :Half Cutting.**

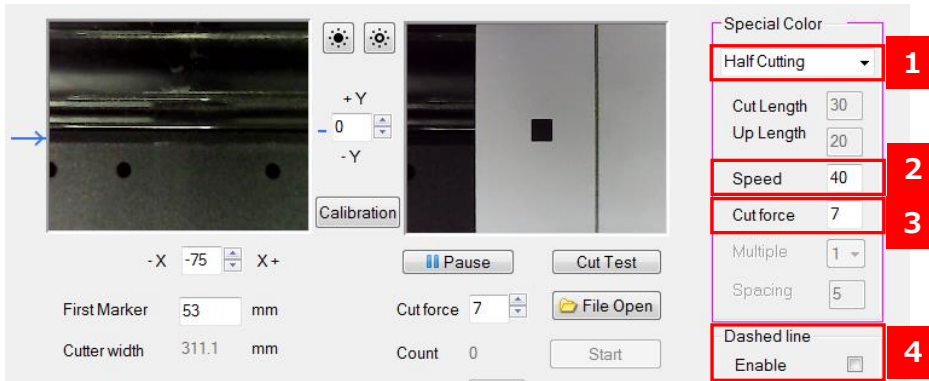

1 Half Cutting

Half cutting to magenta lines.

2 Speed

It can be set the cut speed when cutting to magenta lines.

Settable values:1 to 10,15,20,25,30,35,40,45,50,55,60 [cm/sec].

3 Cut force

It can be set the cut force when cutting to magenta lines.

Settable values:1 to 38.

4 Setting of "Dashed line"

Uncheck the "Enable" to half cutting to black lines.

- **Setting of Cutter Plunger position**

Install the Cutter Plunger to the back side.

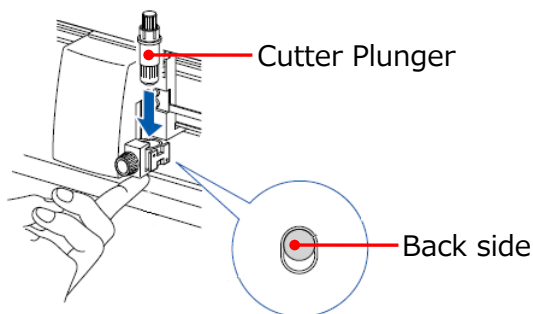

NOTICE

- **For the how to set the Cutter Plunger to the CE7000-40 and how to adjust the blade length of Cutter Plunger, refer to the User's manual of the CE7000-40.**

17. How to use Half Cutting in Special Color (Magenta lines: Half Cutting, Black lines:Perforation Cutting)

When cutting under the following cutting modes and cutting orders.

- **1st :Magenta lines :Half Cutting.**
- **2nd:Black lines :Perforation Cutting.**

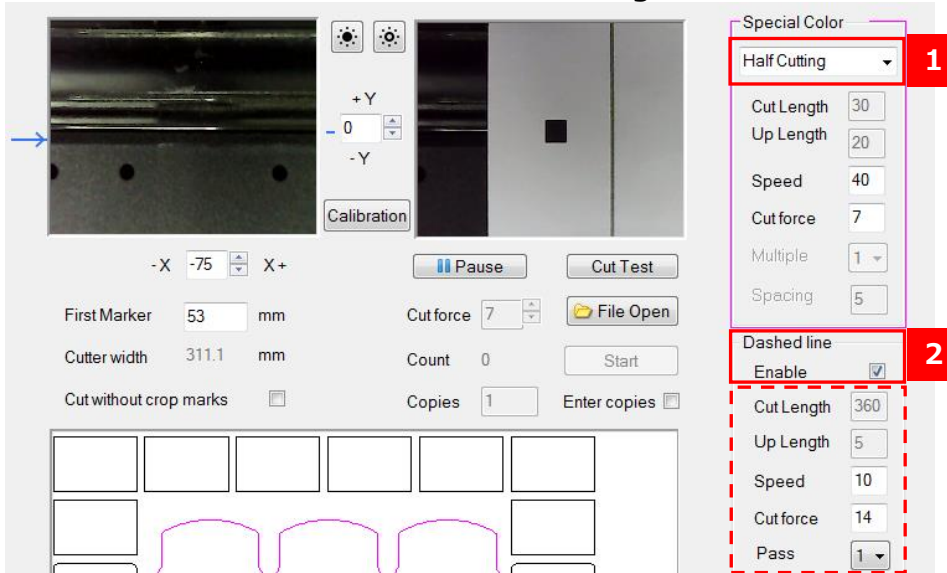

1 Setting of "Special Color"

Select the "Half Cutting" to half cutting to magenta lines.

2 Setting of "Dashed line"

Check the "Enable" to perforation cutting to black lines.

Before start cutting, set the each settings for "Dashed line".

To change the values of "Cut Length" and "Up Length", uncheck "Enable".

- **Setting of Cutter Plunger position**

Install the Cutter Plunger to the front side.

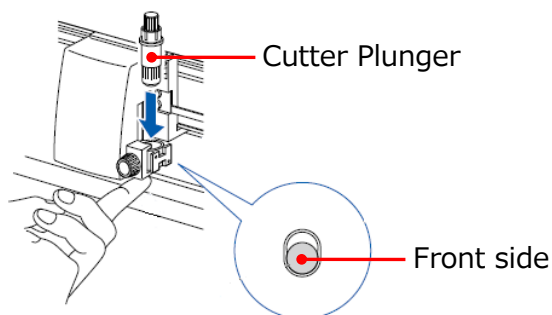

NOTICE

- **For the how to set the Cutter Plunger to the CE7000-40 and how to adjust the blade length of Cutter Plunger, refer to the User's manual of the CE7000-40.**

18. How to use Dashed line in Special Color (Magenta lines: Perforation Cutting, Black lines:Half Cutting)

When cutting under the following cutting modes and cutting orders.

- 1st :Magenta lines :Perforation Cutting.
- 2nd:Black lines :Half Cutting.

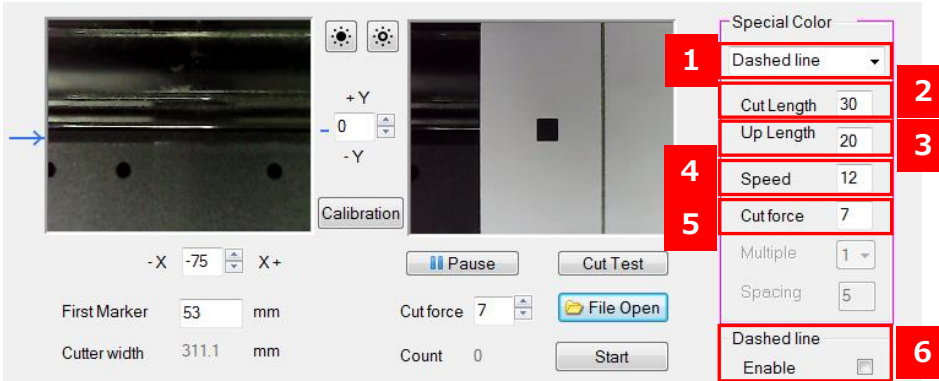

1 Dashed line

Perforation cutting to magenta lines.

2 Cut Length

Length to cut with cutter to magenta lines.

Input units:0.1 mm, Settable values:1 to 1000 (0.1 mm to 100 mm).

3 Up Length

Length to raise the cutter and leave it without cutting to magenta lines.

Input units:0.1 mm, Settable values:1 to 100 (0.1 mm to 10 mm).

4 Speed

It can be set the cut speed when cutting to magenta lines.

Settable values:1 to 10,15,20,25,30,35,40,45,50,55,60 [cm/sec].

5 Cut force

It can be set the cut force when cutting to magenta lines.

Settable values:1 to 38.

6 Setting of “Dashed line”

Uncheck the “Enable” to half cutting to black lines.

- **Setting of Cutter Plunger position**

Install the Cutter Plunger to the back side.

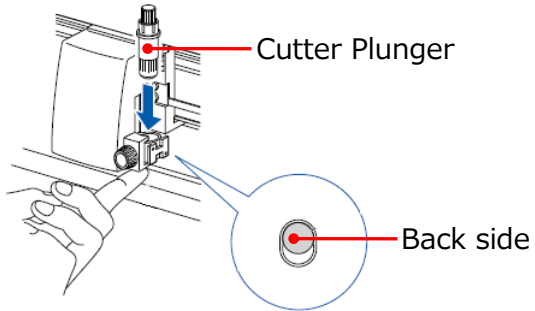

NOTICE

- For the how to set the Cutter Plunger to the CE7000-40 and how to adjust the blade length of Cutter Plunger, refer to the User’s manual of the CE7000-40.

19. How to use Dashed line in Special Color (Magenta lines: Perforation Cutting, Black lines:Perforation Cutting)

When cutting under the following cutting modes and cutting orders.

- **1st :Magenta lines :Perforation Cutting.**
- **2nd:Black lines :Perforation Cutting.**

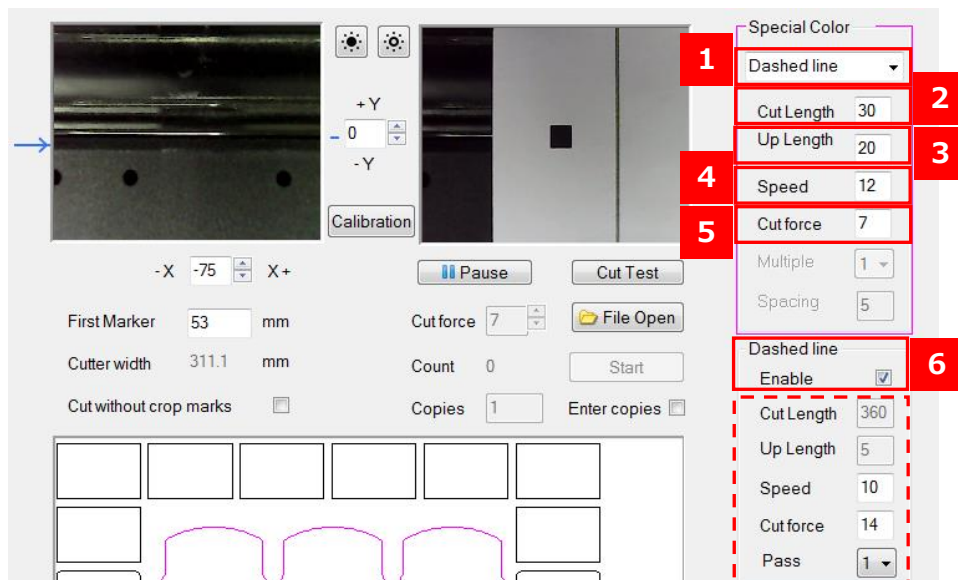

1 Setting of "Special Color"

Select the "Dashed line" to perforation cutting to magenta lines.

2 Cut Length

Length to cut with cutter to magenta lines

Input units:0.1 mm, Settable values:1 to 1000 (0.1 mm to 100 mm).

3 Up Length

Length to raise the cutter and leave it without cutting to magenta lines.

Input units:0.1 mm, Settable values:1 to 100 (0.1 mm to 10 mm).

4 Speed

It can be set the cut speed when cutting to magenta lines.

Settable values:1 to 10,15,20,25,30,35,40,45,50,55,60 [cm/sec].

5 Cut force

It can be set the cut force when cutting to magenta lines.

Settable values:1 to 38.

6 Setting of "Dashed line"

Check the "Enable" to perforation cutting to black lines.

Before start cutting, set the each settings for "Dashed line".

To change the values of "Cut Length" and "Up Length", uncheck "Enable".

- **Setting of Cutter Plunger position**

Install the Cutter Plunger to the front side.

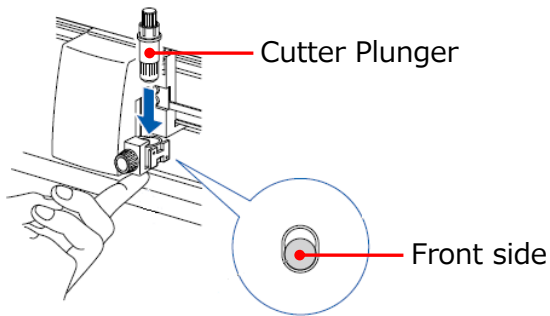

NOTICE

- For the how to set the Cutter Plunger to the CE7000-40 and how to adjust the blade length of Cutter Plunger, refer to the User's manual of the CE7000-40.

20. How to use Blade creasing in Special Color

The “Blade creasing” in the “Special Color” is makes creases by multiple cuts with cutter blade with low cut force.

The “Blade creasing” does not detects crop marks with the camera because it cuts from the back side of the printed media, but instead of that detects the corner of the media with the camera.

To detects the corner of the media, it is necessary to measure the distance from the corner of the media to the crop mark and the distance from the bottom end of the media to the crop mark with a ruler.

The cutting position accuracy of the “Blade creasing” to the printed position is about 1mm, because it depends on the printing position accuracy of the printer.

When designing the image for the “Blade creasing”, design with consideration of printing position accuracy of the printer and cutting position accuracy of the “Blade creasing”.

NOTICE:

- **Crop Marks are not detected with the camera, but crop marks are required for data of cut contour shape graphics.**
- **Crop Marks are not detected with the camera, but printing crop marks on the printed labels that to be cut is required.**

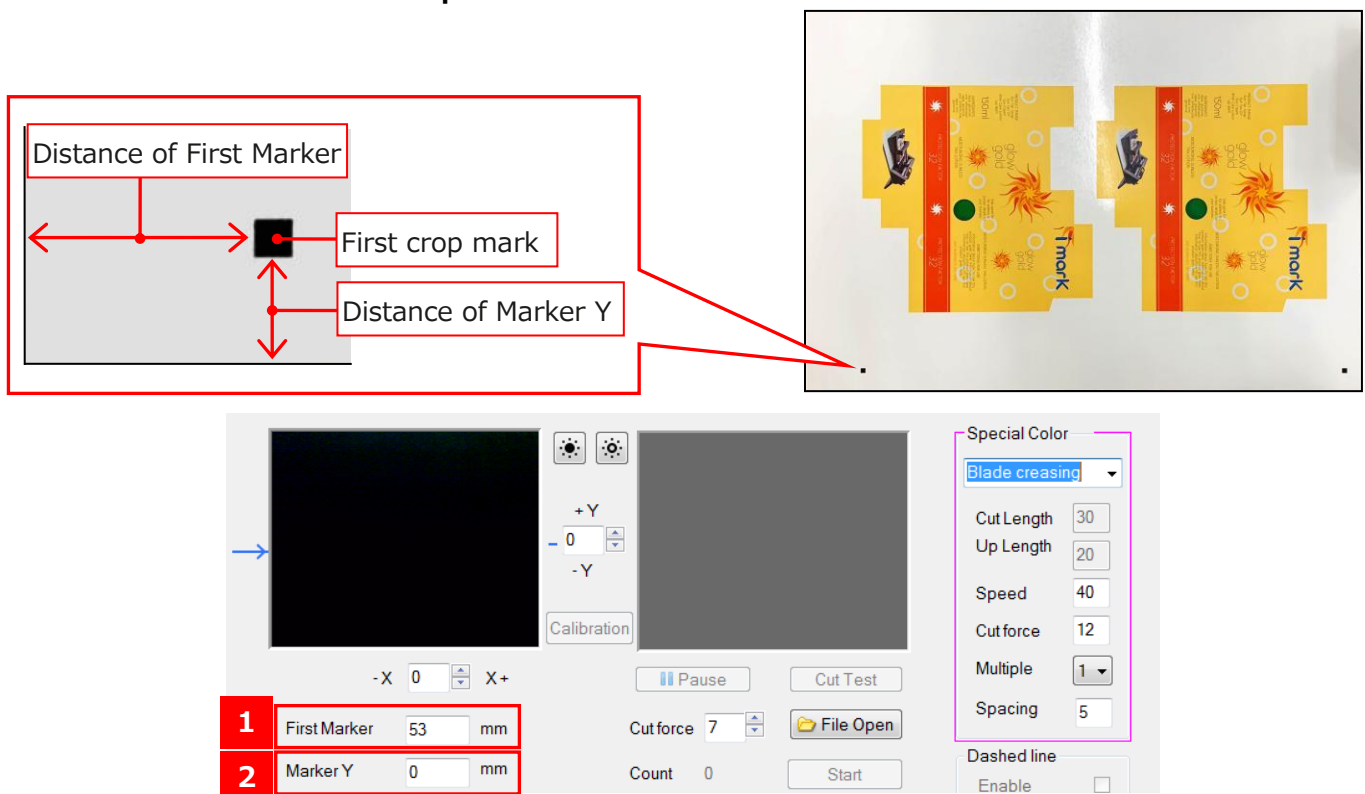

1 First Marker

Inputting the distance from the front edge of the media to the first crop mark.

2 Marker Y

Inputting the distance from the bottom end of the media to the first crop mark.

- **How to loading the media into the F-Mark at “Blade creasing” cutting**

When cutting at “Blade creasing”, loading the media into the F-Mark2 with pay attention following contents.



- Need to load the media with printed side down.
- Be careful to place the side with the crop marks on the camera side.
- Adjust the position of the F-Mark2 so that the edge of media can be displayed on the camera preview in the iMark Plus software.

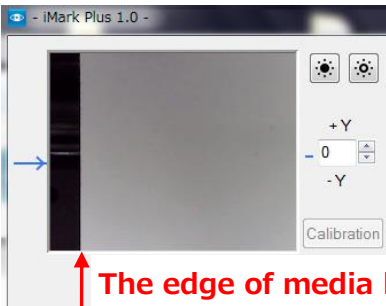

If the edge of media is not displayed on the camera preview, the error message “Edge of the sheet not found” will be displayed when reading the first crop mark with the camera.

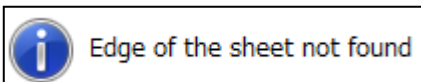
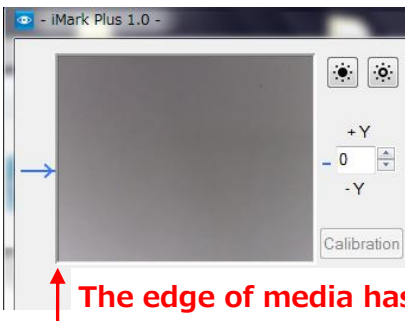

The message will be displayed, due to the edge of media can not be found with the camera.

- **Crop marks position and cutting area at “Blade creasing” cutting**

The crop marks position and cutting area at “Blade creasing” are different from normal cutting. For the details, refer to following contents.

The minimum distance of the cut path from the right border of the media is **25 mm**

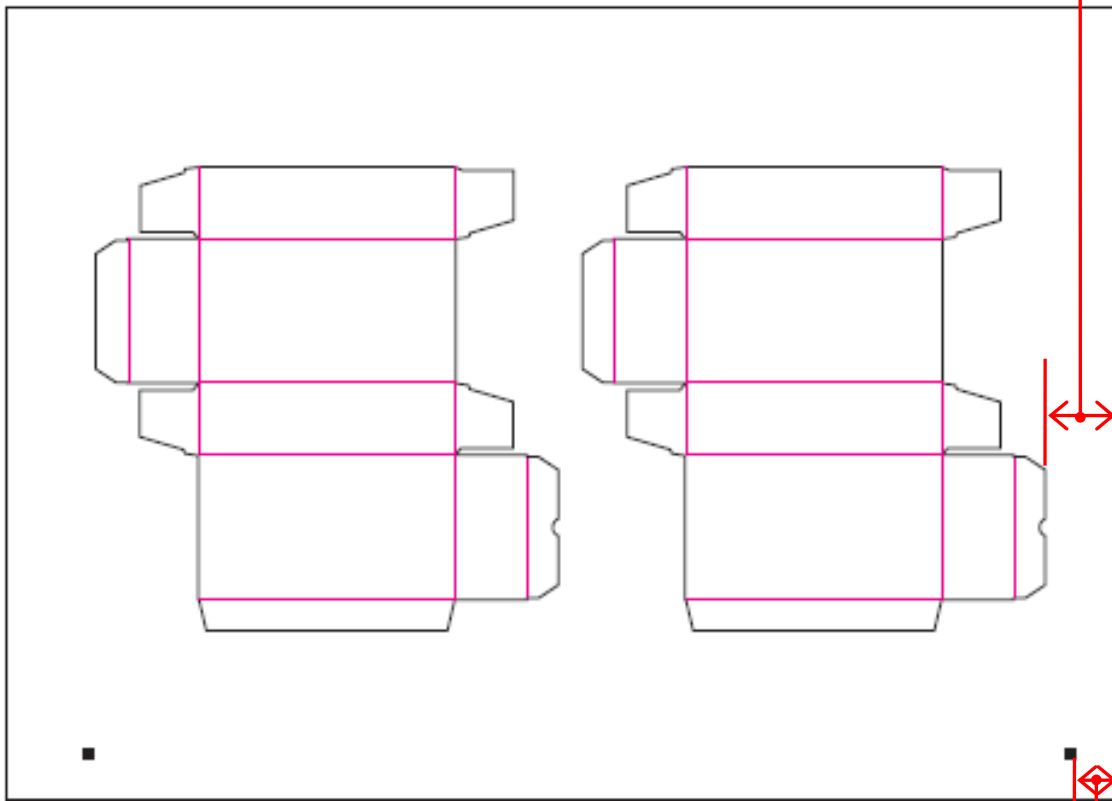

The distance of the second crop mark to the right border must be **15 mm to 10 mm**

21. How to use Blade creasing in Special Color (Magenta lines: Blade creasing, Black lines:Half Cutting)

When cutting under the following cutting modes and cutting orders.

- 1st :Magenta lines :Blade creasing.
- 2nd:Black lines :Half Cutting.

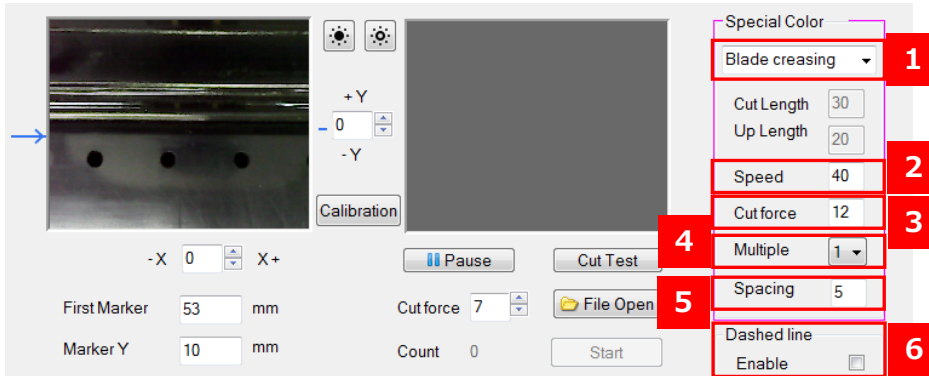

1 Blade creasing

Blade creasing to magenta lines.

2 Speed

It can be set the cut speed when cutting to magenta lines.

Settable values:1 to 10,15,20,25,30,35,40,45,50,55,60 [cm/sec].

3 Cut force

It can be set the cut force when cutting to magenta lines.

Settable values:1 to 38.

4 Multiple

It can be set the number of times to repeat the “Blade creasing” cut.

Settable values:1 to 5

5 Spacing

It can be set the spacing between the cut lines when repeating the “Blade creasing” cut.

Input units:0.1 mm, Settable values:1 to 20 (0.1 mm to 2 mm).

6 Setting of "Dashed line"

Uncheck the "Enable" to half cutting to black lines.

- **Setting of Cutter Plunger position**

Install the Cutter Plunger to the front side.

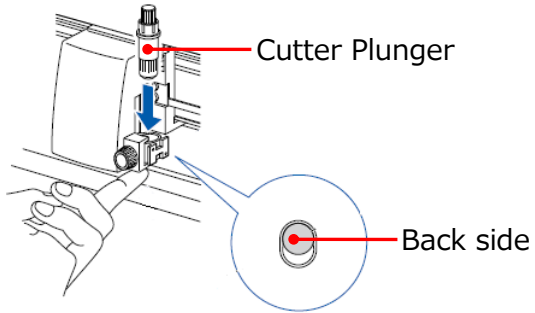

NOTICE

- For the how to set the Cutter Plunger to the CE7000-40 and how to adjust the blade length of Cutter Plunger, refer to the User's manual of the CE7000-40.

22. How to use Blade creasing in Special Color (Magenta lines: Blade creasing, Black lines:Perforation Cutting)

When cutting under the following cutting modes and cutting orders.

- 1st :Magenta lines :Blade creasing.
- 2nd:Black lines :Perforation Cutting.

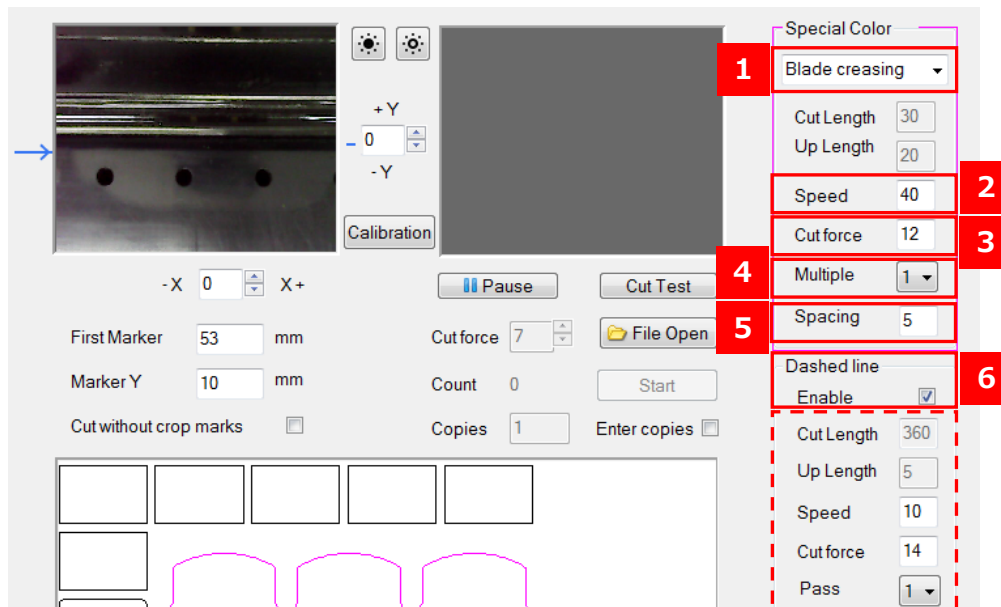

1 Blade creasing

Blade creasing to magenta lines.

2 Speed

It can be set the cut speed when cutting to magenta lines.

Settable values:1 to 10,15,20,25,30,35,40,45,50,55,60 [cm/sec].

3 Cut force

It can be set the cut force when cutting to magenta lines.

Settable values:1 to 38.

4 Multiple

It can be set the number of times to repeat the “Blade creasing” cut.

Settable values:1 to 5

5 Spacing

It can be set the spacing between the cut lines when repeating the “Blade creasing” cut.

Input units:0.1 mm, Settable values:1 to 20 (0.1 mm to 2 mm).

6 Setting of "Dashed line"

Check the "Enable" to perforation cutting to black lines.

Before start cutting, set the each settings for "Dashed line".

To change the values of "Cut Length" and "Up Length", uncheck "Enable".

- **Setting of Cutter Plunger position**

Install the Cutter Plunger to the front side.

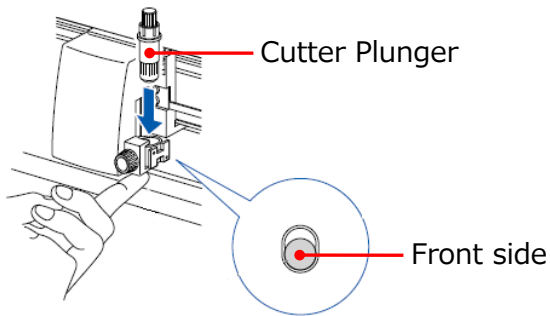

NOTICE

- For the how to set the Cutter Plunger to the CE7000-40 and how to adjust the blade length of Cutter Plunger, refer to the User's manual of the CE7000-40.

23. How to use "Uplift" and "Insertion"

On the right bottom of the iMark Plus software window, there are two settings for fine adjustment the movement of the Insertion Arm.

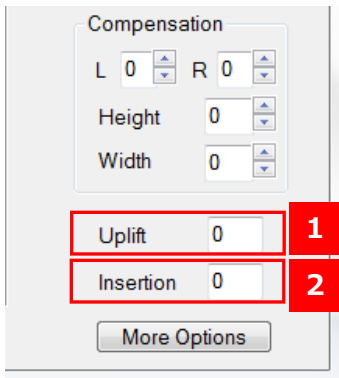

1 Uplift

It can be adjust the height of the Insertion Arm when inserting the media to the CE7000-40. If media drops by hitting the edge of "Cutting Mat" or "Groove of cut" on the CE7000-40, increase the Uplift value to that the media does not hit the edge of "Cutting Mat" or "Groove of cut" on the CE7000-40.

Input units:0.1 mm, Settable values:-100 to 100 (-10 mm to 10 mm).

2 Insertion

It can be adjust the media insertion distance when inserting the media to the CE7000-40. If the insertion value is not enough, the media will not be reach to the Push Roller of the CE7000-40, so the media can not be fed into the CE7000-40.

If the insertion value is too much, the front edge of media will be deformed or jammed by the Push Roller of the CE7000-40, so that the media can not be fed into the CE7000-40.

Input units:0.1 mm, Settable values:-100 to 155 (-10 mm to 15.5 mm).

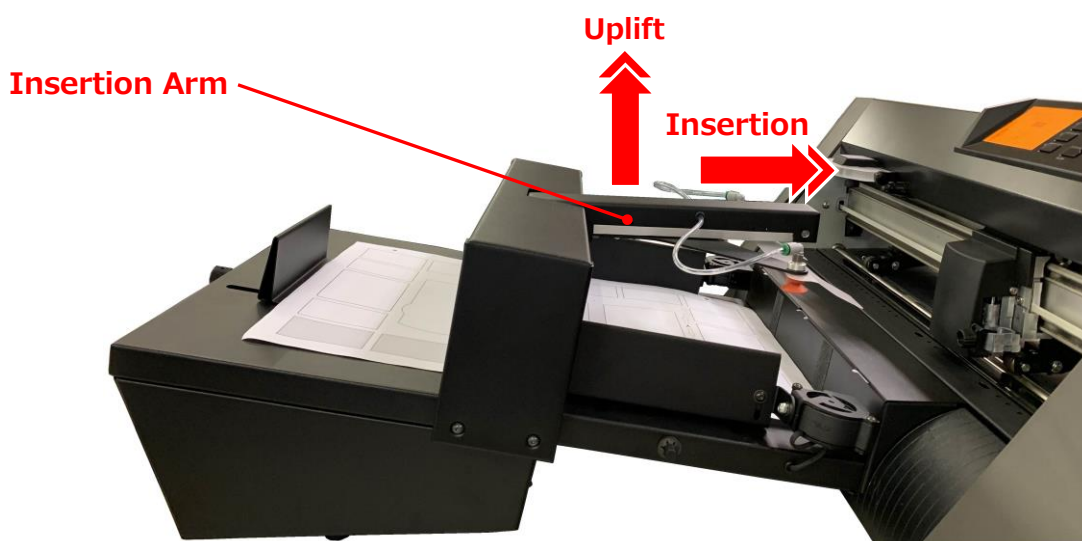

24. How to use “Default Speed” and “Cutting direction sorting” and “Job report” and “Save cut setting” and “Load cut setting” in the “More Options” button

On the right bottom of the iMark Plus software window, there is “More Option” button. In the “More Option”, following settings can be set.

1. Default Speed

It can be set cut speed when “Half Cutting” to black lines.

2. Cutting direction sorting

It can be change the order of cutting.

3. Jobs report

It can be displayed the history list of cutting jobs.

4. Save cut setting

It can be save the settings of the iMark Plus software.

5. Load cut setting

It can be load the saved settings into the iMark Plus software.

NOTICE

- “Save cut setting” function can not save the number of copies.

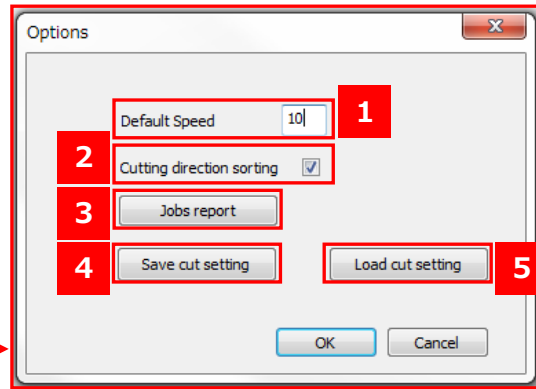
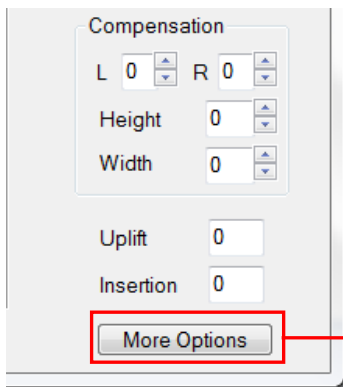

1 Default Speed

It can be set cut speed when “Half Cutting” to black lines.

Settable values: 1 to 10,15,20,25,30,35,40,45,50,55,60 [cm/sec].

2 Cutting direction sorting

It can be change the order of cutting.

- When “Cutting direction sorting” is checked, the order of cutting is automatically adjusted so that the moving distance becomes shorter as shown below figure.

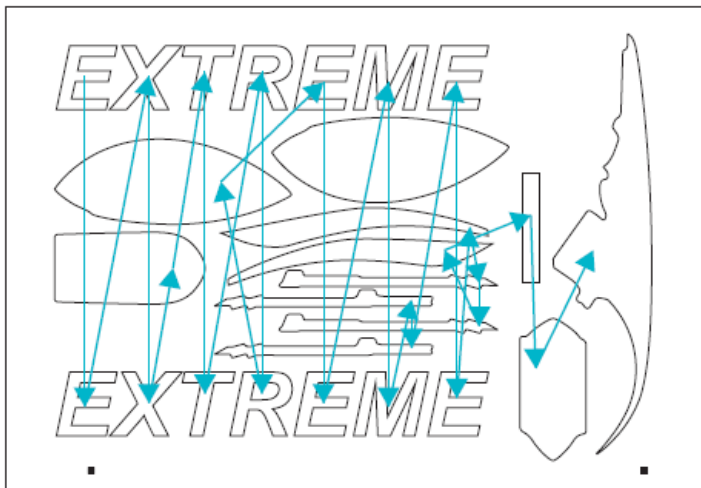

- When “Cutting direction sorting” is unchecked, the order of cutting is reversed order of drawing order of cut contour shape graphics as shown below figure.

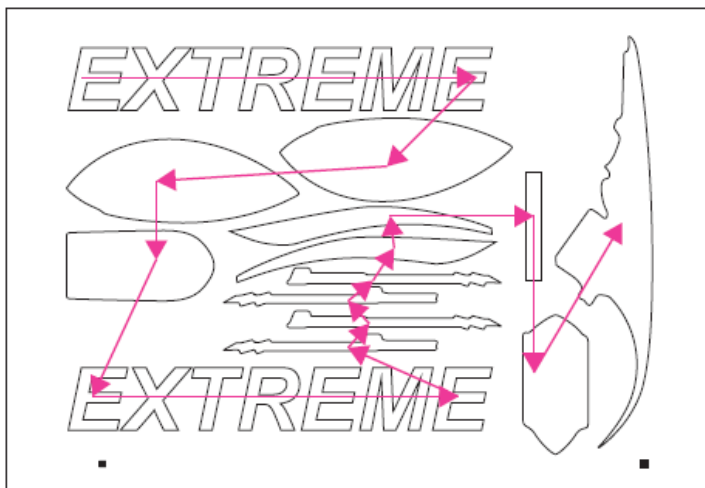

3 Jobs report

It can be displayed the history list of cutting jobs.

The jobs displayed in the history list are only jobs which executed with "Start" button,

The jobs which executed with "Cut Test" are not displayed in the history list.

In the history list the following contents are displayed.

a Jobs name

It is displayed the directory in the computer where the job file (cut contour shape graphics file) stored.

b Copies

It is displayed the number of copy for each job.

c Time

It is displayed the time spent cutting for each job.

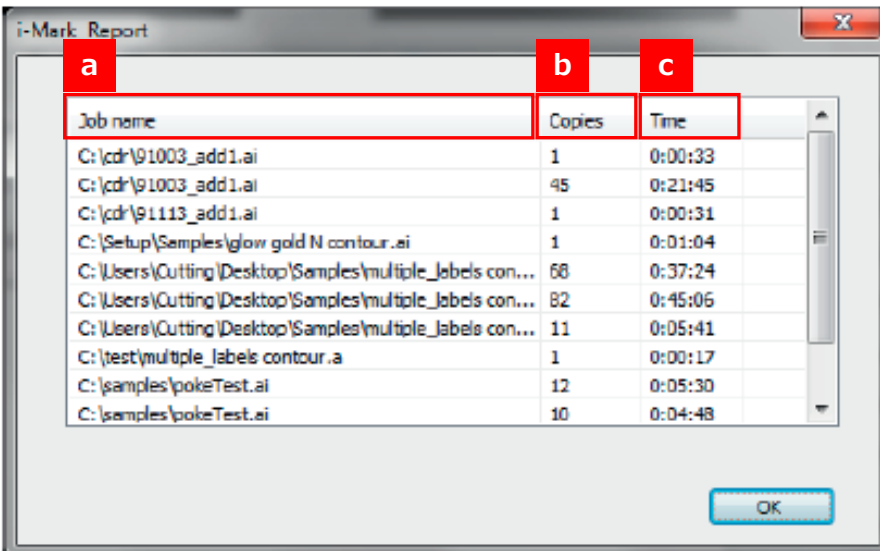

a Job name	b Copies	c Time
C:\cdr\91003_add1.ai	1	0:00:33
C:\cdr\91003_add1.ai	45	0:21:45
C:\cdr\91113_add1.ai	1	0:00:31
C:\Setup\Samples\glow gold N contour.ai	1	0:01:04
C:\Users\Cutting\Desktop\Samples\multiple_labels con...	68	0:37:24
C:\Users\Cutting\Desktop\Samples\multiple_labels con...	82	0:45:06
C:\Users\Cutting\Desktop\Samples\multiple_labels con...	11	0:05:41
C:\test\multiple_labels contour.a	1	0:00:17
C:\samples\pokeTest.ai	12	0:05:30
C:\samples\pokeTest.ai	10	0:04:48

4 Save cut setting

It can be save the settings of the iMark Plus software with following procedure.

NOTICE

- Can not save the number of copies.

1. Click the "Save cut setting" button.

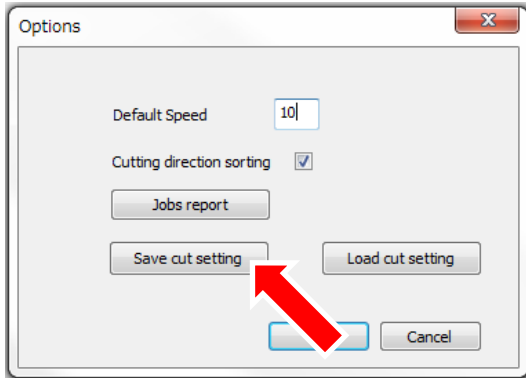

2. The folder for saving the settings of iMark Plus software will be displayed.

NOTICE

- The folder which cut counter shape graphics file loaded into the iMark Plus software is saved is automatically displayed.

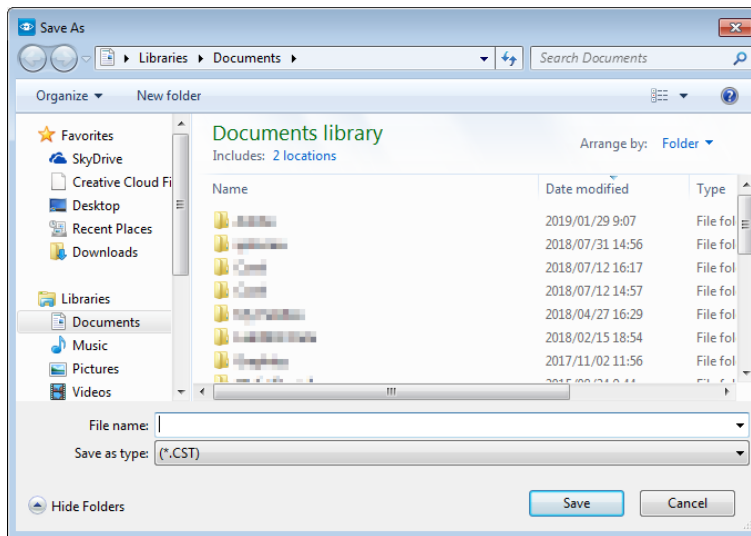

3. Input the file name for saving the settings of iMark Plus software into the "File name". And then click the "Save" button to save.

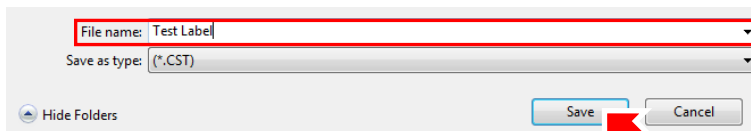

NOTICE

- Use only alphabets and numbers for file name do not use 2 byte characters.
- The file extension is automatically selected "CST" do not change it.

5 Load cut setting

It can be load the saved settings into the iMark Plus software with following procedure.

NOTICE

- Can not save the number of copies.

1. Click the "Load cut setting" button.

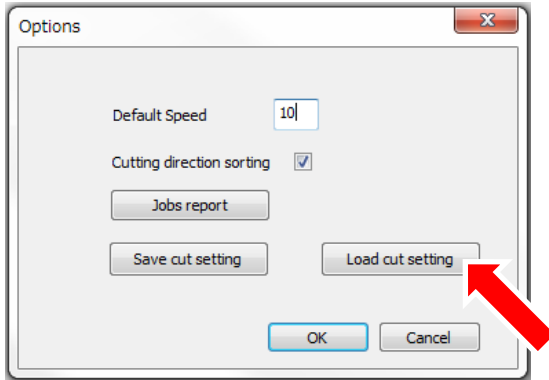

NOTICE

- The saved iMark Plus software settings file can not be loaded without loading the cut contour shape graphics file into the iMark Plus software.

2. The folder which cut counter shape graphics file loaded into the iMark Plus software is saved will be displayed.

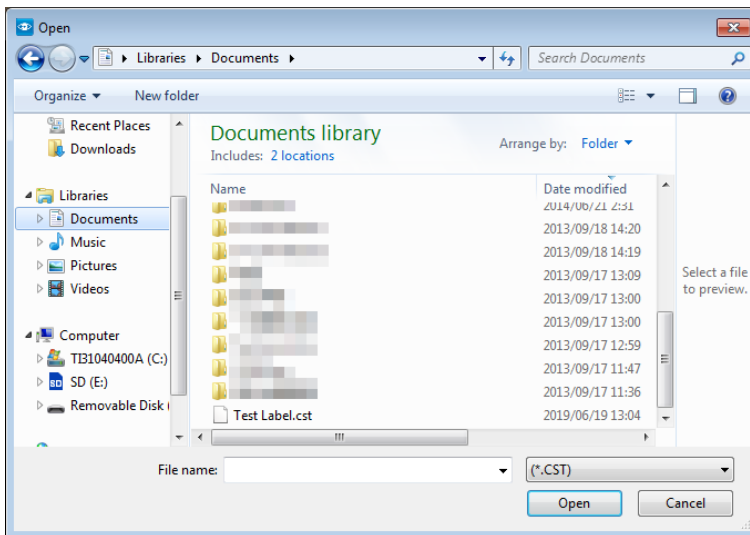

3. Click and select the saved iMark Plus software settings file (.CST).
And then click the "Open" button to loading the settings into the iMark Plus software.

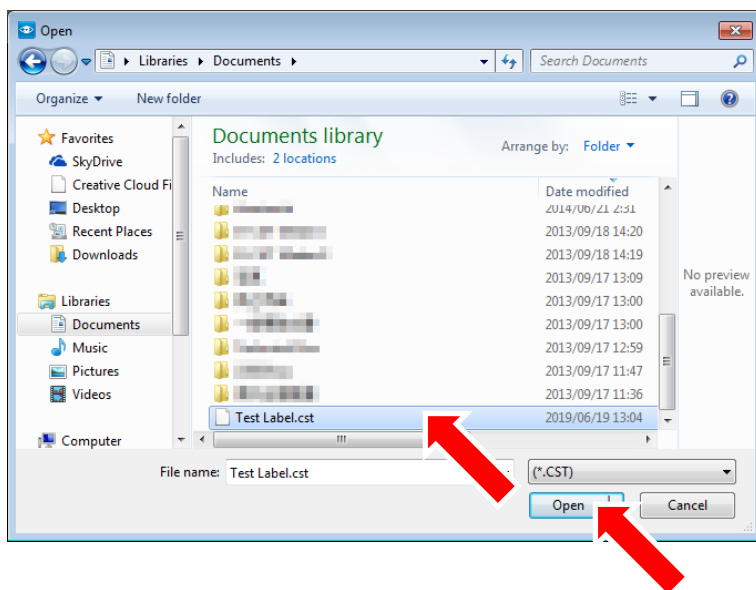

4. After loading the settings into the iMark Plus software, the name of settings file will be displayed next to the iMark Plus software window.

