

FCX2000 SERIES

CUTTING PLOTTER

USER'S MANUAL

MANUAL NO.FCX2000-UM-151



GRAPHTEC

TO ENSURE SAFE AND CORRECT USE

- To ensure the safe and correct use of your machine, read this manual thoroughly prior to use.
- After reading this manual, keep it in a handy location for quick reference as necessary.
- Do not allow small children to touch the machine.
- The following describes important points for safe operation. Be sure to observe them strictly.

Conventions Used in This Manual

To ensure the safe and accurate use of the machine as well as to prevent human injury and property damage, the safety precautions provided in this manual are ranked in the three categories described below. Their display and meaning is as following. Be sure to gain a full understanding of the meaning of them before reading the Manual.



DANGER

This category provides information that, if ignored, is highly likely to cause fatal or serious injury to the operator.



WARNING

This category provides information that, if ignored, is likely to cause fatal or serious injury to the operator.





CAUTION



This category provides information that, if ignored, could cause injury to the operator or damage to the machine.

Description of Safety Symbols





The  symbol indicates information that requires careful attention (including warnings). The specific point requiring attention is described by an illustration or text within or next to the  symbol.



The  symbol indicates an action that is prohibited. Such prohibited action is described by an illustration or text within or next to the  symbol.



The  symbol indicates an action that must be performed. Such imperative action is described by an illustration or text within or next to the  symbol.

Safety Precautions

! WARNING

During a cutting/operation, do not touch the roller, tool carriage, and other moving parts.

- Such action may cause human injury.



No touching

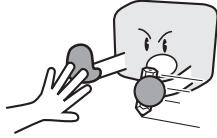

During a cutting/operation, be sure to keep your hands, hair, and so forth away from the roller, tool carriage, and other moving parts.

- Such action may cause human injury.



No touching

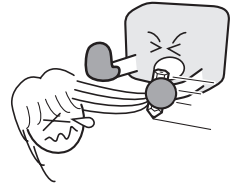

Even when the machine is stopped, it may suddenly start operating if it receives data, so be sure to keep your hands, hair, and so forth away from the vicinity of the roller, tool carriage, and other moving parts.

- Such action may cause human injury.



No touching

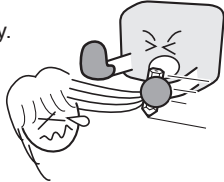

Make sure that the machine is grounded.

- If the plotter is not grounded, the operator could suffer an electrical shock in case of current leakage.



Ground the Machine

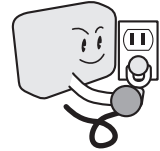

Do not connect the machine to a non-rated power supply.

- Use of a different supply voltage may result in electrical shock or a fire hazard due to current leakage.



Prohibited

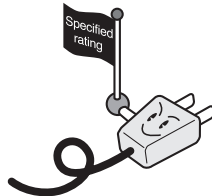

Do not disassemble or remodel the machine.

- Such action may result in electrical shock or a fire hazard due to current leakage.
- Contact with the high-voltage parts within the machine may cause electrical shock.
- Contact your sales representative or nearest Graphtec vendor to request repair.



No disassembly



If the machine generates smoke, is too hot, emits strange odor, or otherwise functions abnormally, do not continue using it. Turn off its power and unplug its power cord from the electrical socket.

- Use of the machine in such status may result in a fire hazard or electrical shock.
- After confirming that smoke is no longer being generated, contact your sales representative or nearest Graphtec vendor to request repair.
- Never try to perform repair yourself. Repair work by inexperienced personnel is extremely dangerous.



Prohibited

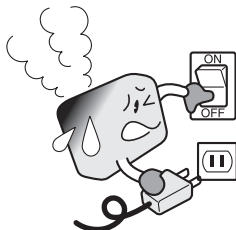

Do not use the machine in a location where it will be exposed to water, rain or snow.

- Such action may result in electrical shock or a fire hazard due to current leakage.



Avoid water



Beware of electrical shock

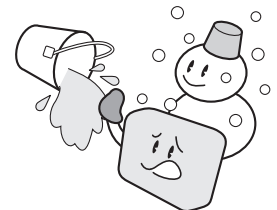

Safety Precautions

WARNING

Do not allow dust or metallic matter to adhere to the power plug.

- Such action may result in electrical shock or a fire hazard due to current leakage.



Prohibited



Beware of electrical shock

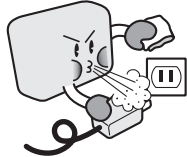

Do not use the power cord if it is damaged.

- Use of a damaged cord may result in electrical shock or a fire hazard due to current leakage.
- Replace the power cord with a new one.



Unplug the power cord from the socket



Handle cutter blades with care.

- Avoid direct contact with the cutter blade. Touching the blade with your bare hand may cause injury.
- During a cutting operation, keep away from the cutter blade.



No touching

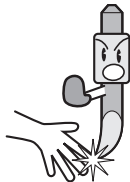

Safety Precautions

⚠ CAUTION

Do not use or store the machine in a location exposed to direct sunlight or the direct draft of an air conditioner or heater.

- Such locations may impair the performance of the machine.



Prohibited

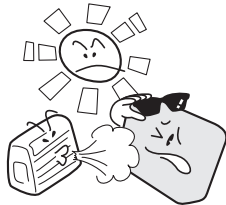

Do not use or store the machine outdoors or in an excessively dusty or humid location.

- Such locations may impair the performance of the machine.



Prohibited

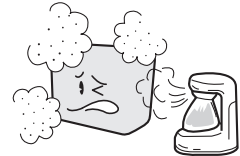

Do not place a coffee cup or any other receptacle containing water or other fluid on top of the machine.

- Fluid falling inside the machine may cause electrical shock or a fire hazard due to current leakage.



Avoid water



Beware of electrical shock



Do not install, use, or store the machine in a location subject to excessive mechanical vibration or electrical noise.

- Such locations may impair the performance of the machine.



Prohibited

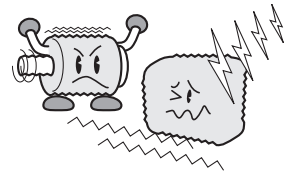

When disconnecting the power cord or an interface cable, do not pull on the cord/cable.

- Such action will damage the cord/cable, resulting in a fire hazard or electrical shock.



Prohibited

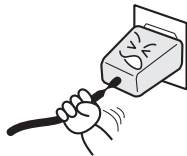

If water or foreign matter enters inside the machine, do not continue using it. Turn off its power and unplug its power cord from the electrical socket.

- Use of the machine in such a status may result in electrical shock or a fire hazard due to current leakage.
- If the machine requires repair, contact your sales representative or nearest GRAHTEC vendor.



Unplug the power cord from the socket

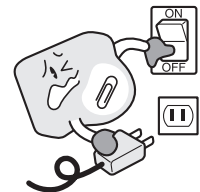

Do not clean the machine using a volatile solvent (such as thinner or benzene).

- Such action may impair its performance.



Prohibited

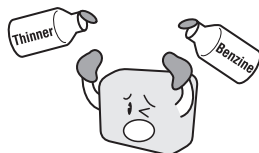

Do not place magnetic cards, diskettes or similar items in the vicinity of the tool carriage.

- The magnetic force may destroy the data on the magnetic cards or diskettes.



Prohibited

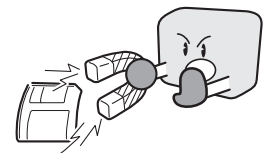

Safety Precautions

⚠ CAUTION

Do not attempt to lubricate the machine's mechanisms.

- Such action may cause it to break down.



Prohibited

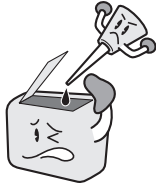

Provide sufficient space around the machine so that the media does not strike any objects in the machine's vicinity during cutting or plotting.

- Such contact may cause cutting to go out of alignment.



No touching

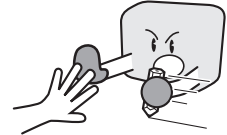

Do not place the machine on an incline, areas subject to many vibrations, or other unstable locations.

- If the machine falls, it may cause human injury.



Prohibited



When using the cutter pen, take care not to extend the cutter blade excessively.

- An excessive blade length will damage the writing panel and impair the machine's cutting quality.

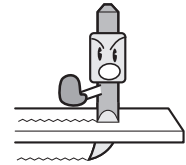

Move the pen carriage slowly when moving it manually in order to load the medium or for other reasons.

- Moving it quickly may damage the machine.

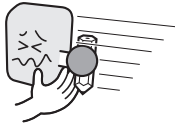

When using indoor lighting such as fluorescent lamps and desk lamps, make sure the machine is separated by at least 1 m.

- Placing the machine too close to such lighting may cause sensor malfunctions and the paper detection to not function efficiently.



Run a test cut when cutting materials with unknown condition settings.

- Running a cut operation with incorrect setting values may cause a large overload to the blades and device or a system breakdown.



Before use, check that the power can be turned off by pressing the Emergency Stop Switch.

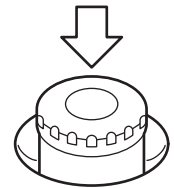

Preface

Thank you for choosing a Graphtec FCX2000 Series plotter.

The FCX2000 Series plotters employ a digital servo drive system to achieve high-speed and high-precision cutting.

To ensure high cutting quality and optimal productivity, be sure to read this User's Manual thoroughly prior to use.

Notes on this Manual

- (1) No part of this publication may be reproduced, stored in a retrieval system, or transmitted, in any form or by any means, without the prior written permission of Graphtec Corporation.
- (2) The product specifications and other information in this manual are subject to change without notice.
- (3) While every effort has been made to provide complete and accurate information, please contact your sales representative or nearest Graphtec vendor if you find any unclear or erroneous information or wish to make other comments or suggestions.
- (4) Not with standing the stipulations in the preceding paragraph, Graphtec Corporation assumes no liability for damages resulting from either the use of the information contained herein or the use of the product.

Registered Trademarks

All names of companies, brands, logotypes, and products appearing in this manual are the trademarks or registered trademarks of their respective companies.

Copyright

This User's Manual is copyrighted by Graphtec Corporation.

Special Precautions on Handling Blades

Sharp cutter blades are used with this plotter. Handle the cutter blades and plungers with care to prevent bodily injury.

The cutter blade must be discarded correctly according to local regulations/laws.

Cutter Blades

Cutter blades are very sharp. While handling a cutter blade or cutter pen, be careful to avoid cutting your fingers or other parts of your body. Promptly return used blades to the cutter case provided.

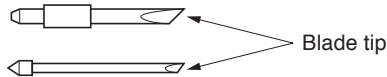

When the case is completely filled, discard the used blades together with the case.

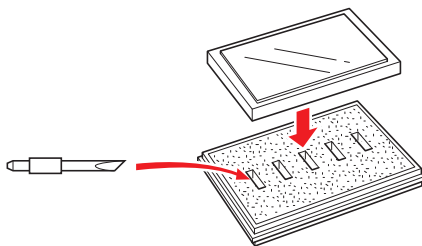

Cutter Plungers

The tip consists of a sharp blade. Be sure not to extend it too far. Moreover, when you are not using the cutter plunger, make sure that the blade is fully retracted.

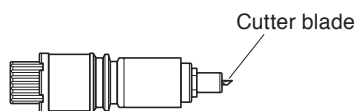

After Mounting the Cutter Pen

After the power has been turned on, and during operation, do not touch the pen tip. It is dangerous.

Paper-securing blower pump

FCX2000-60VC, FCX2000-120VC and FCX2000-180VC require a blower pump to secure a paper.

Depending on the blower pump to be used, the cutting quality might be degraded or the plotter body might be damaged.

Please use the blower pump conforming to the genuine optional accessories.

Or, please contact the distributor.

After Turning on the Plotter

During operations, immediately after completion of operations, and when setting the cutting plotter functions, the pen carriage, Y bar, and other parts which are not fixed, may move suddenly. Do not let your hands, hair, or clothing get too close to the moving parts or within their range of movement. Do not place any foreign objects in or near these areas either. If your hands, hair, clothing, or the like get caught in, or wrapped around moving parts, you may be injured and the machine may be damaged.

Machine Caution Label

The machine's Caution Label is located on the top cover. Be sure to observe all the cautions on the label.



Notes on the Stand

Be sure to use only the stand designed for the FCX2000 Series. The use of a different stand may cause a plotter malfunction or bodily injury.

About the words and phrases in this text

- In this instruction manual, the word "plot" refers to operating the machine and using either the plotting pen or the cutter plunger to cut.
- In this instruction manual, the word "media" refers to paper, roll media, sheet media, or marking film.

Prior to use

Be sure to read the attached TO ENSURE SAFE AND CORRECT USE prior to use. Otherwise, it may cause an unexpected accident or fire.

Precautions when using the curled media

If the media floats, secure the four corners using a drafting tape.

When the media is floating, if the plunger tip (cutter blade or ballpoint pen) has contact with it, it can affect the finish quality.

Or, the plotter body might be damaged.

Please fix the warping of the media, or do not use the warped media.

Installation Space

Please secure a space for installation as according to the below illustration.

⚠ CAUTION

Leave sufficient space for operations in front of and behind the plotter.

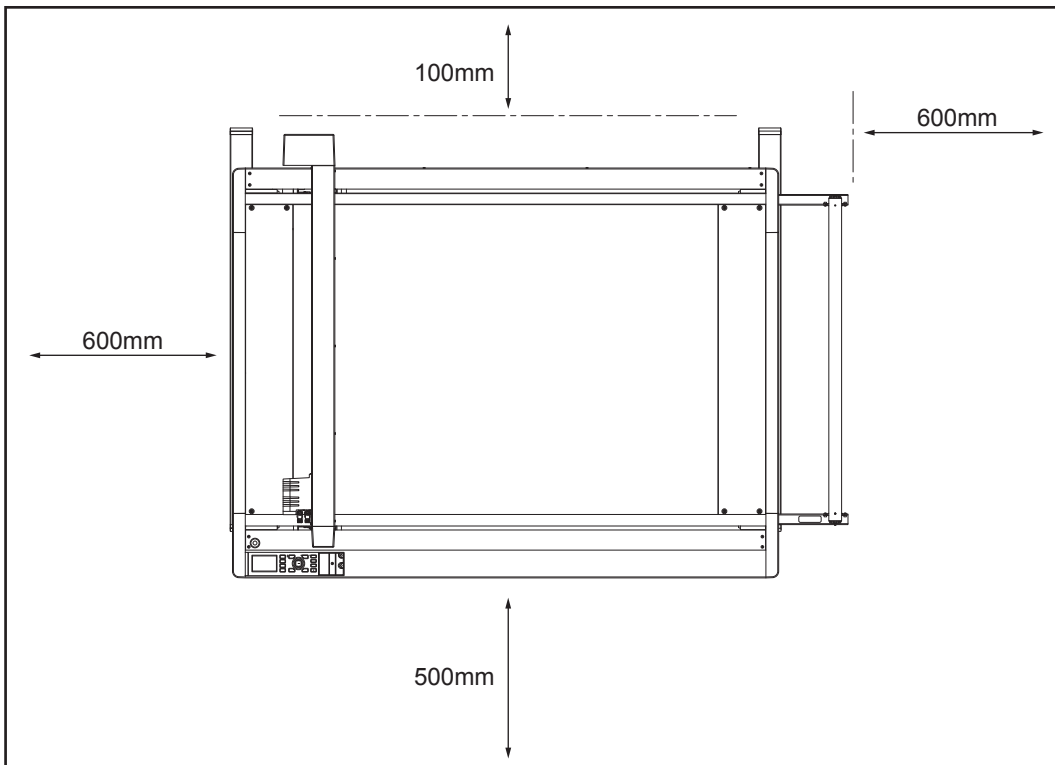

About the words and phrases in this text

- In this instruction manual, the word "plot" refers to operating the machine and using either the plotting pen or the cutter pen to cut.
- In this instruction manual, the word "media" refers to paper, roll media, sheet media, or marking film.

Prior to use

Be sure to read the attached TO ENSURE SAFE AND CORRECT USE prior to use. Otherwise, it may cause an unexpected accident or fire.

About the words and phrases in this text

- The media jamming occurs when strongly curling media is used.
- Please use uncurling media or remove the curling from the media before installing such kind of media.

WARNING

The United States Federal Communications Commission has specified that the following notice must be brought to the attention of users of this product.

FEDERAL COMMUNICATIONS COMMISSION RADIO FREQUENCY INTERFERENCE STATEMENT

NOTE: This equipment has been tested and found to comply with the limits for a Class A digital device, pursuant to part 15 of the FCC Rules. These limits are designed to provide reasonable protection against harmful interference when the equipment is operated in a commercial environment.

This equipment generates, uses, and can radiate radio frequency energy and, if not installed and used in accordance with the instruction manual, may cause harmful interference to radio communications. Operation of this equipment in a residential area is likely to cause harmful interference in which case the user will be required to correct the interference at his own expense.

USE SHIELDED CABLES

To comply with FCC Class A requirements, all external data interface cables and connectors must be properly shielded and grounded. Proper cables and connectors are available from GRAPHTEC's authorized dealers or manufacturers of computers or peripherals. GRAPHTEC is not responsible for any interference caused by using cables and connectors other than those recommended or by unauthorized changes or modifications to this equipment. Unauthorized changes or modifications could void the user's authority to operate the equipment.

Selecting a Power Cable

Be sure to refer to the following tables if you wish to use a cable other than the one supplied as an accessory.

Table 1. 100 V to 120 V Power Supply Voltage Range

Plug Configuration	Plug Type	Supply Voltage Selector Settings	Reference Standards	Power Cable
	North America 125 V 10 A	100/120 V	ANSI C73.11 NEMA 5-15 UL498/817/62 CSA22.2 NO.42/21/49	UL Listed Type SJT No.18AWG × 3 300 V, 10 A

Table 2. 200 V to 240 V Power Supply Voltage Range

Plug Configuration	Plug Type	Supply Voltage Selector Settings	Reference Standards	Power Cable
	Europe 250 V 10 A	200 V	CEE(7)VII IEC320 CEE13	TYPE: H05VV-F 3 × 1.0 mm ²
	UK 250 V 5 A	200 V	BS1363 BS4491 BS6500	TYPE: H05VV-F 3 × 1.0 mm ²
	Australia 250 V 10 A	200 V	AS3112 AS3109 AS3191	TYPE: OD3CFC 3 × 1.0 mm ²
	North America 250 V 15 A	200 V	ANSI C73.20 NEMA 6-15 UL 198.6	UL Listed Type SJT No.18AWG × 3 300 V, 10 A
	Switzerland 250 V 6 A	200 V	SEV1011 SEV1004 SEV1012	TYPE: H05VV-F 3 × 0.75 mm ²
	China 250 V 6 A	200 V	GB15934 GB2099.1 GB1002 GB/T 5023.5	TYPE: H05VV-F 3 × 1.0 mm ²

CONTENTS

TO ENSURE SAFE AND CORRECT USE	i
Safety Precautions	ii
Preface	I
Notes on this Manual	I
Registered Trademarks	I
Copyright	I
Special Precautions on Handling Blades	II
Cutter Blades	II
Cutter Plungers	II
After Mounting the Cutter Pen	II
Paper-securing blower pump	III
After Turning on the Plotter	III
Machine Caution Label	III
Notes on the Stand	IV
About the words and phrases in this text	IV
Prior to use	IV
Precautions when using the curled media	IV
Installation Space	V
About the words and phrases in this text	VI
Prior to use	VI
About the words and phrases in this text	VI
WARNING	VI
FEDERAL COMMUNICATIONS COMMISSION RADIO FREQUENCY INTERFERENCE STATEMENT	VI
USE SHIELDED CABLES	VI
Selecting a Power Cable	VII

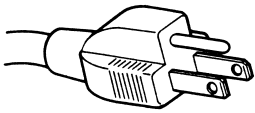
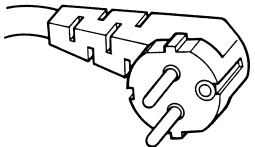
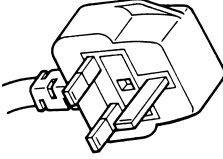
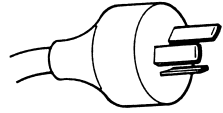
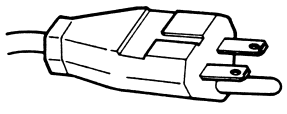
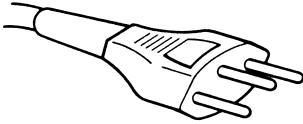
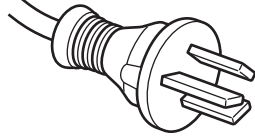
Chapter 1: Product Summary

1.1 Checking the Accessories	1-2
Accessories	1-2
Accessories (VC model only)	1-3
Accessories (MG model only)	1-3
1.2 Nomenclature	1-4
Emergency Stop Switch	1-5
1.3 Connecting to the Computer	1-6

Chapter 2: Preparing to Cut

2.1 Preparation of Cutter Plunger	2-2
Cutter Plunger Nomenclature	2-2
Structure of Cutter Plunger	2-2
Adjusting the Blade Length	2-3
2.2 Attaching a Tool	2-4
Attaching a Tool	2-4
Removing the tool	2-5

2.3	Adjusting the Tool Carriage Height.	2-6
2.4	How to Use the Control Panel	2-7
	Indicator Lamp	2-7
	Control key	2-7
	Reading the Screen (LCD)	2-8
	Contents of Operation from Menu Screen	2-10
	Contents of Operation from [COND/TEST] Key	2-11
2.5	Loading the Media	2-12
2.6	Connecting to the Power	2-13
2.7	About the Initial Setup Screen	2-15
2.8	Selecting Tool Condition	2-16
	LCD Display	2-16
	Selecting the tool condition number	2-16
	Setting the Tool Condition	2-18
	Setting the Tool	2-19
	Setting the Creasing Mode	2-20
	Setting the Speed	2-23
	Setting the Force	2-24
	Setting the Acceleration	2-25
	Adjust the Blade Length	2-26
2.9	Running Cutting Tests	2-27
	Cutting Test	2-27
	To make 1 cut with set value	2-27
	To make 3 cuts with set value and ± 1 of set value	2-28
	Confirm the Results of the Cutting Test	2-29
	Adjustment of Offset	2-29
	Adjustment for Half Cutting	2-29
	Adjustment for Cutting Out	2-29
	Adjustment When Using Plotting Pen	2-29
	Adjust the Blade Length (Automatic Height Adjust)	2-30
2.10	Display Cutting Area.	2-33

Chapter 3: Basic Operations

3.1	Raise or Lower the Tool	3-2
3.2	Move the Tool Carriage	3-3
	Move in Steps Manually	3-3
	Continuously Move Manually	3-3
	Setting of Step Movement Distance	3-4
	Move Away the Tool Carriage	3-5
	Change the Cutting Condition (Condition No.)	3-6
	Reset (Revert to the initial state when the power was turned on.)	3-6
3.3	Setting the Origin Point	3-7
	When Coordinate Axes Rotation are Set	3-8
	Setting Origin Point When HP-GL is Set	3-9
3.4	Setting the Cutting Direction	3-10
3.5	Stop Cutting	3-12
	Pause and Resume Cutting	3-12
	Stop Cutting	3-13

Chapter 4: Convenient Functions

4.1 Settings for Cutting	4-2
Setting Cutting Area	4-2
Setting Mirror	4-4
Set the enlarge/shrink scale (Scale)	4-5
4.2 Copy (Duplicate Cutting)	4-7
When Cutting Data Has No Registration Mark	4-7
When Cutting Data Has Registration Marks	4-9
4.3 Dual Configuration	4-12
Selecting the user	4-12

Chapter 5: ARMS (Advanced Registration Mark Sensing System)

5.1 Outline of ARMS	5-2
Shape (Pattern) of the Registration Mark	5-2
Scan Range Necessary to Sense the Registration Mark	5-3
Position of the Origin Point and the Registration Mark	5-5
Cutting area when adjusting the registration mark	5-6
Automatic sensed of registration mark position	5-6
Media That Registration Mark Cannot be Sensed	5-7
5.2 Setting and Adjustment of ARMS	5-8
Setting MARK SCAN MODE and Numbers	5-8
Setting Shape (Pattern) of Registration Mark	5-13
Setting Distance Adjustment Between the Registration Marks	5-15
Setting Registration Mark Size	5-17
Setting Mark Distance	5-18
Setting Offset Between the Registration Mark and Cutting Origin Point	5-20
Adjusting for the Registration Mark Scan Position	5-23
Adjust After Plotting the Adjustment Registration Mark	5-23
Sense the Registration Mark for Adjustment on the Media and Enter the Value	5-26
Adjusting the Sensor Level	5-29
Setting the registration mark automatic sensing	5-31
Setting Speed of the Registration Mark Scan	5-32
Setting the Scanning Method When Registration Marks are Scanned ("ISM"/"NORMAL")	5-33
Setting Scan Step When Registration Marks Are Scanned	5-34
Manually Adjusting the Sensor Level (Threshold Value)	5-36
Test the Registration Mark Sensor	5-38
5.3 Setting the Position Using ARMS	5-40
Adjust with 2POINTS	5-40
Adjust with 3POINTS	5-42
Adjust with 4POINTS	5-43
Adjust Automatically	5-45
Adjust Manually	5-46

Chapter 6: Manual Position Adjust

6.1 Outline of Manual Position Adjust	6-2
Setting of MARK SCAN MODE and Number of Adjustment Marks	6-2
6.2 Manual Position Adjust	6-3

Chapter 7: ARMS Setting Regarding Cutting Quality

7.1 To cut the corner of thick media sharply	7-2
Outline of Tangential Mode	7-2
Setting the Tangential Mode	7-3
Setting the Length of Overcut	7-4
Setting the Initial Down Force	7-6
7.2 Setting the Step Pass	7-8
7.3 Setting the Offset Angle	7-10
7.4 Setting the Distance Adjust	7-12
7.5 Setting Cut Line	7-14
7.6 Setting the Initial Blade Angle Position	7-18
7.7 Settings for OFFSET FORCE	7-20
7.8 Setting the Overlay Cut Function	7-21

Chapter 8: ARMS Settings Regarding Cutting Time

8.1 Sorting the Cutting Data	8-2
8.2 Setting the Tool Up Move	8-4
8.3 Setting the Tool Up Speed	8-6
8.4 Setting the Tool Up Height	8-8

Chapter 9: ARMS Setting Regarding Interface

9.1 Setting the Interface	9-2
USB Interface	9-2
Network (LAN) interface	9-2
RS-232C Interface	9-3
9.2 Clearing the Buffer Memory	9-4
9.3 I/F (LAN)	9-5
Set the DHCP	9-5
Set IP address, Subnet Mask and Gateway	9-7
9.4 When Connecting the RS-232C Interface	9-10
Switching Setting Numbers	9-10
Changing and Storing RS-232C Settings	9-11

Chapter 10: ARMS Setting Regarding Operation Environment

Related to Menu Display	10-2
Display Language Setting (LANGUAGE SELECTION)	10-2
Setting the Display Length Unit (LENGTH UNIT)	10-3
Related to Plotter Environment	10-4
Enabling/Disabling the Beep Setting (BEEP FOR KEY OPERATION)	10-4
Setting the force (SWITCHING XY FORCE)	10-5
Setting the position key low speed (POSI. KEY SPEED + SLOW KEY)	10-6
Setting the position key high speed (POSI. KEY SPEED)	10-7
Setting the display of the position key (TOOL POSITION)	10-8
Setting the pause key (PAUSE/MENU KEY SETTING)	10-9
Setting the user key (USER KEY SETTING)	10-10
Setting the draft mode (DRAFT MODE)	10-11

Chapter 11: ARMS Settings of Controls from Computer

Related to Command Processing	11-2
Setting the Command (COMMAND).....	11-2
Priority of Tool Condition Selection (CONDITION PRIORITY).....	11-3
Enabling/Disabling the Condition Select Command (TOLL SELECT COMMAND).....	11-4
Related to GP-GL Command.....	11-5
Setting the Step Size (GP-GL STEP SIZE).....	11-5
Enabling/Disabling the ':' and ';' Commands (COMMAND ':' ';').....	11-6
Moving the Pen While Raised or Lowered in Response to the 'W' Command (COMMAND 'W')	11-7
Related to HP-GL Command.....	11-8
Model ID Response (HP-GL MODEL EMULATED).....	11-8
Setting the Circle-Command Resolution (CIRCLE RESOLUTION).....	11-9

Chapter 12: Offline Output

12.1 Offline Output from USB Memory.....	12-2
12.2 Output with a Bar Code	12-4

Chapter 13: Maintenance

13.1 Daily Maintenance.....	13-2
Daily Maintenance	13-2
Storing the Plotter	13-2
13.2 Replacing Cutter Blade	13-3
13.3 Cleaning the Cutter Pen.....	13-5
13.4 Replacing the Cutter Plunger	13-6
13.5 Setting the Alarm for Degree of Wear (BLADE WEAR ALARM).....	13-7

Chapter 14: Troubleshooting

14.1 Troubleshooting	14-2
When the Plotter Does Not Operate After Turning the Power On	14-2
When It Does Not Work Right	14-3
When the Cutting Result is Not Good	14-4
Error Messages in GP-GL Command Mode	14-5
Error Messages in HP-GL Command Mode	14-6
ARMS Error Messages	14-8
Other Error Messages	14-11
Caution Message.....	14-14
14.2 Printing the Setting of the Plotter	14-15
14.3 Plotting the Test Pattern.....	14-17
14.4 Plotting the CUTTING PRO	14-19
14.5 Confirming the Cutting Data	14-21
14.7 Plotting the Sample Cut Pattern	14-23
14.7 Self Diagnostic Test	14-25
Reading the Error Message.....	14-26

Appendix

A.1	Main Specifications	A-2
A.2	Options and Supplies	A-3
	Options	A-3
	Supplies	A-3
A.3	External Dimensions	A-4
	FCX2000-60VC	A-4
	FCX2000-120VC/ES/MG	A-5
	FCX2000-180VC	A-6
A.4	Menu Tree	A-7
A.5	Initial Setting	A-14

INDEX	I-1
--------------------	------------

Chapter 1: Product Summary









This chapter explains how to connect this device your computer.

PRODUCT SUMMARY

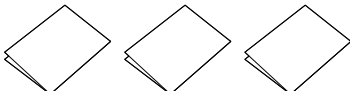
- 1.1** *Checking the Accessories*
- 1.2** *Nomenclature*
- 1.3** *Connecting to the Computer*

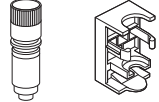

1.1 Checking the Accessories

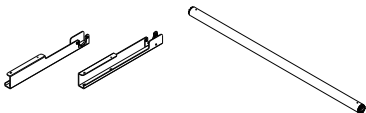
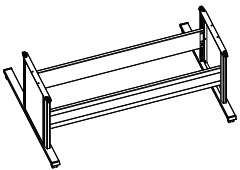
Accessories

Item	Q'ty	Item	Q'ty
Power cable 	1 pc.	USB cable 	1 pc.
DVD  • Various software • User's Manual (pdf)	1 pc.	TO ENSURE SAFE AND CORRECT USE SETUP MANUAL Cutter Blade Manual 	1 set
Cutter plunger (PHP35-CB15-HS) 	1 pc.	Cutter blades: CB15U-2, CB15U-K30-5 	1 of each
Water-based fiber pen adapter (PHP31-FIBER)  Plunger/Height adjustment tool	1 set	Water-based fiber pen (KF700-BK [1P]) 	1 pc.
Cutter blade adjustment magnifier (PM-CT-001) 	1 pc.	Height adjustment plates, Hexagon driver 	1 set
Media stocker 	1 set	Stand 	1 set

* Other guide for the accessory may be attached.

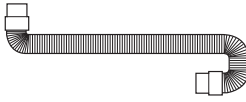
Accessories (VC model only)

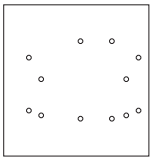
Item	Q'ty	Item	Q'ty
Blower hose 	1 pc.	Hose band 	1 set
Blower mounting stand 	1 pc.		

Accessories (MG model only)

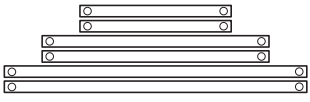
Item	Q'ty		
Sheet-pressing plate 	1 set		

1.2 Nomenclature

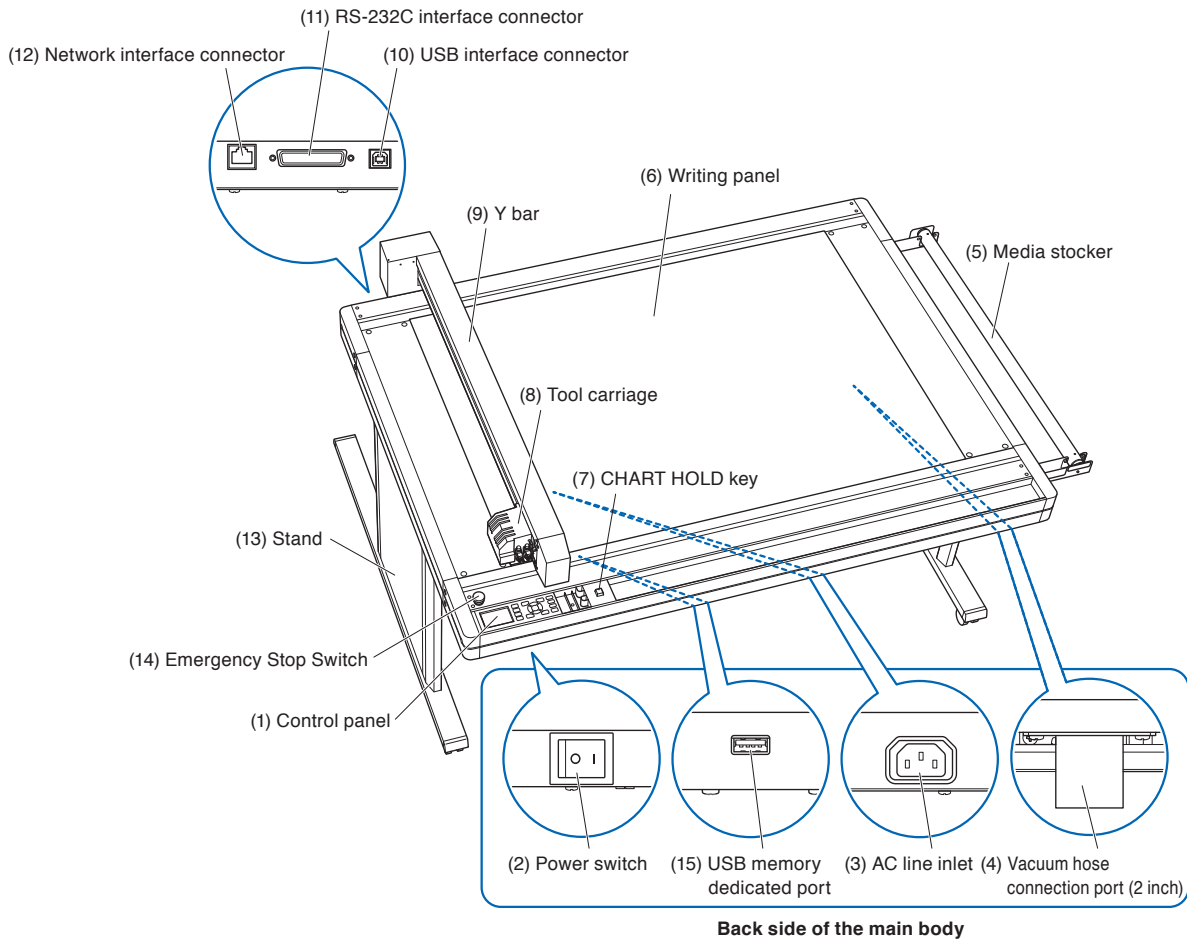

- (1) Control panel Used to access various plotter functions.
- (2) Power switch Used to turn the plotter on and off.
- (3) AC line inlet Inlet where the power cable is connected.
- (4) Vacuum hose connection port Connect to the blower with a hose. (2 inch) (VC model only)
- (5) Media stocker Set a roll paper (media material) after passing the shaft through the roll paper.
- (6) Writing panel Cutting/Plotting/Creasing work is performed on the panel.
- (7) CHART HOLD key Lamp lights up when the [CHART HOLD] key is pressed, you can see that the electrostatic adsorption is functioning. Lamp is turned off by pressing again, the electrostatic adsorption is released. (ES model only)
- (8) Tool carriage Part to drive the cutter/pen.
- (9) Y bar Holds the tool carriage; moves left/right.
- (10) USB interface connector Used to connect the plotter to the computer with a USB interface cable.
- (11) RS-232C interface connector Used to connect the plotter to the computer with a RS-232C interface cable.
- (12) Network (LAN) interface connector .. The connector used when connecting this plotter with the network (LAN) interface cable.
- (13) Stand A stand to put the machine on.
- (14) Emergency Stop Switch Press to stop the unit. Please use this in case of emergency.
- (15) USB memory dedicated port The port that is used only for the USB memory.

Emergency Stop Switch

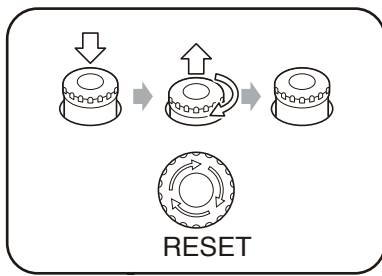

Only use this in case of emergency or check before use.

Pressing the switch will cause the switch to become depressed.

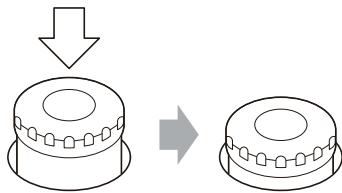

In this state, turning the power switch to the On position ("I" side) will not turn the power on.

Cautionary notes for turning power on again

Be sure to confirm that the power switch is in the Off ("O" side) position.

When the power switch is in the Off position, you can turn it On by turning the emergency stop switch clockwise until you hear the click and the switch pops up.

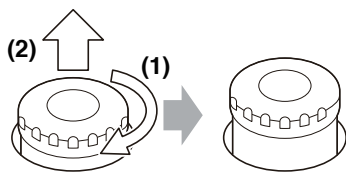

After confirming safety, turn the unit's power switch to the On ("I" side) position.

CAUTION

- When turning the power on for the first time after implementing the emergency stop switch, push the switch to the On position strongly.

1.3 Connecting to the Computer

Connect the plotter to the computer using the communication cable. Use either the USB interface, the RS-232C interface or network (LAN) interface to connect the plotter to the computer. Select the port depending on the specification of the software to be used and the availability of the interface port on the computer.

Please install the drive software before connecting.

Depending on the port used, use either the USB cable (standard accessories), the RS-232C cable (sold separately) or network (LAN) cable (sold separately) to connect. Use the cables specified by Graphtec, matching the computer that is to be connected.

Connection

- 1 Make sure that the power switch is turned off (“○” side).

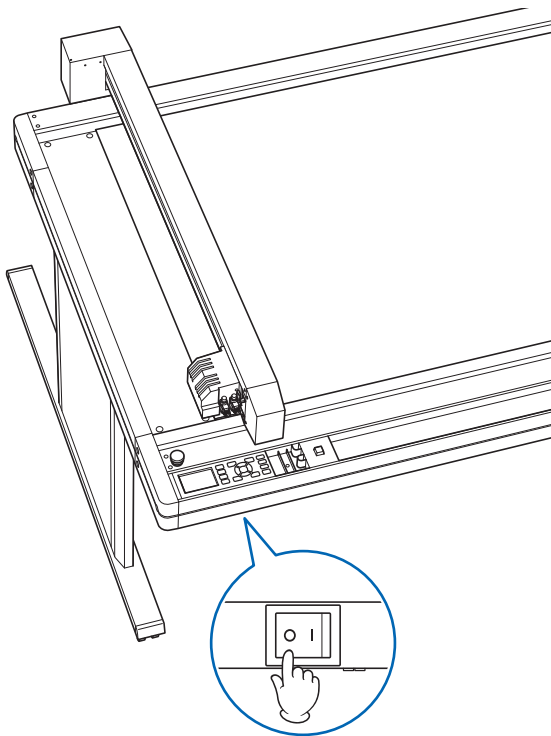

- 2 Connect the plotter to the computer using the interface cable.

Supplement

See "5-1 Setting Interface" for the settings of the interface.

Connection via USB interface

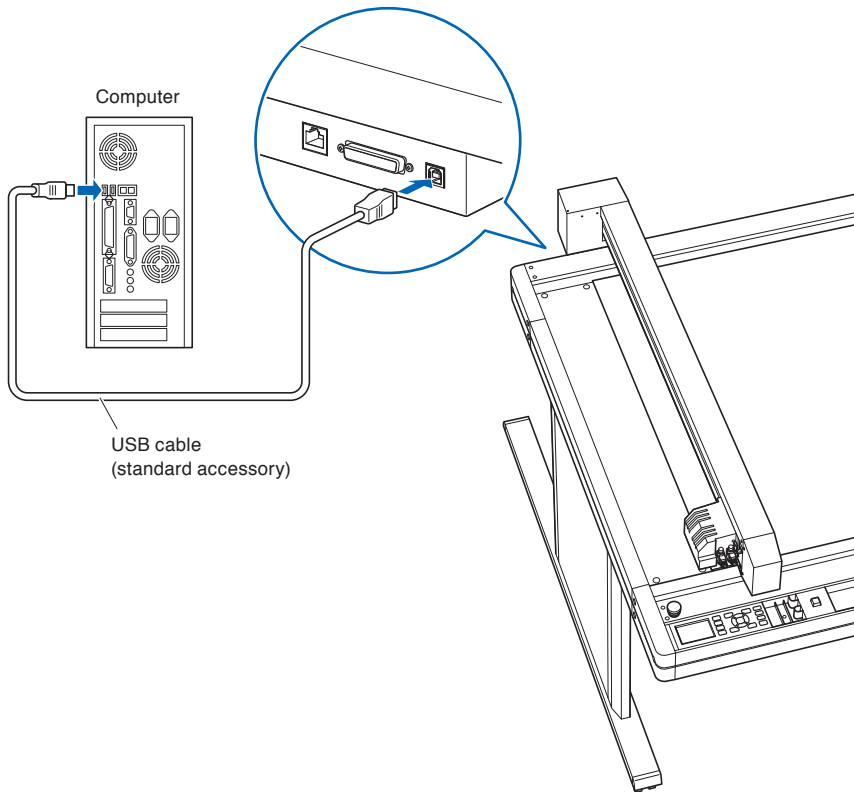

Connection via RS-232C interface

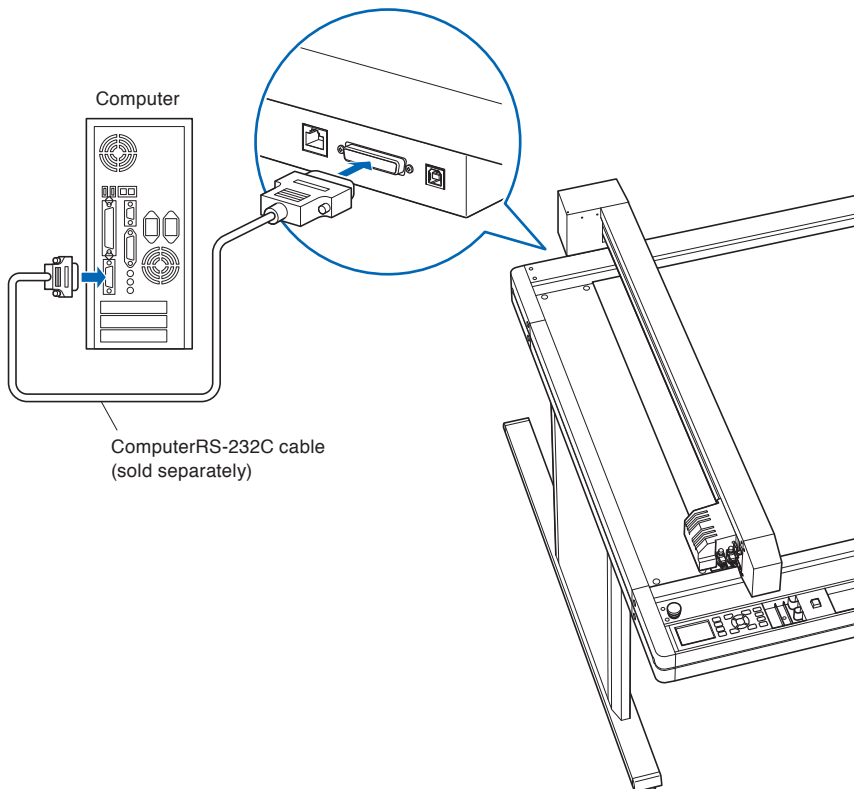

Connection via Network (LAN) interface

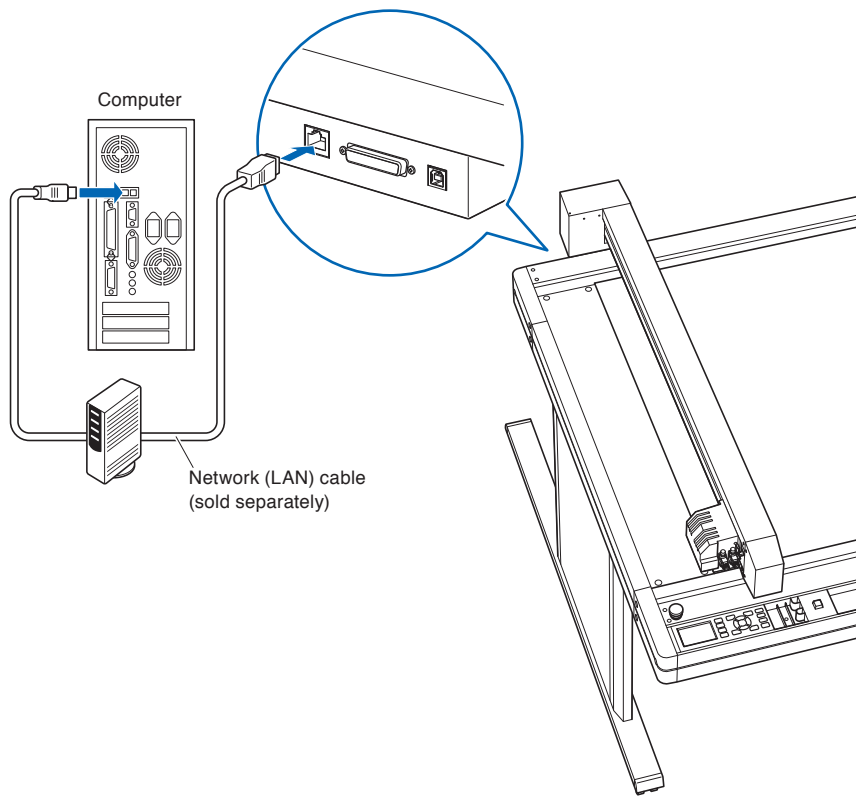

Chapter 2: Preparing to Cut

This chapter describes how to prepare to start the cutting.

PRODUCT SUMMARY

- 2.1** *Preparation of Cutter Plunger*
- 2.2** *Attaching a Tool*
- 2.3** *Adjusting the Tool Carriage Height*
- 2.4** *How to Use the Control Panel*
- 2.5** *Loading the Media*
- 2.6** *Connecting to the Power*
- 2.7** *About the Initial Setup Screen*
- 2.8** *Selecting Tool Condition*
- 2.9** *Running Cutting Tests*
- 2.10** *Display Cutting Area*

2.1 Preparation of Cutter Plunger

This chapter describes the structures and types of the cutter plungers (cutter pens).

Cutter Plunger Nomenclature

There are three different plungers to suit the diameter of the cutter blade to be mounted (the $\phi 1.5$ mm cutter plunger is provided as a standard accessory).

CAUTION

To avoid bodily injury, handle cutter blades with care.

PHP35-CB09-HS/PHP35-CB15-HS

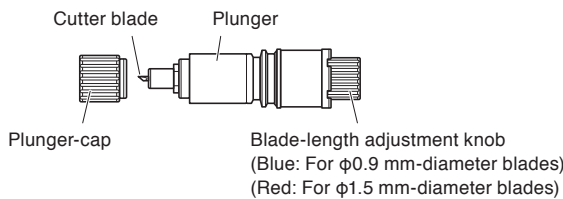

PHP34-CB30-HS

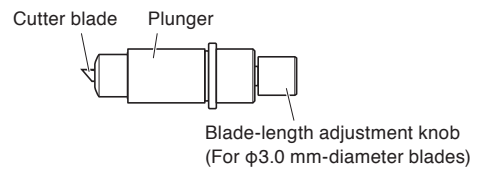

Structure of Cutter Plunger

$\phi 1.5$ mm diameter cutter Plunger

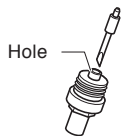
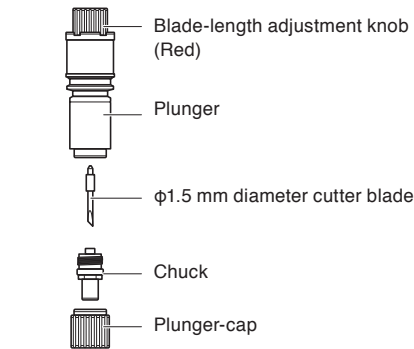

$\phi 0.9$ mm diameter cutter Plunger

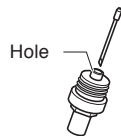
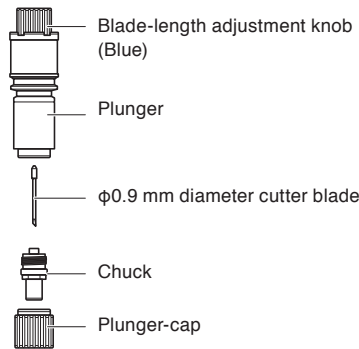

$\phi 3.0$ mm diameter cutter Plunger

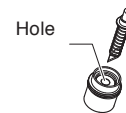
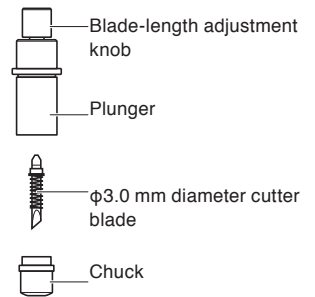

CAUTION

- Please fully insert the cutter blade straight into the chuck.

If the cutter blade cannot be inserted straight, please insert the cutter blade after pressing the insertion port of the cutter blade several times.

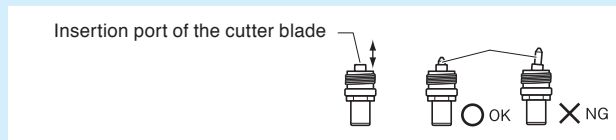

If not installed correctly, it may result in damage to the cutter blade or the plotter itself.

Adjusting the Blade Length

Blade length needs to be adjusted to perform optimal cut. Perform few test cuts and set the optimal blade length.

CAUTION

- To avoid bodily injury, handle cutter blades with care.
- It may result in damaging the cutter blade or the writing panel if the blade is extended too much. Make sure the blade length is set less than the thickness of the media.
Please always perform "test cut" to adjust the blade length.

Supplement

- See "Running Cutting Tests" for cutting tests.
- See "Adjust the Blade Length Manually" for method to manually adjust the blade length.
- If a thin media such as a film is used, use the supplied magnifier to adjust it.

Adjust the blade length by turning the blade-length adjustment knob. Turn the knob in direction "A" to extend the blade, or in direction "B" to retract the blade.

For PHP35-CB09-HS/PHP35-CB15-HS, when the knob is turned the distance of one scale unit, the cutter blade moves approximately 0.1 mm. When the knob is given one full turn, the cutter blade moves 0.5 mm.

For PHP34-CB30-HS, when the knob is turned the distance of one scale unit, the cutter blade moves approximately 0.2 mm. When the knob is given one full turn, the cutter blade moves 0.8 mm.

PHP35-CB09-HS/PHP35-CB15-HS

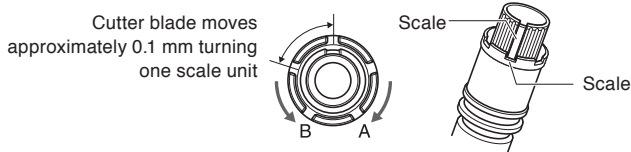

PHP34-CB30-HS

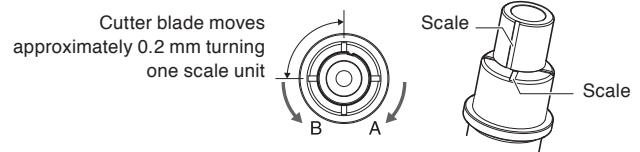

2.2 Attaching a Tool

Attach a tool to the plotter.

Attaching a Tool

When mounting the tool in the tool holder, please note the following.

- Push the tool all the way into the holder until its flange contacts the upper part of the holder and then tighten the screw firmly.
- To prevent injury, avoid absolutely touching the tool immediately after the cutting plotter is turned on or whenever the tool is moving.

It is explained here using cutter plunger as an example.

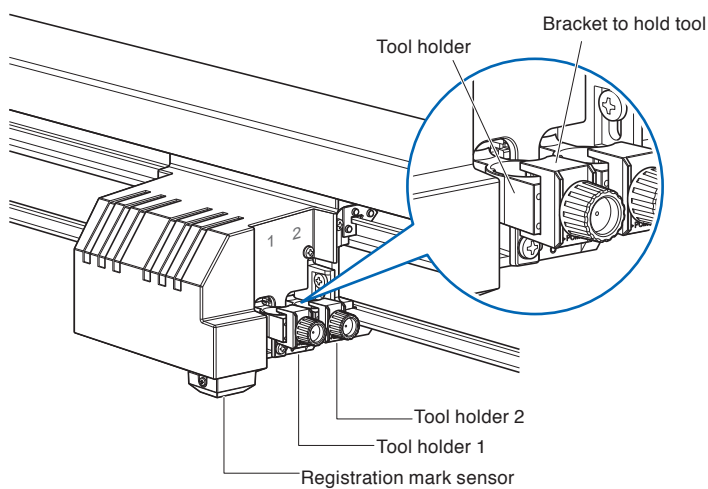

CAUTION

When pushing the tool holder with your fingers, the blade tip may be protruding. Take care not to cut your fingers.

Mounting

- 1 Loosen the tool holder screw.

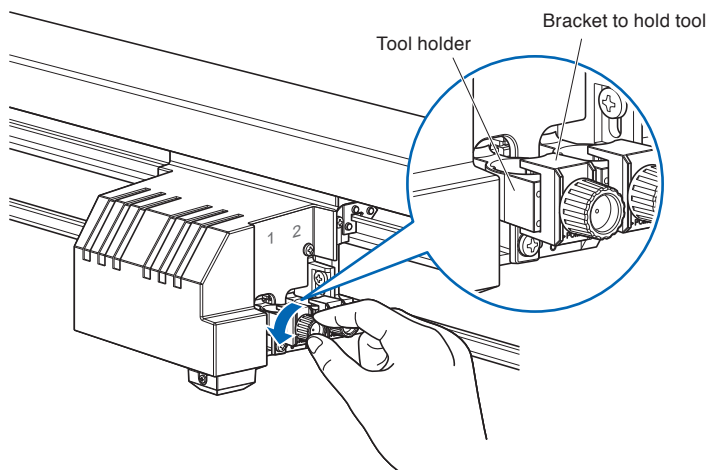

- 2 While pushing up the tool holder, push the tool into the holder until its flange completely touches the upper part of the holder.

CAUTION
When pushing the tool holder with your fingers, the blade tip may be protruding. Take care not to cut your fingers.

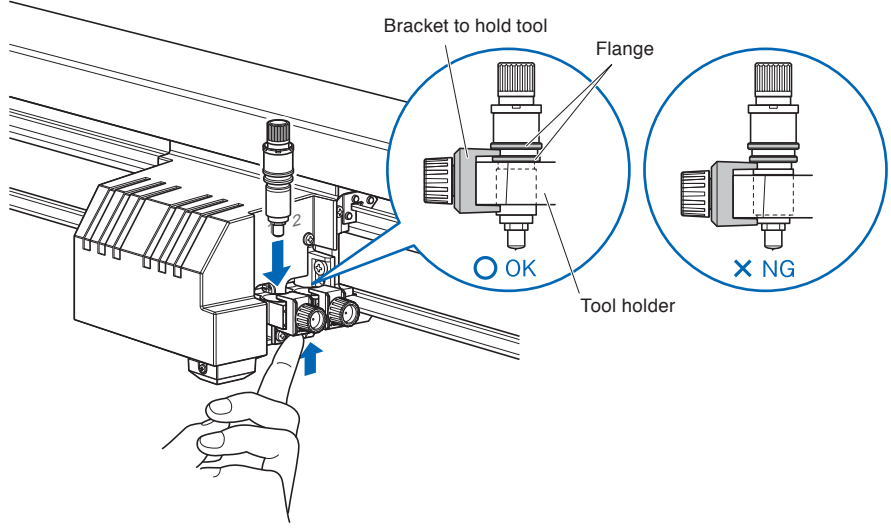

- 3 Make sure that the tool bracket is engaged on the tool's flange, and then tighten the screw.

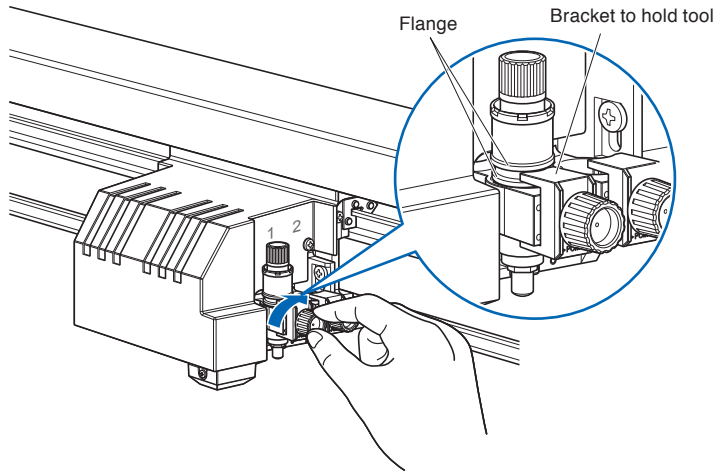

Removing the tool

When removing the tool, turn the tool holder screw counterclockwise to remove the tool.

2.3 Adjusting the Tool Carriage Height

Adjust the height of the tool carriage to suit the thickness of the media.

Supplement

When cutting a thick media, place the media on the writing panel before making this adjustment.

Initial adjustment of the height

- (1) Use the hexagon driver to loosen the two height adjustment bolts.
- (2) When the pen carriage can be moved freely up and down, insert the height adjustment plate (thick) under the pen carriage. Adjust the height of the pen carriage so that the pen carriage rests on top of the plate. Insert the height adjustment plate up to the position where the position adjustment hole can still be seen.

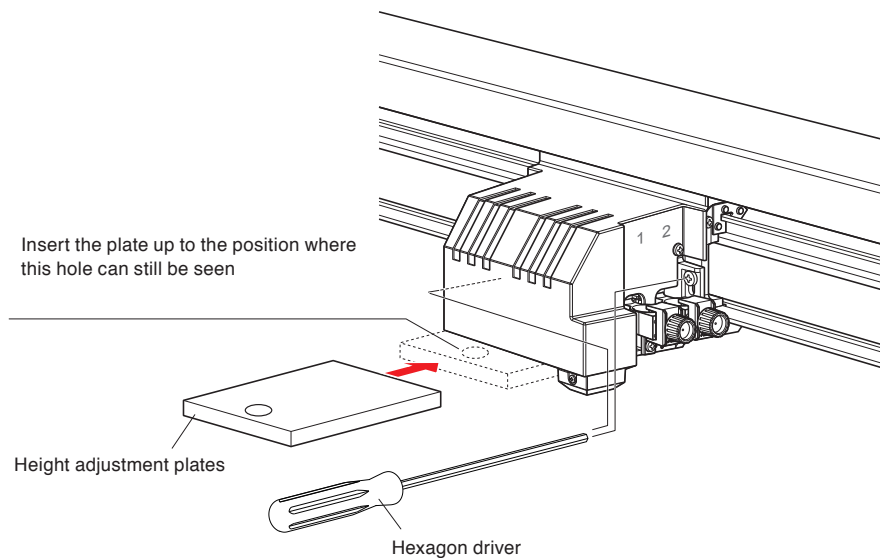

- (3) Use the hexagon driver to tighten the height adjustment bolts. Make sure that the pen carriage is parallel to the writing panel.
- (4) When the adjustment is complete, remove the height adjustment plate (thick) from under the pen carriage.

2.4 How to Use the Control Panel

This section explains the function of lamps and keys on the control panel.

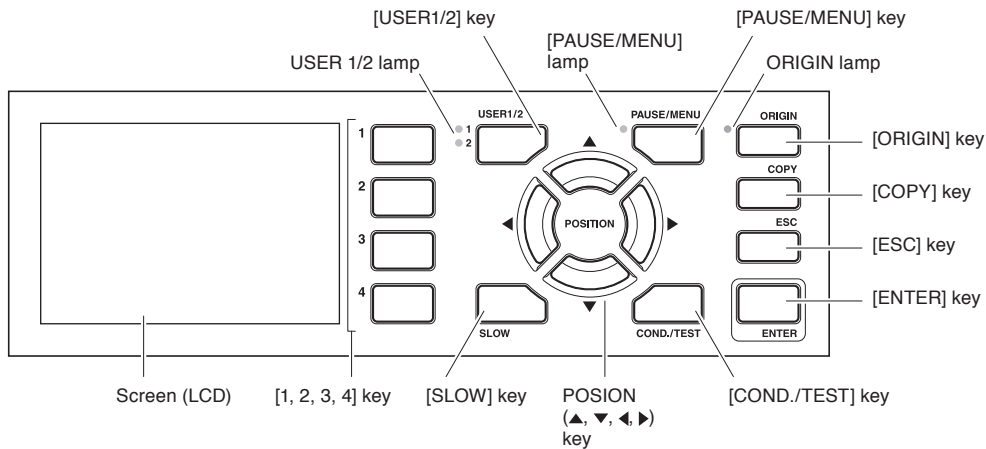

Indicator Lamp

USER 1/2 lamp User lamp that has been selected lights.

PAUSE/MENU lamp
 Lights at the time of the menu mode.

ORIGIN lamp When the origin point has been saved, the lamp lights.

Control key

USER 1/2 Switches the user selection.

PAUSE/MENU Switches to the MENU mode.

It will go into MENU mode if the key is pressed once, and MENU mode will be turned off when the key is pressed again.

Various functions are set in the MENU mode.

When the PAUSE/MENU key is pressed during the operation, the cutting/plotting operation stops.

ORIGIN Sets the current position as an origin point.

On the READY screen, pressing the [ENTER] and [ORIGIN] keys at the same time will allow you to reset the plotter.

COPY Copy of data in the buffer memory is output.

ESC Cancels the setting change and then returns to the previous screen in the setting screen. Returns to the previous screen in the menu screen.

ENTER Saves the settings, and then returns to the setting screen in various functions and condition setting screen of the menu screen.

On the READY screen, pressing the [ENTER] and [ORIGIN] keys at the same time will allow you to reset the machine.

COND/TEST Displays the screen to set the tool conditions.

Use this when checking tool conditions to activate a cutting test.

SLOW When pressing the POSITION key at the same time, the tool carriage moves slowly.

When the "SLOW" icon is displayed on the screen, it works as a menu key.

When the [SLOW] key is pressed in the READY screen, the current cutting/plotting area and the position of tool carriage are displayed.

1, 2, 3, 4 Selects the menu number displayed in the screen.

POSITION (▲, ▼, ◀, ▶) key

..... Adjusts various settings, selects numerical value changes, moves the cursor, and changes the positions in the menu screen.

Reading the Screen (LCD)

Information reflecting the status will be displayed in the screen of the control panel.

Name of the button and corresponding function are displayed on the screen when a function is allocated to the button on the control panel. Button name will be displayed in reverse when the button is enabled.

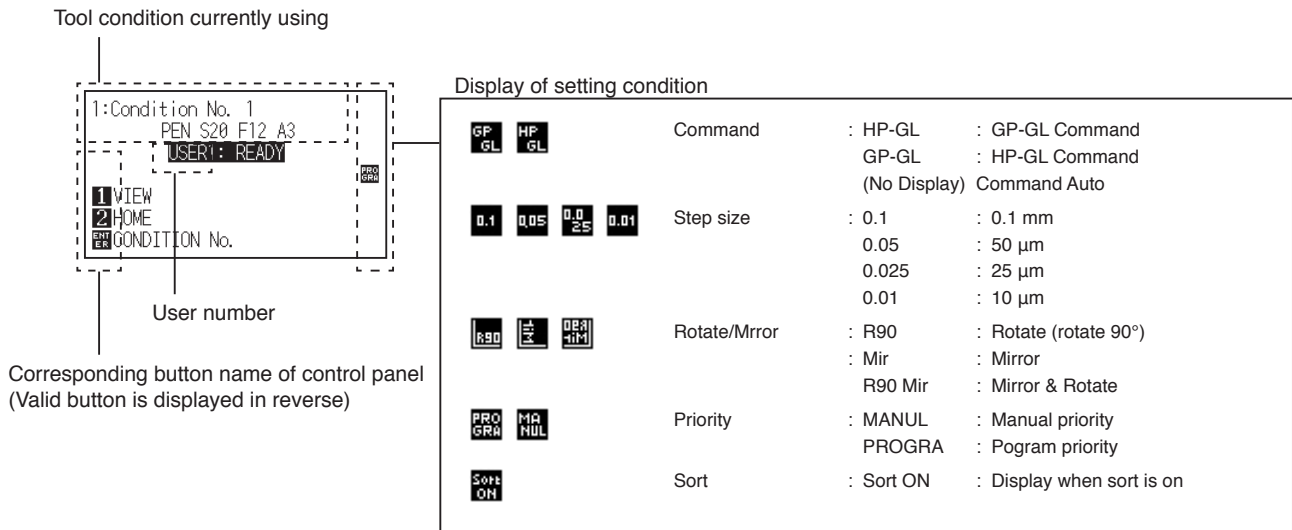
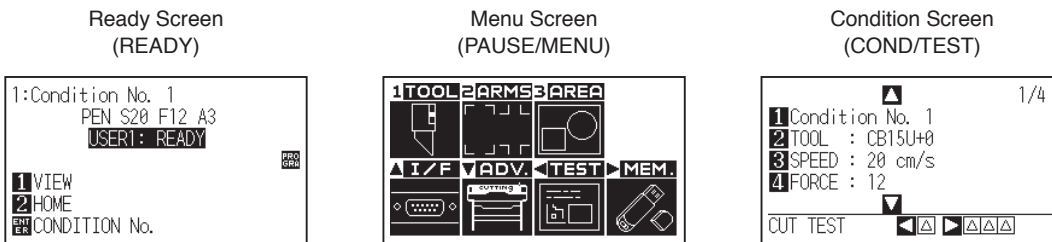

Default Screen (READY Screen)

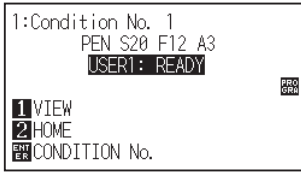

The condition number (Cut Condition) that has been set is displayed.

Supplement

- In this manual, this screen is referred as **READY screen** or **READY status**.
- In this **READY status**, you can set the cutting and communication conditions by pressing **[PAUSE/MENU]** or **[COND/TEST]** key.
- When it is in the draft mode, the **(D)** is displayed after the **READY**.

Screen to set the corresponding conditions is displayed when the **[PAUSE/MENU]** key or **[COND/TEST]** key is pressed.

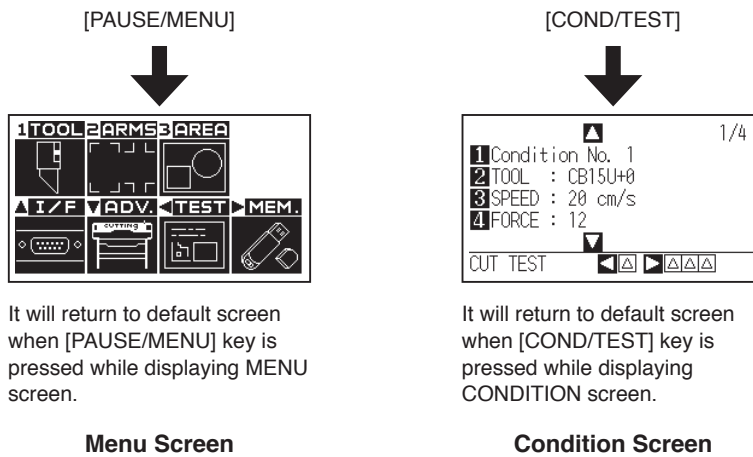

Page number is displayed in the upper right corner of the screen if there are many settings or selection that will need multiple pages to display.

Press the POSITION (**▲ ▼ ◀ ▶**) key to move to different page.

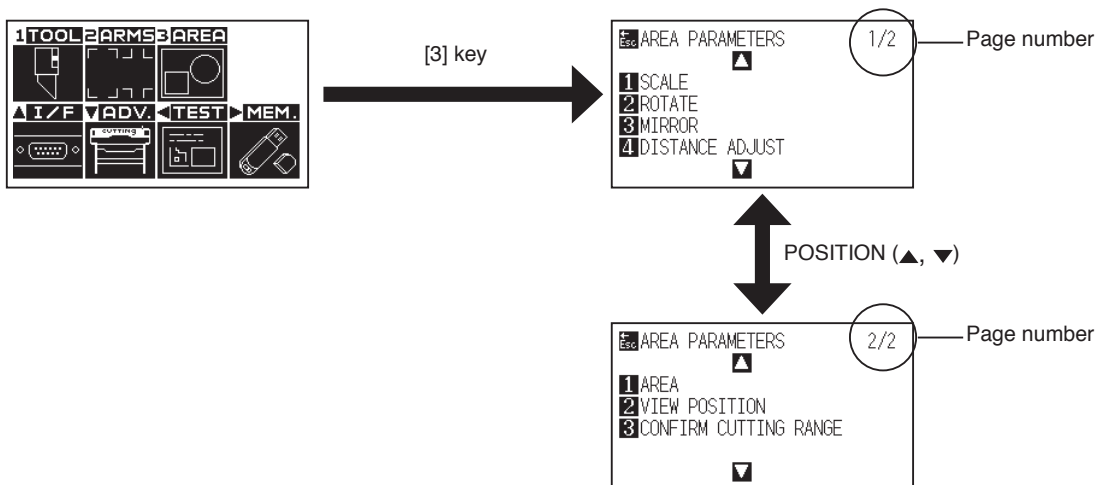

Example of moving page and operation button

Icon of the corresponding operation button is displayed in the screen to change the setting values.

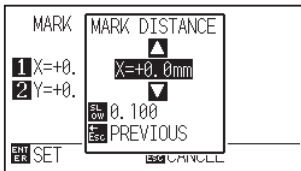

Increase or decrease the setting value using POSITION (\blacktriangle / \blacktriangledown) key. Select the change unit by [FAST] key.

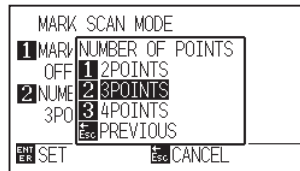

Select the setting by number keys (1, 2, 3, 4) or POSITION (\blacktriangle , \blacktriangledown , \blacktriangleleft , \blacktriangleright) keys.

Example of screen to change the settings value

Contents of Operation from Menu Screen

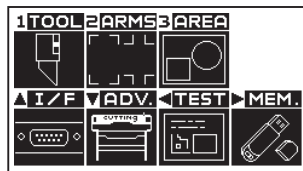

Menu screen

Contents of the operation and settings that is displayed in MENU screen with [PAUSE/MENU] key is as following:

- [1] (TOOL) : Sets the setting for the operation of the tool.
- [2] (ARMS) : Sets the settings and operation to position the tool and media, such as automatic scanning of the registration marks by the ARMS.
- [3] (AREA) : Sets the settings for area, magnification, rotate, mirror, etc., of the cutting.
- [\blacktriangle] (I/F) : Sets the settings of the condition for the interfacing with the control computer.
- [\blacktriangledown] (ADV) : Sets the settings of the conditions for the basic operation of the plotter, such as display language, unit of the measurements.
- [\blacktriangleleft] (TEST) : Performs the operation necessary for maintenance, such as self diagnostic test or printout of the condition settings list.
- [\blacktriangleright] (MEM.) : Performs the operation necessary for the output such as off-line output.
- [PAUSE/MENU] : It will close the MENU screen and return to default screen.
- [SLOW] : Displays the position key screen. When media is set, the tool position can be moved.

See the "Menu Tree" for list of the descriptions about each settings.

Contents of Operation from [COND/TEST] Key

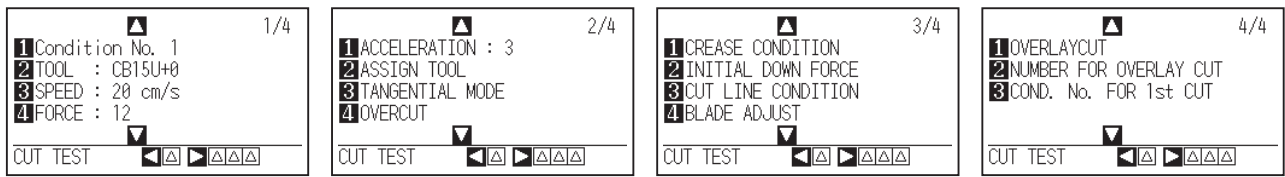

CONDITION screen (1-4):

The [COND/TEST] key brings up the SETTING screens, where you can change the tool conditions.

[COND/TEST]: This will clear the CONDITION screen and return to default screen.

See "2.8 Selecting Tool Condition" for the detailed tool condition.

2.5 Loading the Media

Supplement

- This plotter is available with a vacuum suction writing panel, an electrostatic writing panel, or a magnetic writing panel. Note that the media is loaded differently depending on the media hold-down method.
- There are media that cannot be held down by any method. Please test before use.
- Antistatic-treated media cannot be held down in electrostatic writing panel.
- If air gets in between the writing panel and the media during loading, force out the air and ensure that the media is securely attached to the writing panel before cutting.
- When cutting a media that doesn't come with a backing sheet on the electrostatic writing panel/magnetic writing panel, spread a vinyl backing sheet or something similar on the panel before cutting. Replacement of damaged writing panel is available for a fee.
- When loading a media that cannot be securely attached using the normal hold-down method, reinforce adhesion by using tape on all four sides.
- Common spray glue is often used for this purpose. However, since the spray glue remover contains an anti-static agent, do not use it directly on the writing panel of models which feature electrostatic media hold-down.
- When the media is changed to a different type, we recommend that you perform the registration mark sensor sensitivity adjustment. (Refer to "Setting the Registration Mark Detection Judgment Level" section in Chapter 4.)

Vacuum suction

- (1) Place the media on the writing panel.
- (2) Turn on the vacuum pump's power supply.

Supplement

The vacuum pump is not supplied as a standard accessory. It must be purchased separately.
Refer to CHAPTER 7 VACUUM SUCTION for pump selection and connection instructions.

Electrostatic adhesion

- (1) Make sure that the [CHART HOLD] key is turned off.
- (2) Place the media on the writing panel.
- (3) Press the [CHART HOLD] key (to hold-down the media) next to the control panel.
- (4) The green [CHART HOLD] key lamp (to hold-down the media) lights to indicate that the media is being held by electrostatic adhesion.

Supplement

Press the [CHART HOLD] key again to release the electrostatic adhesion. The green lamp will no longer be lit.
It may take some time to be able to hold-down the media by pressing the [CHART HOLD] key depending on operating environment.
After the media has been held for a while by electrostatic adhesion, it may become charged with static electricity and therefore be harder to remove from the writing panel. There is nothing abnormal about this phenomenon.

Magnetic

- (1) Place the media on the writing panel.
- (2) Secure the edges of the media with the sheet holder plates which are supplied with your plotter as standard accessories.

2.6 Connecting to the Power

This section describes how to turn on the power of this plotter.

Operation

- 1 Check that the power switch is turned off. ("O" side)

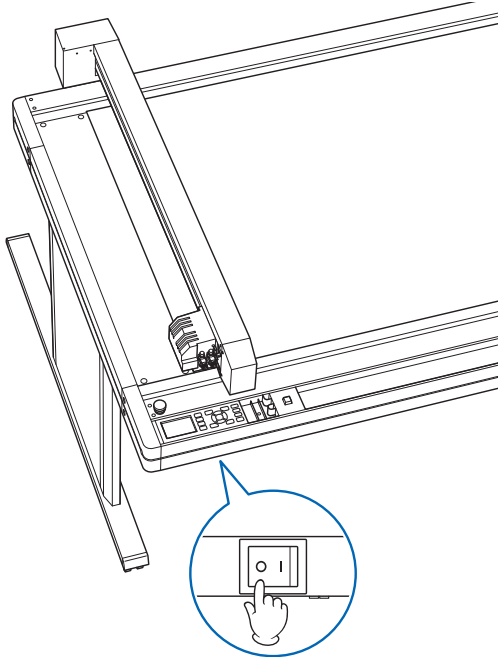

- 2 Connect one end of the provided power cord to the FCX2000 AC line inlet and the other end to an electrical socket of the rated supply voltage.

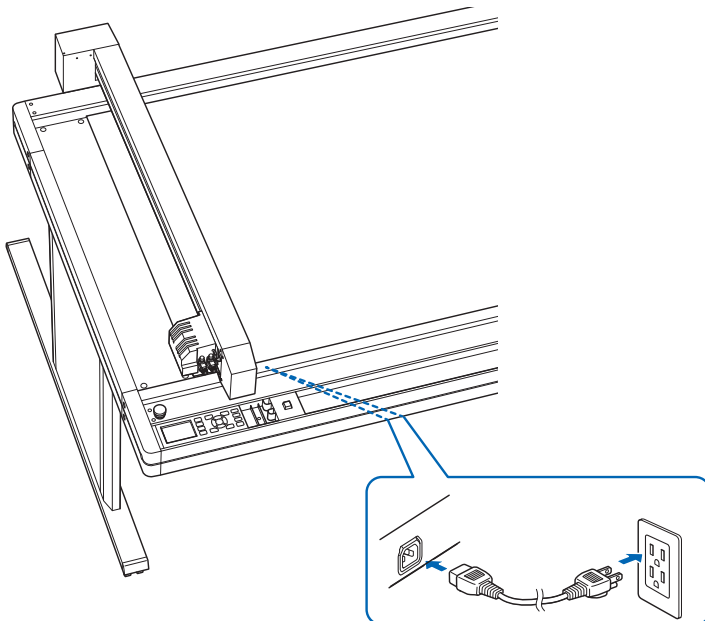

- 3 Turn on the FCX2000 ("I" side).
LCD on the control panel is lit and it becomes READY status.

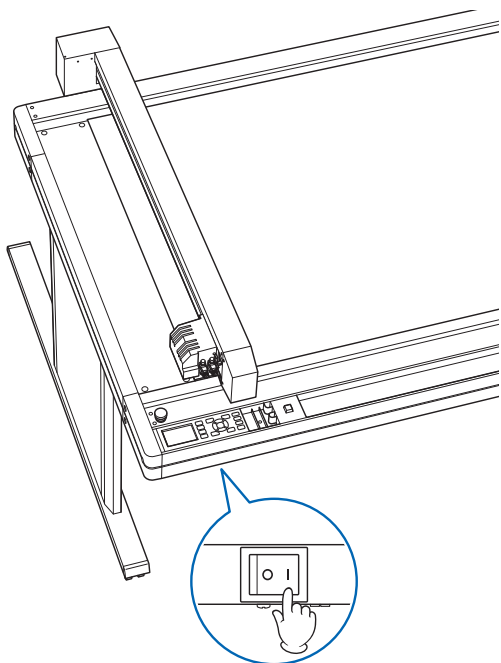

Supplement

When turning off the power, wait over 10 seconds before turning on it again, otherwise problems may occur with the display.

2.7 About the Initial Setup Screen

The Initial Setup Screen appears only when powering up the machine for the first time after purchase. Here, you can set the display language and length unit.

You can also enter the menu select from the READY status after a setup.

(Refer to “Display Language Settings (Language)” and “Display Length Unit Settings (Length Unit)” in Chapter 10.)

See "2.6 Connecting to the Power" for turning on the power.

Operation

- 1 Once the machine is powered on ("I" side) a message will be displayed after the version is displayed.



Supplement

DISPLAY LANGUAGE setting screen is displayed.

- 2 Use the POSITION (▲▼◀▶) keys to select the language.
(This manual assumes you chose the English language setting.)

- 3 Press the [ENTER] key.
After the DISPLAY LANGUAGE is selected, the LENGTH UNIT screen will appear.

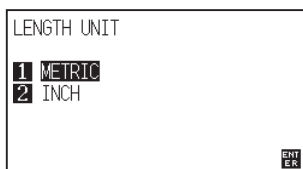

- 4 Press the [1] key (METRIC) or the [2] key (INCH) to select the length unit setting.
- 5 Confirm the setting and press the [ENTER] key (SET).
Setting will be set, and it will return to default screen.

2.8 Selecting Tool Condition

Set the “TOOL CONDITION (Cut Condition) No.”, “TOOL”, “OFFSET”, “FORCE”, “SPEED”, and “ACCEL (ACCELERATION)”.

LCD Display

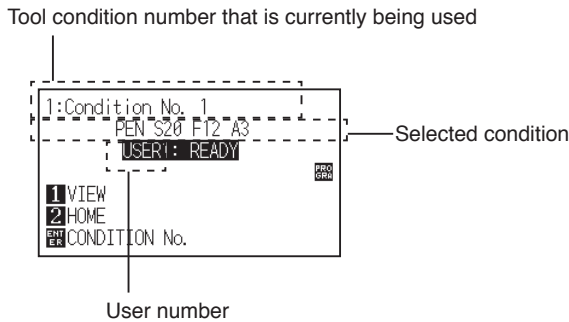

Selecting the tool condition number

Eight settings (1 to 8) as the tool condition can be stored. By switching this setting, it can be switched to 8 types of label material-specific settings that have been set previously.

Operation Method: Operation with the [COND/TEST] key

- 1 Press the [COND/TEST] key from READY status.

▶ CONDITION setting screen (1/4) is displayed.

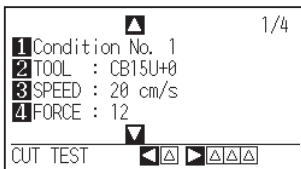

- 2 Press the [1] key.

▶ CONDITION No. selection screen is displayed.

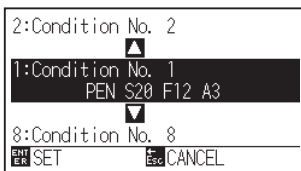

- 3 Press the POSITION (▲▼) keys and select the setting.

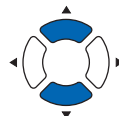

- 4 Confirm the setting and press the [ENTER] key.
 - ▶ Setting will be set, and it will return to CONDITION screen (1/4).

- 5 Press the [COND/TEST] key.
 - ▶ It will return to default screen.

Supplement

Press the [ESC] before pressing the [ENTER] key to return to the default screen without changing any settings.

Operation Method: Operation with the [ENTER] key

- 1 Press the [ENTER] key from READY status.
 - ▶ CONDITION No. selection screen is displayed.

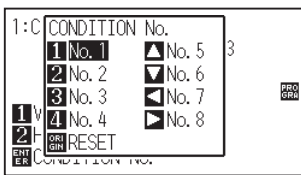

- 2 Select the CUT CONDITION (Tool Condition) by pressing one of [1] to [4] key or using the POSITION (▲▼◀▶) keys while holding down the [ENTER] key. (The selected item is highlighted.)

- 3 Confirm the setting and release the [ENTER] key.
 - ▶ It will return to default screen.

Setting the Tool Condition

This section describes how to make the tool, speed, force, acceleration, and tool number settings.

Before cutting media, the following four cutter pen conditions must be specified.

- OFFSET
- SPEED
- FORCE
- ACCELERATION



CAUTION

- It may result to damaging the cutter blade or the writing panel if the blade is extended too much. Make sure the blade length is set less than the thickness of the media.

Tool Conditions (Cutter Blade) for Each Media Type

Refer to the Cutter Blade Manual.

Blade Part Nos., Displayed Blade Types, and CUTTER OFFSET values

Refer to the Cutter Blade Manual.

Supplement

- Finish quality will become coarser, but the cut time is decreased when the settings for the speed and acceleration is set higher. Especially, good cut quality might not be achieved because the media state becomes unstable during operation. Decrease the values for the speed and acceleration in that case.
- Finish quality will become good, but the cut time will increase when the settings for the speed and acceleration is set smaller.

Setting the Tool

Set the tool type and offset to be used.

Set their values in accordance with tool condition of each label material and each tool type. (Refer to “Tool condition for each tool” described above).

Operation

- 1 Press the [COND/TEST] key in the default screen.

▶ CONDITION setting screen (1/4) is displayed.

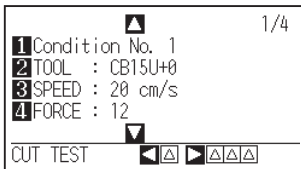

- 2 Press the [2] key (TOOL).

▶ TOOL setting screen is displayed.

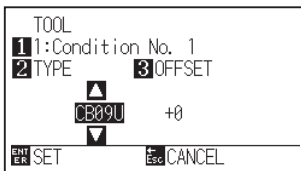

- 3 Press the POSITION (▲▼) keys, and set the tool.

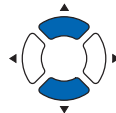
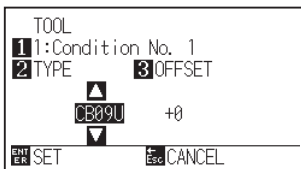

- 4 Press the [3] key (OFFSET).

▶ OFFSET setting screen is displayed.

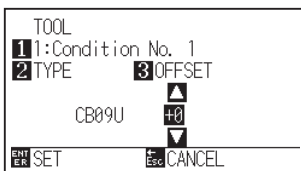

- 5 Press the POSITION (▲▼) keys and increase or decrease the setting value.

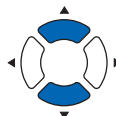

- 6 Confirm the setting and press the [ENTER] key (SET).

▶ Setting will be set, and it will return to CONDITION screen (1/4).

- 7 Press the [COND/TEST] key.

▶ It will return to default screen.

Supplement

- What is Offset

It will adjust the difference between the tip of the blade in the plunger and the center of the plunger. There are standard adjustment values for each cutter blades. Fine adjustment will be made to that standard values here. (Adjustment will be made with standard value as 0.)

- Setting range is from -5 to +5

In the case of other setting range, it is +1 to +99.

Supplement

Press the [ESC] key (Return) to return to the CONDITION screen without changing any settings.

Setting the Creasing Mode

When selecting the creasing tool, you can set the spacing, the number of creasing operations and the start and end positions.

Creasing mode is enabled only when the tool type is set to the creasing tool (CP001, CP002, CP003, CT-002).

Operation

- 1 Press the [COND/TEST] key in the default screen.

▶ CONDITION setting screen (1/4) is displayed.

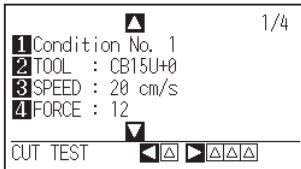

- 2 Press POSITION (▲) key twice.

▶ CONDITION setting screen (3/4) is displayed.

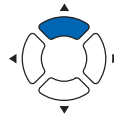
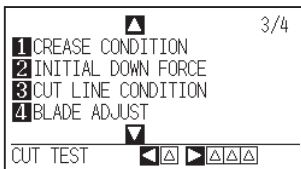

- 3 Press the [1] key (CREASE CONDITION).

▶ CREASE CONDITION setting screen is displayed.

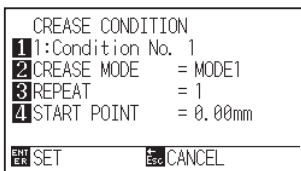

Supplement

Press the [ESC] key (Return) to return to the CONDITION screen without changing any settings.

<Setting the Creasing Mode>

Modes 2 and 3 enable thick media to be bent easily.
Selectable parameters: MODE 1. MODE 2, MODE 3

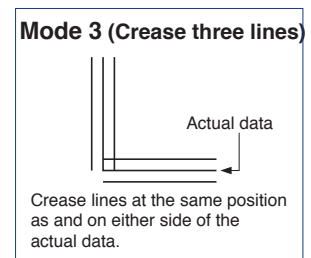
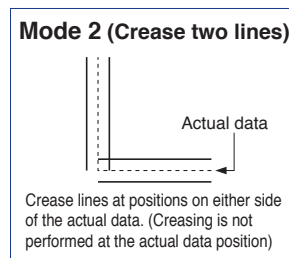
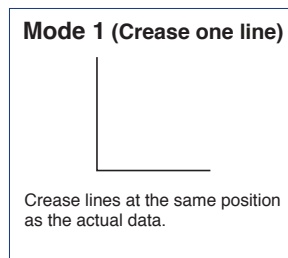
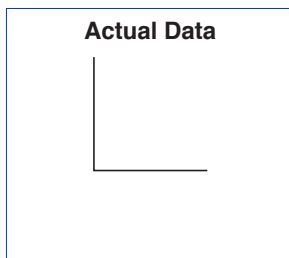

- 4 Press the [2] key (CREASE MODE).

▶ CREASE MODE setting screen is displayed.

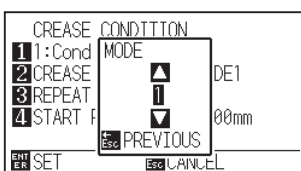

- 5 Select the mode using the POSITION (▲▼) keys and press [ESC] key.

▶ CREASE setting screen is displayed.

<Setting of Spacing>

Set the spacing between the lines.

Setting range: 0 to 9.99 (mm)



- 6 Press [▼] key (SPACING)

▶ SPACING setting screen is displayed.

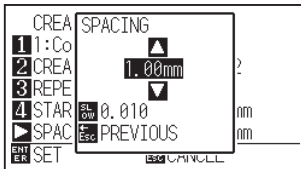

Supplement

The spacing parameter is only enabled for Modes 2 and 3.

- 7 Increase or decrease the setting value using the POSITION (▲▼) keys and press the [ESC] key.

▶ CREASE setting screen is displayed.

<Setting the number of creasing operations>

This setting determines how many times creasing should be repeated for each line segment.

Setting range: 1 to 9 (times)

- 8 Press the [3] key (REPEAT).

▶ SPACING setting screen is displayed.

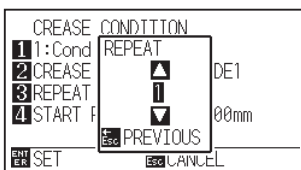

- 9 Increase or decrease the setting value using the POSITION (▲▼) keys and press the [ESC] key.

▶ CREASE setting screen is displayed.

<Setting the Start and End Positions>

This setting determines by what margin each end of the creasing line falls short of the corresponding end of the actual data line.

Setting range: 0 to 9.99 (mm)

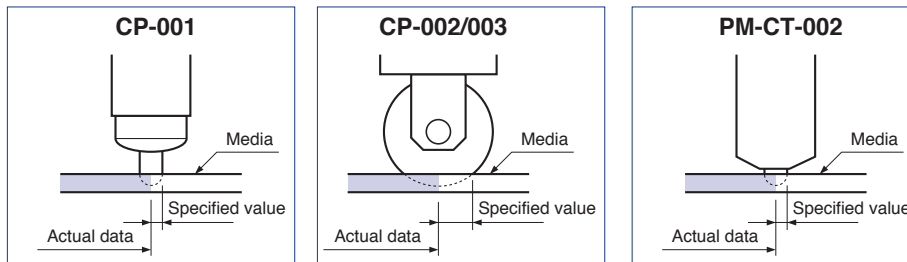

10 Press the [4] key (START).

▶ START setting screen is displayed.

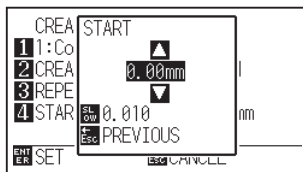

Supplement

For short-line data such as circle command data, setting a large value for the START parameter (Start position) may result in cutting/plotting not being performed.

11 Increase or decrease the setting value using the POSITION (▲▼) keys and press the [ESC] key.

▶ CREASE setting screen is displayed.

12 Confirm the setting and press the [ENTER] key (SET).

▶ Setting will be set, and it will return to CONDITION screen (3/4).

13 Press the [COND/TEST] key.

▶ It will return to default screen.

Setting the Speed

Set the speed of the tool that is used in each of the condition numbers.
 Setting range : 1 to 10 (in 1 cm/s increment), 10 to 40 (in 5 cm/s increment)

Operation

- 1 Press the [COND/TEST] key in the default screen.

▶ CONDITION setting screen (1/4) is displayed.

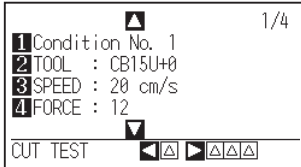

- 2 Press the [3] key (SPEED) .

▶ SPEED setting screen is displayed.

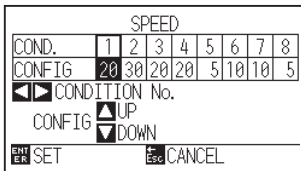

* Display may vary depending on the selected tool condition number.

- 3 Press the POSITION (◀▶) keys and select the tool condition number (CONDITION No.) .

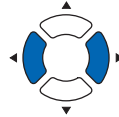

- 4 Press the POSITION (▲▼) keys and increase or decrease the setting value.

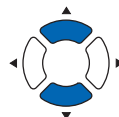

- 5 Confirm the setting and press the [ENTER] key (SET).

▶ Setting will be set, and it will return to CONDITION screen (1/4).

- 6 Press the [COND/TEST] key.

▶ It will return to default screen.

Supplement

You can set 1 to 10 (1-step) or 15 to 40 (5-step) (cm/s).

Setting the Force

Set the cutting force that is used in each of the condition numbers.

Setting range : Depends on the selected tool number.

Operation

- 1 Press the [COND/TEST] key in the default screen.

▶ CONDITION setting screen (1/4) is displayed.

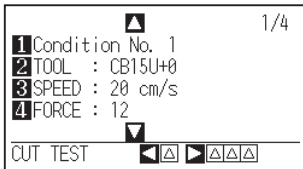

- 2 Press the [4] key (FORCE).

▶ FORCE setting screen is displayed.

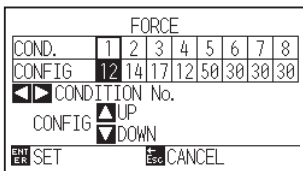

* Display may vary depending on the selected tool condition number.

- 3 Press the POSITION (◀▶) keys and select the condition number (CONDITION No.).

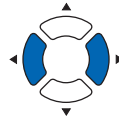

- 4 Press the POSITION (▲▼) keys and increase or decrease the setting value.

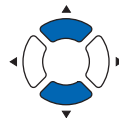

- 5 Confirm the setting and press the [ENTER] key (SET).

▶ Setting will be set, and it will return to CONDITION screen (1/4).

- 6 Press the [COND/TEST] key.

▶ It will return to default screen.

Supplement

When "XY FORCE SWITCH" is enabled, the following screen is displayed.

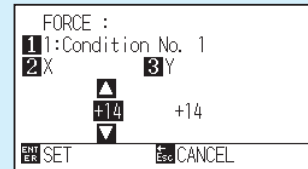

Using the [2] and [3] keys, move X and Y. Then, press the POSITION (▲▼) keys and increase or decrease the set value.

If different values have been set for X and Y, the cutting force in the diagonal direction will be an intermediate value of X and Y values, and will vary according to the angle.

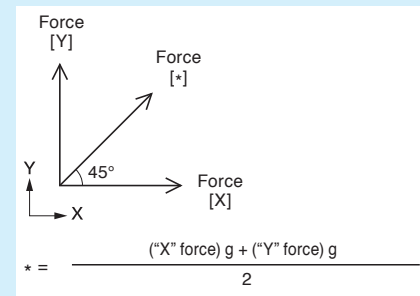

Supplement

Settable range depends on the selected tool number.

For the Tool 1, you can set to 1 to 40 (1-step).
For the Tool 2, you can set to 2 to 80 (2-step).

Setting the Acceleration

Set the acceleration of the tool that is used in each of the tool condition numbers.

Setting range : 1 to 6

Operation

- 1 Press the [COND/TEST] key in the default screen.

▶ CONDITION setting screen (1/4) is displayed.

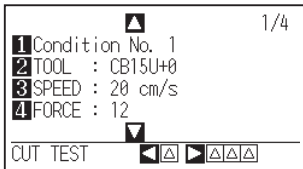

- 2 Press the POSITION (▲) key.

▶ CONDITION setting screen (2/4) is displayed.

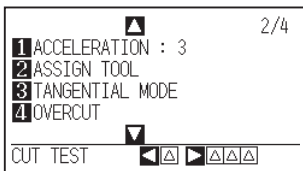

- 3 Press the [1] key (ACCELERATION).

▶ ACCEL setting screen is displayed.

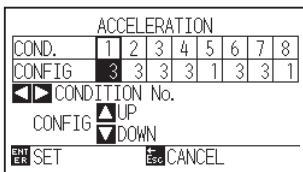

* Display may vary depending on the selected tool condition number.

- 4 Press the POSITION (◀▶) keys and select the condition number (CONDITION No.).

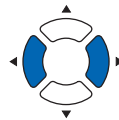

- 5 Press the POSITION (▲▼) keys and increase or decrease the setting value.

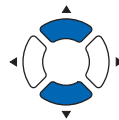

Supplement

You can set between 1 and 6.

When the value is reduced, the acceleration is lower and the quality is better.

- 6 Confirm the setting and press the [ENTER] key (SET).

▶ Setting will be set, and it will return to CONDITION screen (2/4).

- 7 Press the [COND/TEST] key.

▶ It will return to default screen.

Adjust the Blade Length

Optimal cut is not achieved unless the blade length is adjusted in accordance with the used label material and the cutter blade. Perform further adjustment by performing cutting test after adjusting the blade length manually.

CAUTION

- To avoid bodily injury, handle cutter blades with care.
- It may result in damaging the cutter blade or the writing panel if the blade is extended too much.

Supplement

For the test cut, please refer to the "Running Cutting Tests" below.

Please use the supplied magnifier to adjust the blade length. For information on how to use the magnifier, please refer to the instruction manual for the magnifier.

Operation

- 1 Align the blade tip to the tip of the cutter pen, and make it touch the surface of the media.

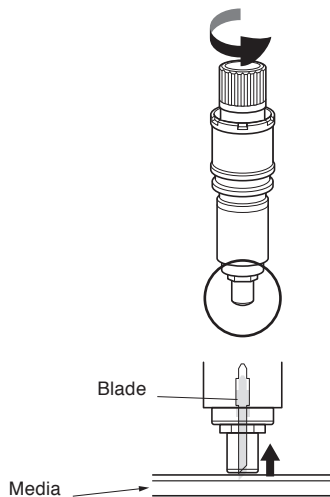

- 2 Extend the blade little by little to the thickness of the media. Optimal blade length is less than the thickness of film and backing sheet combined, but more than the thickness of the film.

Try cutting the film, and adjust so there is slight cutting on the backing sheet. If the backing sheet gets cut completely, reduce the blade length, and if the film does not get cut completely, increase the blade length.

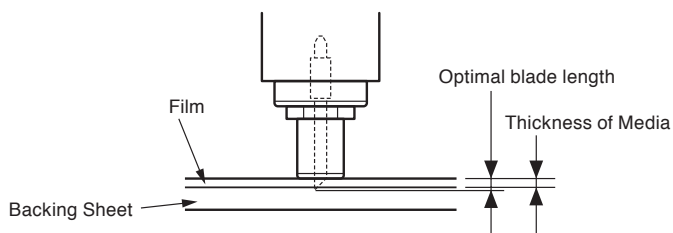

Supplement

- In the case of PHP35-CB09-HS/PHP35-CB15-HS

Blade length can be changed by spinning the adjuster on the blade. Spinning it in the A direction pushes it out, while spinning it in the B direction pulls it in. One scale unit is equal to 0.1 mm.

Cutter blade moves approximately 0.1 mm turning one scale unit.

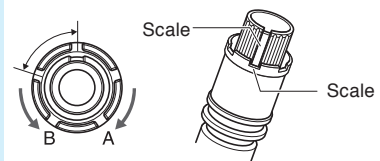

- **Guideline to Set the Blade Length**
See "Setting the Tool Condition" for the thickness of the media.

2.9 Running Cutting Tests

Test cutting can be performed after making the tool, speed, force, and acceleration settings to ensure that the selected cutting conditions actually produce the desired cutting results. Check how far the blade cuts into the media and how the corners are being cut. If the cutting results are not satisfactory, adjust the various settings and repeat the test cutting until the optimal settings are achieved.

Cutting Test

You can either cut one test pattern based on the current values, or do three tests with ± 1 values added. Select the method depending on the situation.

To make 1 cut with set value

Operation

- 1 Load the media for test cutting in the plotter.
- 2 Press the [COND/TEST] key in the default screen.
▶ CONDITION setting screen (1/4) is displayed.

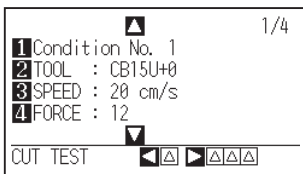

- 3 Press the POSITION (◀) key (CUT TEST).

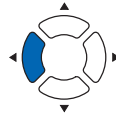
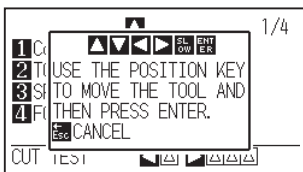

Supplement

It will return to **CONDITION** screen by pressing the [ESC] key (CANCEL).

- 4 Press the POSITION (▲▼◀▶) keys to move the tool carriage to the location you wish to perform the test cutting.

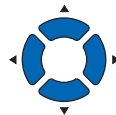

Supplement

Pushing simultaneously the [POSITION] and [SLOW] keys moves the tool carriage slowly.

- 5 Press the [ENTER] key.
▶ 1 cut test pattern is cut.

CAUTION

When the [ENTER] key is pressed, the tool carriage will start moving, so take care not to cut your fingers.

- 6 Press the [ESC] key after completion.
▶ CUT TEST screen is displayed.
- 7 Press the [COND/TEST] key.
▶ It will return to default screen.

To make 3 cuts with set value and ± 1 of set value

Operation

- 1 Load the media for test cutting in the plotter.
- 2 Press the [COND/TEST] key in the default screen.
▶ CONDITION setting screen (1/4) is displayed.

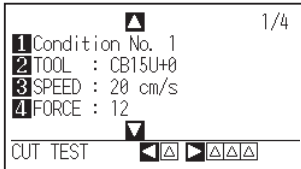

- 3 Press the POSITION (▶) key (CUT TEST).

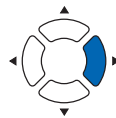
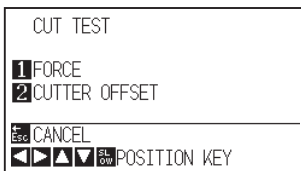

Supplement

It will return to CONDITION screen by pressing the [ESC] key (CANCEL).

- 4 Press the POSITION (▲▼◀▶) keys to move tool carriage to the location you wish to perform the test cutting.

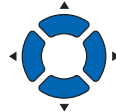

Supplement

Pushing simultaneously the [POSITION] and [SLOW] keys moves the tool carriage slowly.

- 5 Press the [1] key (FORCE).

▶ 3 cutting test patterns are cut, with current FORCE in the center, and 1 each of FORCE increased and decreased for 1.

CAUTION

When the [1] key (FORCE) is pressed, the tool carriage will start moving, so take care not to cut your fingers.

Supplement

Test cut patterns can have their cut order and force changed as shown below.

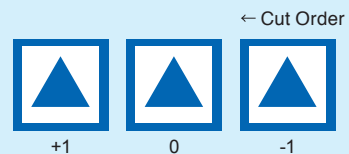

- 6 Press the [ENTER] key after completion.

▶ It will return to CUT TEST menu screen.

- 7 Press the [2] key (CUTTER OFFSET).

▶ 3 cutting test patterns are cut, with current CUTTER OFFSET in the center, and 1 each of CUTTER OFFSET increased and decreased for 1.

Supplement

When the [2] key (CUTTER OFFSET) is pressed, the tool carriage will start moving, so take care not to cut your fingers.

8 Press the [ENTER] key after completion.

▶ It will return to CUT TEST menu screen.

9 Press the [COND/TEST] key.

▶ It will return to default screen.

Confirm the Results of the Cutting Test

Confirm the cutting test results, and adjust to optimal setting. Repeat cutting test and adjustment until optimal cut is achieved.

Adjustment of Offset

Check the corners of the triangles and rectangles. See "Setting the Tool Condition" and adjust the offset value if the corner is not cut or if it is cut too much.

Supplement

How to check offset

Check if the offset value is set correctly by following.

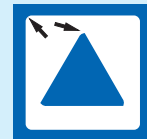

Not enough adjustment.
Increase the offset value.



Optimal offset value.

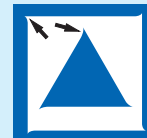

Too much adjustment.
Decrease the offset value.

Adjustment for Half Cutting

Peel off the triangle area, and adjust so it cuts slightly into the backing sheet.

If the backing sheet has been cut through, either the FORCE setting is too high or the cutter-blade tip is extended too far. If the backing sheet shows only a few traces of the cutter blade, either the FORCE setting is too low or the cutter blade tip is not sufficiently extended.

Supplement

See "Adjusting the Blade Length" and "Setting the Force" and adjust the settings.

Adjustment for Cutting Out

Adjust so the media is completely cut out.

If the media is not completely cut, either the FORCE setting is too low or the cutter blade tip is not sufficiently extended.

See "Adjusting the Blade Length" and "Setting the Force" and adjust the settings.

Adjustment When Using Plotting Pen

Adjust the FORCE so there will be no faint lines. To prolong the pen life, set the FORCE to the lowest setting without any faint lines. See "Setting the Force" or setting the FORCE.

Adjust the Blade Length (Automatic Height Adjust)

Test cutting must be performed several times in order to confirm the optimal blade length setting. However, if the blade length adjustment function is used, the optimal length can be easily set.

Supplement

- In the case of the less than 1 mm adjustment , please use the supplied magnifier.
- The measured height is a guideline only. After attempting to cut the actual media, please adjust blade length accurately.

Operation

- 1 Load the media for test cutting in the plotter.
- 2 Press the POSITION (▲▼◀▶) keys to move the tool carriage to the location you wish to perform the blade length adjustment.

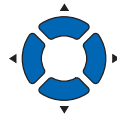

- 3 Press the [COND/TEST] key in the default screen.

▶ CONDITION setting screen (1/4) is displayed.

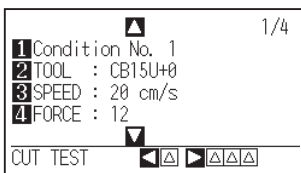

- 4 Press the POSITION (▲) key twice.

▶ CONDITION setting screen (3/4) is displayed.

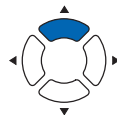
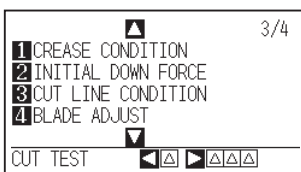

- 5 Press the [4] key (BLADE ADJUST).

▶ Message prompting to turn the blade length adjustment knob is displayed.

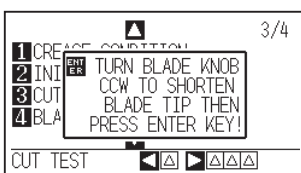

Supplement

It will return to **CONDITION** screen by pressing the [ESC] key (CANCEL).

- 6 As instructed, turn the blade length adjustment knob to the left to fully retract the blade.

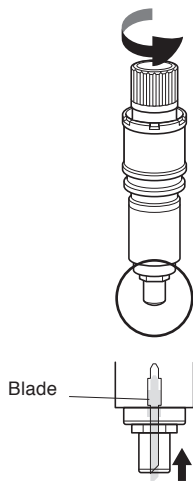

Supplement

See "Structure of Cutter Plunger" for blade length adjustment knob.

- 7 Set the cutter pen in Tool Holder.

Supplement

See "Attaching a Tool" for instructions on setting.

- 8 Press the [ENTER] key.
You can calculate the height by moving the tool up and down.

▶ TO ACHIEVE THE TARGET LENGTH screen is displayed.

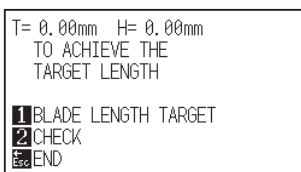

- 9 Press the [1] key (BLADE LENGTH TARGET).

▶ BLADE LENGTH TARGET screen (TARGET) is displayed.

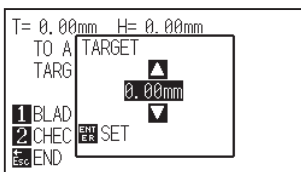

- 10 Press the POSITION (▲▼) keys and increase or decrease the setting value.

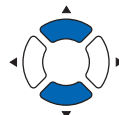

- 11 Confirm the settings and press the [ENTER] key.

▶ The Blade Length Target will be selected, and you will return to the TO ACHIEVE THE TARGET LENGTH screen.

12 Press the [2] key (CHECK).

You can calculate the height by moving the tool up and down.

▶ The amount and direction to turn the adjustment knob is displayed.

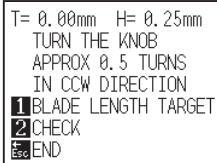

T= 0.00mm H= 0.25mm
TURN THE KNOB
APPROX 0.5 TURNS
IN CCW DIRECTION
1 BLADE LENGTH TARGET
2 CHECK
END

Supplement

"T" is the target value of the blade length, and "H" is the current blade height (amount).

Turning the blade length adjustment knob displays the number of turns and direction.

13 Turn the blade length adjustment knob and adjust the cutter blade length.

Current blade length is displayed by pressing the [2] key (CHECK), so adjust the blade length until it matches the thickness of the media.

Supplement

Depending on the loaded media, the blade might sink in to the media, making accurate measurement impossible.

14 Press the [ESC] key (END).

▶ Adjustment is completed and it will return to CONDITION screen.

15 Press the [COND/TEST] key.

▶ It will return to default screen.

2.10 Display Cutting Area

You can check the width and height of cutting area.

Operation

- 1 Press the [SLOW] key in the default screen.

▶ The cutting area is displayed.

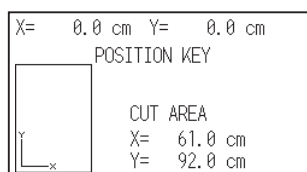

- 2 Release the [SLOW] key.

▶ It will return to default screen.

Chapter 3: Basic Operations

This chapter describes the basic methods to operate the plotter manually.

All the operations described in this chapter is to start from the READY status (media is set) as a general condition.

Perform the operation described in this chapter after making the plotter in READY status referring to previous chapter.

PRODUCT SUMMARY

- 3.1 *Raise or Lower the Tool***
- 3.2 *Move the Tool Carriage***
- 3.3 *Setting the Origin Point***
- 3.4 *Setting the Cutting Direction***
- 3.5 *Stop Cutting***

3.1 Raise or Lower the Tool

This is a function to raise or lower the tool (pen).

Operation

- 1 Press the [PAUSE/MENU] key.

▶ MENU screen is displayed.



- 2 Press the [1] key (TOOL).

▶ TOOL SETTING (1/4) screen is displayed.

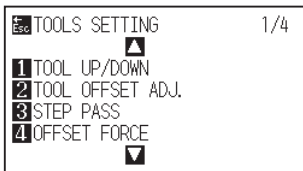

- 3 Tool is raised or lowered every time the [1] key (TOOL UP/DOWN) is pressed.

- 4 Press the [PAUSE/MENU] key.

▶ It will return to the default screen.

3.2 Move the Tool Carriage

Tool carriage can be moved manually using the POSITION key.

It also can move the tool carriage to the origin, or move it certain distance to keep it away.

Move in Steps Manually

It can manually move in steps when the screen is displaying "READY", or when the POSITION (▲▼◀▶) keys is displayed.

Operation

- 1 Press the POSITION (▲▼◀▶) keys once to move in the desired direction.

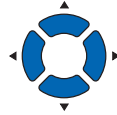

- ▶ Tool carriage will move toward the direction of the pressed POSITION key for 1 step.

Supplement

- It will move in steps every time POSITION (▲▼◀▶) keys is pressed.
- Distance of step movement can be changed. See "Setting of Step Movement Distance".

Continuously Move Manually

It can manually move continuously when the screen is displaying "READY", or when the POSITION (▲▼◀▶) keys is displayed.

Operation

- 1 Hold the POSITION (▲▼◀▶) keys down to keep moving in the desired direction.

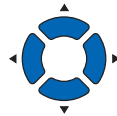

- ▶ Tool carriage keeps on moving toward the direction of the pressed POSITION key.

- 2 Release the POSITION (▲▼◀▶) keys.

- ▶ Movement of the tool carriage stops.

Supplement

When pressing the [SLOW] key and the POSITION key at the same time, the tool carriage moves slowly.

Setting of Step Movement Distance

The parameters when setting the cutting direction are determined by the distance of the cutting direction.

Operation

- 1 Press the [PAUSE/MENU] key.

▶ MENU screen is displayed.



- 2 Press the POSITION (▼) key (ADV).

▶ ADV. setting screen (1/3) is displayed.

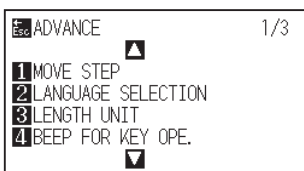

- 3 Press the [1] key (MOVE STEP).

▶ MOVE STEP screen is displayed.

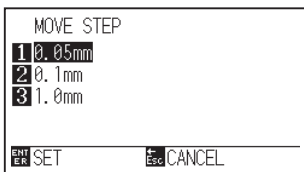

- 4 Press the [1] key (0.05 mm), [2] key (0.1 mm) or [3] key (1.0 mm).

Supplement

Settable value is 0.05, 0.1, 1.0 (mm).

Value chosen here will be the movement distance for the step movement.

- 5 Confirm the setting and press the [ENTER] key (SET).

▶ Setting will be set, and it will return to the ADV. setting screen (1/3).

Supplement

It will return to the default screen setting screen (1/3) without changing the settings when you press the ESC key (CANCEL).

- 6 Press the [PAUSE/MENU] key.

▶ It will return to the default screen.

Move Away the Tool Carriage

It is possible to move away the tool carriage toward upper right. It makes it easier to confirm the cutting results if you perform this operation after the cutting is completed.

Moving away tool carriage

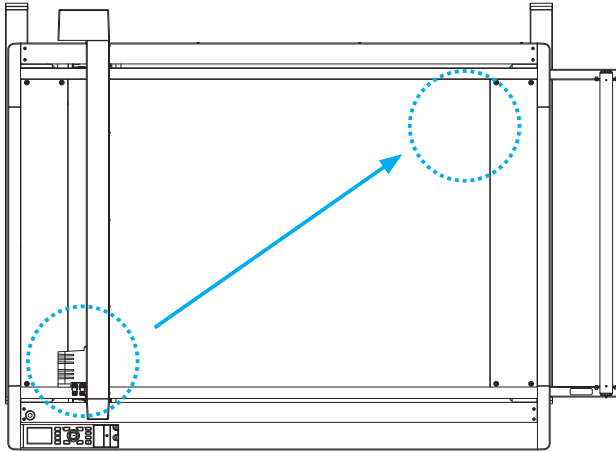

Operation

- 1 Press the [1] key (VIEW) in READY status.
 - ▶ Tool carriage will move away.

To move the tool carriage to the origin point, do following:

Operation

- 1 Press the [2] key (HOME) in READY status.
 - ▶ Tool carriage will move to the origin point.

Change the Cutting Condition (Condition No.)

Go through the following steps to change the Cutting Condition (Condition No.).

Operation

- 1 Press the [ENTER] key in READY status.

▶ CONDITION No. selection screen is displayed.

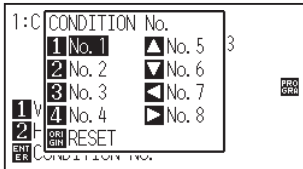

- 2 Press the [1] to [4] key or the POSITION (▲▼◀▶) keys while holding down the [ENTER] key to select the cutting condition. (The item is highlighted.)

- 3 Confirm the setting and release the [ENTER] key.

▶ It will return to the default screen.

Supplement

When the [ORIGIN] key (RESET) is pressed, it will return to state when the power is turned on.

Please refer to for Reset (Revert to the initial state when the power was turned on.).

Reset (Revert to the initial state when the power was turned on.)

To move to the position as after the power was turned on, do following.

Operation

- 1 Press the [ENTER] key in READY status.

▶ CONDITION No. selection screen is displayed.

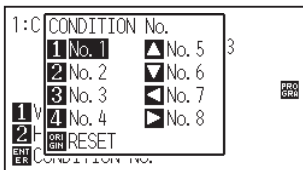

- 2 Press the [ORIGIN] key (RESET).

▶ Perform the initialization operation and then the READY screen is displayed.

3.3 Setting the Origin Point

Point where the cutting starts is called origin point. The origin point can be set at any location.

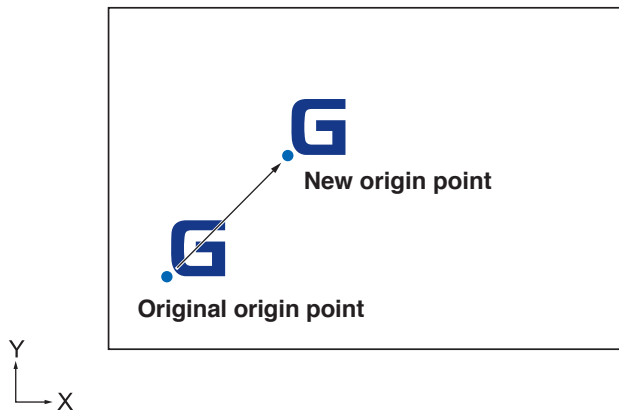

- 1 Press the POSITION (▲▼◀▶) keys to move the tool to the new origin point.

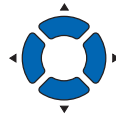

- 2 Press the [ORIGIN] key. The beeper sounds to indicate that the new origin has been set.

▶ New origin point is set, and "NEW ORIGIN POINT IS SET !" is displayed for few seconds in the screen.

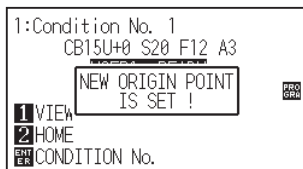

- 3 When the [ORIGIN] key is held down, the beeper sounds. When you remove your finger from the [ORIGIN] key, the beeper sounds again.

▶ The following screen is displayed.

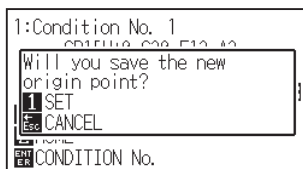

Press the [1] key to set the new origin. Then, the ORIGIN lamp lights.

In this case, even if turned ON/OFF the power, the set origin is not cleared.

▶ "The new origin was recorded" message is displayed on the screen for a few seconds.

[ORIGIN] lamp lights.

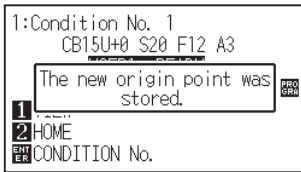

If the ROTATE (the coordinates are rotated) or MIRROR mode is selected or cancelled after the origin point has been moved, the origin point is reset to its default position.

However, if the [ORIGIN] key is held down, the origin point is not reset to its default position even when the ROTATE or MIRROR mode is cancelled.

To reset the newly registered origin point to its default position, move the cutter pen in the direction towards the lower left point until it stops, and then either hold down the [ORIGIN] key or turn on the power while pressing the [ORIGIN] key.

If you intend to use the ORIGIN function in combination with the ROTATE of the coordinates or the MIRROR mode, be sure to set the cutting origin point after setting the ROTATE of the coordinates or MIRROR mode.

Supplement

- The ORIGIN setting becomes invalid when the Registration Mark mode is specified.
- After a new origin has been set, the coordinates being displayed on the LCD represent the distances along the X and Y axes from the new origin.
- Please refer to "Chapter 4 Registration Mark Settings and Detection" for the origin point after the automatic registration mark reading function has been used.

When Coordinate Axes Rotation are Set

If the origin point is moved while the coordinate axes are rotated, the origin point will move as shown below.

Supplement

See "Setting the Cutting Direction" about the rotation of the coordinate axes.

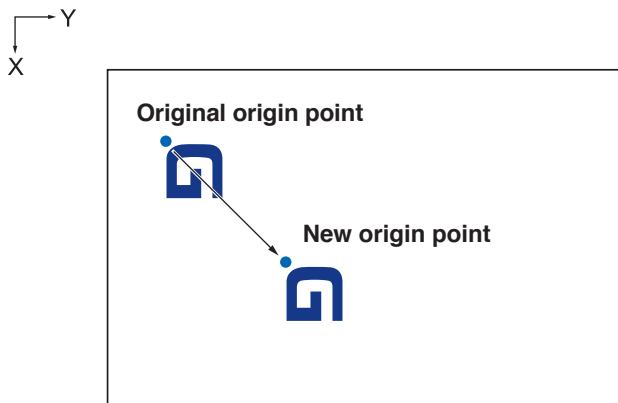

Setting Origin Point When HP-GL is Set

When using the HP-GL command, the origin point is set to either the lower left of the cutting area or the center.

Supplement

- When using the GP-GL command, this setting does not affect the operation.
- See "Settings of Controls from Computer" about setting the COMMAND.

Operation

- 1 Press the [PAUSE/MENU] key.

▶ MENU screen is displayed.



- 2 Press the POSITION (▲) key (I/F).

▶ INTERFACE screen (1/3) is displayed.

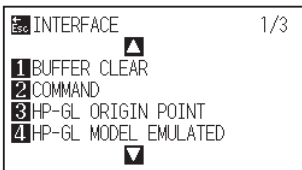

- 3 Press the [3] key (HP-GL ORIGIN POINT).

▶ HP-GL ORIGIN POINT setting screen is displayed.

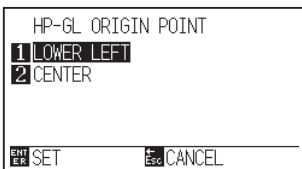

- 4 Press the [1] key (LOWER LEFT) or the [2] key (CENTER).

- 5 Confirm the setting and press the [ENTER] key.

▶ Setting will be set, and it will return to INTERFACE screen (1/3).

- 6 Press the [PAUSE/MENU] key.

▶ It will return to the default screen.

Supplement

It will return to INTERFACE screen (1/3) without changing the settings when you press the [ESC] key (CANCEL).

3.4 Setting the Cutting Direction

Rotate the coordinate axes to change the cutting direction.

Supplement

The rotation settings will be saved even if the power is shut off.

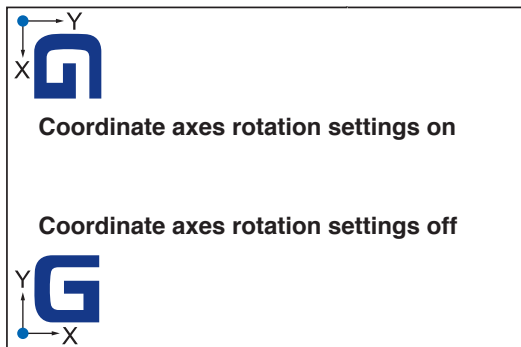

Operation

- 1 Press the [PAUSE/MENU] key.

▶ MENU screen is displayed.

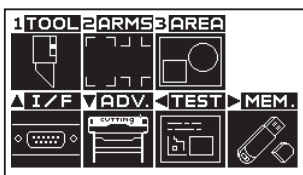

- 2 Press the [3] key (AREA).

▶ AREA PARAMETERS setting screen (1/2) is displayed.

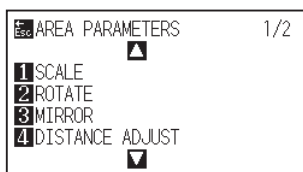

- 3 Press the [2] key (ROTATE).

▶ ROTATE screen is displayed.

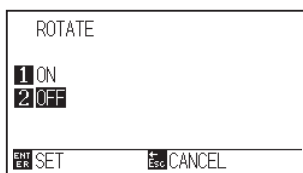

- 4 Press the [1] key (ON) or the [2] key (OFF).

- 5 Confirm the setting and press the [ENTER] key.
 - ▶ Setting will be set, and it will return to AREA PARAMETERS screen (1/2).

- 6 Press the [PAUSE/MENU] key.
 - ▶ It will return to the default screen.

Supplement

It will return to AREA PARAMETERS setting screen (1/2) without changing the settings when you press the (ESC) key (CANCEL).

3.5 Stop Cutting

It will stop cutting when the [PAUSE/MENU] key is pressed while cutting. Operation selection menu is displayed on the screen of the control panel while it is stopped. It is possible to choose either to continue or stop the operation. It is also possible to exchange or reset the media while it is stopped.

Pause and Resume Cutting

Operation

- 1 Press the [PAUSE/MENU] key.
▶ Cutting will stop and following screen is displayed.

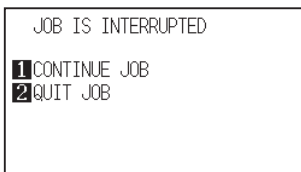

- 2 Perform necessary operation, such as exchanging the media.

- 3 Press the [1] key (CONTINUE JOB).
▶ Cutting will start and the screen will resume to operation.

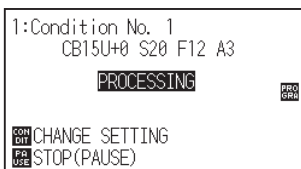

Supplement

It will stop cutting by pressing [2] key (QUIT JOB).

See "Stop Cutting".

Stop Cutting

Operation

1 Press the [PAUSE/MENU] key.

▶ Operation will stop and following screen is displayed.

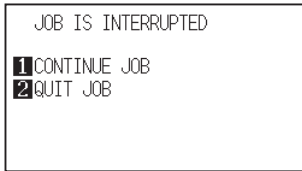

2 Press the [2] key (QUIT JOB).

▶ The following screen is displayed.

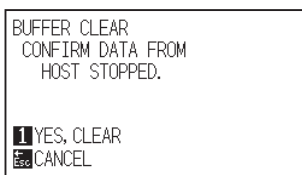

3 Confirm if the data transfer from the computer is stopped and press the [1] key (YES, CLEAR).

▶ The following screen is displayed, the buffer memory is cleared, and it will return to the default screen.

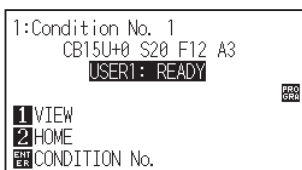

Supplement

It will resume cutting by pressing [1] key (CONTINUE JOB).

See "Pause and Resume Cutting".

Supplement

- It will return to operation stop screen without clearing buffer memory when [ESC] key (CANCEL) is pressed..
- In the case that the operation is interrupted and the buffer is cleared, make sure that the data transfer is stopped. If the data transfer continues, abnormal operations where data is processed from the middle may occur.

Chapter 4: Convenient Functions

This chapter describes about the convenient functions of the plotter.

PRODUCT SUMMARY

- 4.1 Settings for Cutting**
- 4.2 Copy (Duplicate Cutting)**
- 4.3 Dual Configuration**

4.1 Settings for Cutting

Settings such as area and width of cutting, page length, mirrored, enlarged, shrunk, etc., can be set.

Setting Cutting Area

Origin point will be set at lower left of the AREA once the AREA is set. It is possible to set the origin point at the center when the HP-GL is selected.

Move the origin point to change the cutting position.

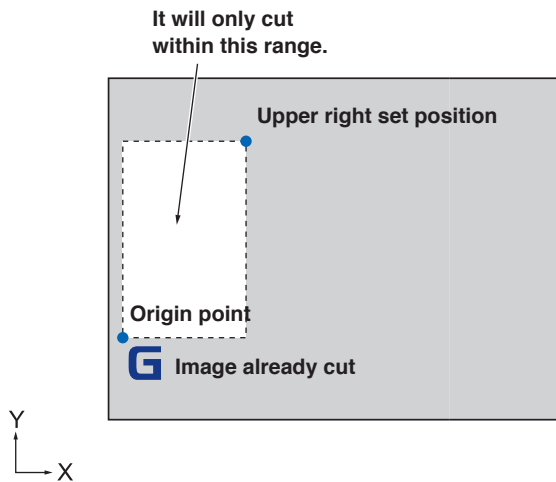

Supplement

- See "Setting the Origin Point" about the moving the origin point.
- See "Setting Origin Point When HP-GL is Set" for setting the origin point with HPGL command.

Operation

1 Press the [PAUSE/MENU] key.

▶ MENU screen is displayed.



2 Press the [3] key (AREA).

▶ AREA PARAMETERS setting screen (1/2) is displayed.

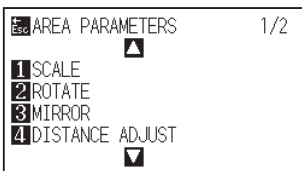

3 Press the POSITION (▲) key.

▶ AREA PARAMETERS setting screen (2/2) is displayed.

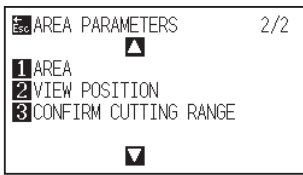

4 Press the [1] key (AREA).

▶ SET LOWER LEFT screen is displayed.

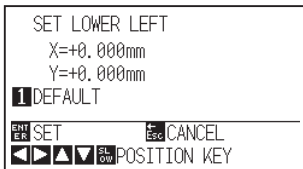

5 Press the POSITION (▲▼◀▶) keys and move the tool carriage to the position to be the lower left of the AREA.

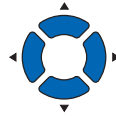

6 Press the [ENTER] key (SET) once the tool carriage is in correct position.

▶ SET UPPER RIGHT screen is displayed.

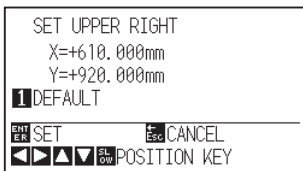

7 Press the POSITION (▲▼◀▶) keys and move the tool carriage to the upper right position of the AREA.

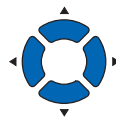

8 Press the [ENTER] key (SET) once the tool carriage is in correct position.

▶ Setting will be set, and it will return to AREA PARAMETER screen (2/2).

9 Press the [PAUSE/MENU] key.

▶ It will return to default screen.

Supplement

- Coordinate value displayed here is the distance to the tool carriage from the origin point.
- Press [1] key (DEFAULT) if the cutting are is not to change.

Supplement

Please set the X and Y cut range for the areas on the upper right and lower left points to at least 10 mm.

An error message will appear for areas that are too small.

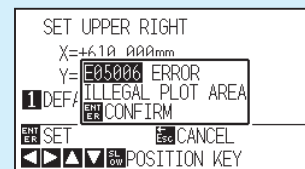

You will need to reset the settings for the upper right and lower left points.

Supplement

It will return to AREA PARAMETERS setting screen (2/2) without changing the settings when you press the [ESC] key (CANCEL).

Setting Mirror

There is a function to mirror the cutting by reversing the origin point and coordinate axes.
Set the MIRROR setting to on do mirroring.

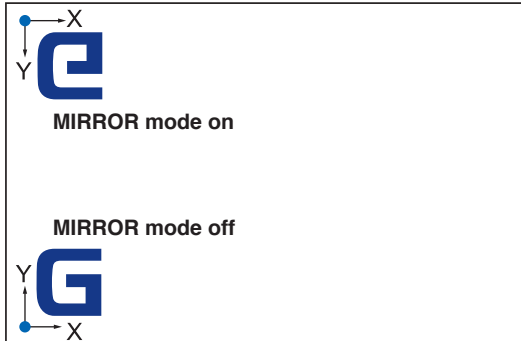

Operation

- 1 Press the [PAUSE/MENU] key.

▶ MENU screen is displayed.



- 2 Press the [3] key (AREA).

▶ AREA PARAMETERS setting screen (1/2) is displayed.

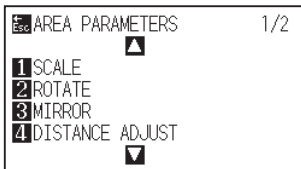

- 3 Press the [3] key (MIRROR).

▶ MIRROR setting screen is displayed.

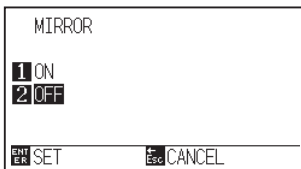

- 4 Press the [1] key (ON).

Supplement

Press the [2] key (OFF) to turn off the mirror.

- 5 Confirm the setting and press the [ENTER] key (SET).
 - ▶ Setting will be set, and it will return to AREA PARAMETERS setting screen (1/2).

- 6 Press the [PAUSE/MENU] key.
 - The tool carriage moves to the coordinate position you set.
 - ▶ It will return to default screen.

Supplement

It will return to AREA PARAMETERS setting screen (1/2) without changing the settings when you press the [ESC] key (CANCEL).

Set the enlarge/shrink scale (Scale)

It can enlarge or shrink cutting.

The rate of enlargement or shrinkage of the cutting data can be changed by settings.

Operation

- 1 Press the [PAUSE/MENU] key.
 - ▶ MENU screen is displayed.

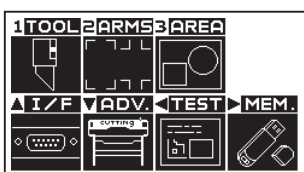

- 2 Press the [3] key (AREA).
 - ▶ AREA PARAMETERS setting screen (1/2) is displayed.

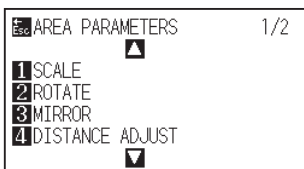

- 3 Press the [1] key (SCALE).
 - ▶ SCALE setting screen is displayed.

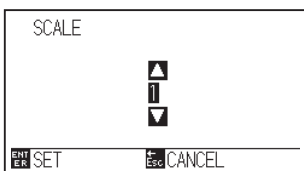

- 4 Press the POSITION (▲▼) keys and increase or decrease the setting value.

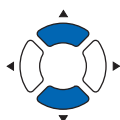

Supplement

Values that can be set are 1/8, 1/4, 1/2, 1, 2, 3, 4, 5, 6, 7, and 8 (multiplications).

- 5 Confirm the setting and press the [ENTER] key (SET).
 - ▶ Setting will be set, and it will return to AREA PARAMETERS setting screen (1/2).

- 6 Press the [PAUSE/MENU] key.
 - ▶ It will return to default screen.

Supplement

It will return to AREA PARAMETERS setting screen (1/2) without changing the settings when you press the [ESC] key (CANCEL).

4.2 Copy (Duplicate Cutting)

The function to cut specified numbers of cutting data stored in the buffer memory is called COPY.

Supplement

- Do not send new data to plotter while copying. Cutting data in the buffer memory will be cleared.
- Previous cutting data will be cleared and newly sent data will be stored as cutting data if you send new data with 10 seconds or more interval from the time it finished cutting.
- It can not copy if data is more than 1.6 MB because it cannot be stored in the buffer memory of the plotter.
- Buffer memory that can be used for copy will decrease if you turn on the data sort. Turn off the data sort when you need to copy cutting with large data. See "Sorting the Cutting Data" for data sort.
- Watch out that it does not fall out of media when cutting with copy function.
- If the original cutting data to be copied starts away from the origin point, copied cutting will also start away from the origin point. To avoid wasted space, create the cutting data close to the origin point. To avoid wasted space, create the cutting data close to the origin point.

When Cutting Data Has No Registration Mark

Copy is performed in following order.

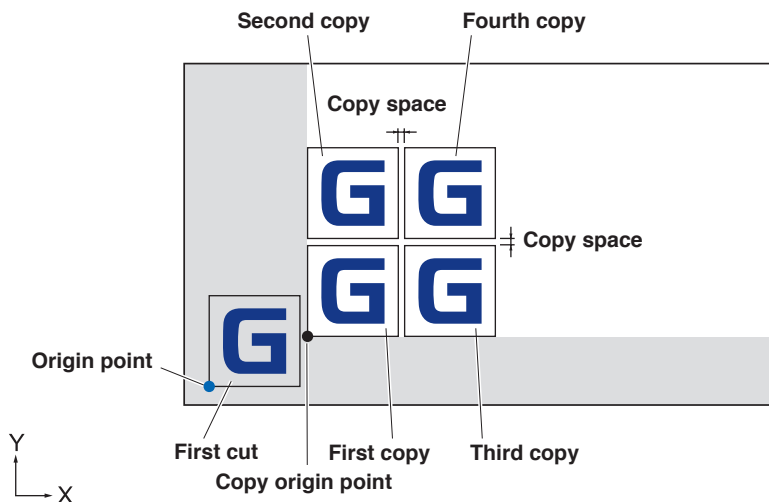

It will copy in following order when MIRROR is set.

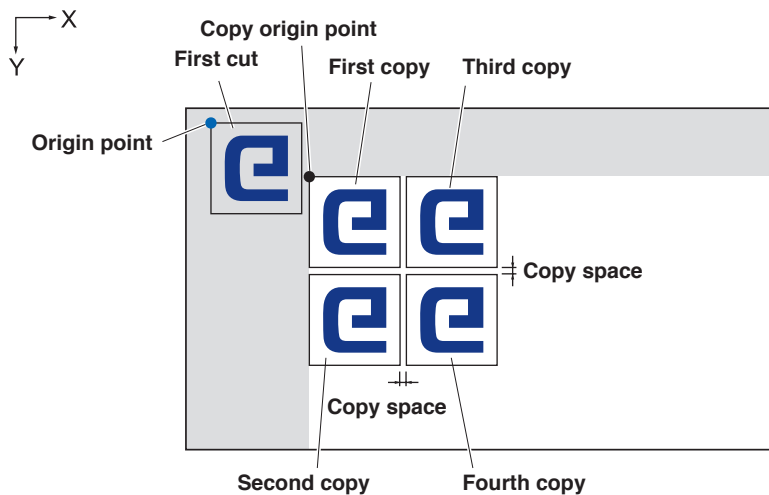

It will copy in following order when COORDINATE AXES ROTATION is set.

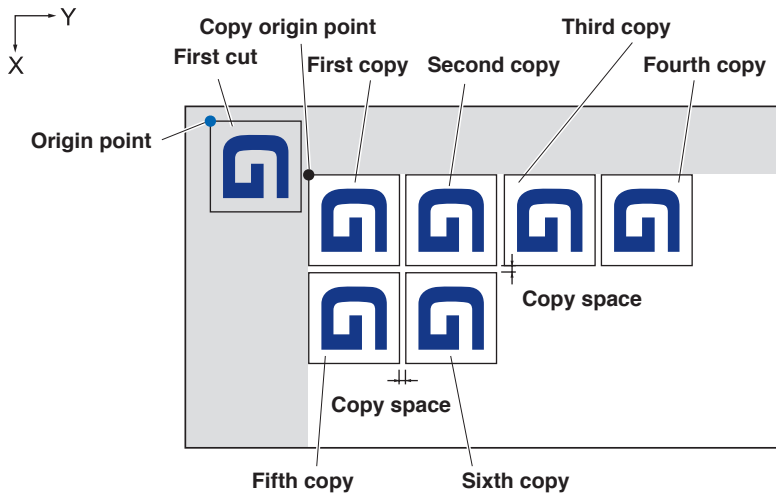

Operation

- 1 Create one cutting data you want to copy.
▶ Cutting data is stored in the buffer memory.
- 2 Press the POSITION (▲▼◀▶) keys and move the tool carriage to the position to copy.

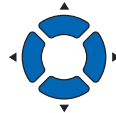

- 3 Press the [COPY] key.
▶ COPY MODE screen is displayed.

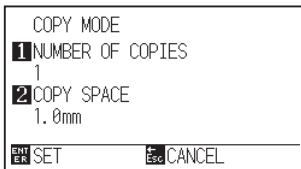

- 4 Press the [1] key (NUMBER OF COPIES).
▶ NUMBER OF COPIES setting screen is displayed.

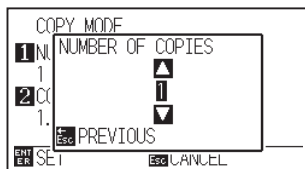

- 5 Press the POSITION (▲▼) key and increase or decrease the setting value.

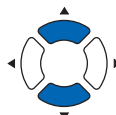

Supplement

- "NO DATA FOR COPY IN BUFFER!" is displayed if there is no data in the buffer memory. Send the cutting data.
- If too much data is sent from the buffer memory, "Copy mode buffer is full!" will be displayed.
- If the data to be copied is larger than the cutting area, "Cannot copy, the valid area is too small" will be displayed.

Supplement

- Number of copies can be set from 1 to 100 as much as it can fit in the media set on the plotter.
- The initial value for the number of copies is always 1.

- 6 Confirm the setting value and press the [ESC] key (PREVIOUS).
 ▶ Number of copies will be selected, and it will return to COPY MODE screen.

Supplement

"CANNOT COPY CUT AREA TOO SMALL!" is displayed if the cutting area is smaller than the copy data. Either expand the cutting area, or set the media that is big enough to copy.

- 7 Press the [2] key (COPY SPACE).
 ▶ COPY SPACE setting screen is displayed.

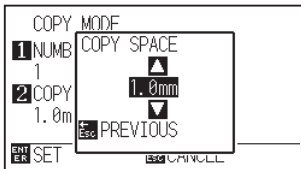

Supplement

- Copy space can be set from 1.0 mm to 10.0 mm.
- This setting is maintained even if the power is turned off.

- 8 Press the POSITION (▲▼) keys and increase or decrease the setting value.

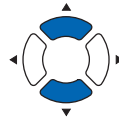

- 9 Confirm the setting value, and press the [ESC] key (PREVIOUS).
 ▶ Copy space will be selected, and it will return to COPY MODE screen.

- 10 Confirm the setting and press the [ENTER] key (SET).
 ▶ "COPY" is displayed on the screen, and it will copy as much as specified.

Supplement

Cutting data is stored even if the media is exchanged. It can be copied as many times until the buffer memory is cleared. It can be copied again after exchanging the media by pressing [COPY] key.

When Cutting Data Has Registration Marks

Copy is performed in following order.

The CHANGE MEDIA message is displayed each time when ending a single cut.

Press the [ENTER] key after changing the media. The cutting area (cut) is copied.

Media change copies can be made up to the set copy number (designated number).

Operation

- 1 Create one cutting data you want to copy.
 ▶ Cutting data is stored in the buffer memory.
- 2 Press the POSITION (▲▼◀▶) keys and move the tool carriage to the position to copy.



3 Press the [COPY] key.

▶ COPY MODE screen is displayed.

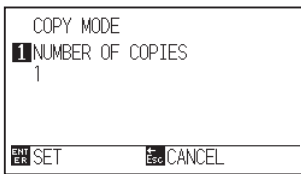

4 Press the [1] key (NUMBER OF COPIES).

▶ NUMBER OF COPIES setting screen is displayed.

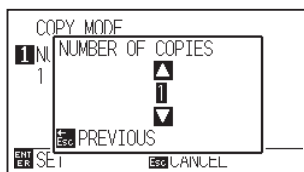

5 Press the POSITION (▲▼) key and increase or decrease the setting value.

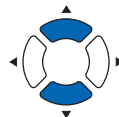

6 Confirm the setting value and press the [ESC] key (PREVIOUS).

▶ Number of copies will be selected, and it will return to COPY MODE screen.

7 Confirm the setting and press the [ENTER] key (SET).

▶ The plotter starts a copy immediately.

Supplement

- The **CHANGE MEDIA** a message is displayed each time when ending a single cut.

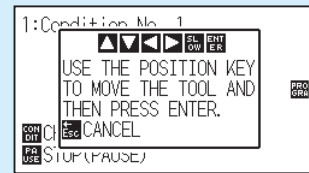

"If the [ESC] key (CANCEL) is pressed, copying will be suspended and it will return to the default screen.

- If there is no data in the buffer memory, "There is no data for copying in the buffer" will be displayed. Please send cutting data.
- If too much data is sent from the buffer memory, "Copy mode buffer is full!" will be displayed.

Supplement

The copy number can be set from 1 to 100.

Supplement

"CANNOT COPY CUT AREA TOO SMALL!" is displayed if the cutting area is smaller than the copy data. Either expand the cutting area, or set the media that is big enough to copy.

8 Change the media.

- ▶ "USE THE POSITION KEY TO MOVE TOOL AND THEN PRESS ENTER." will be displayed on the screen.

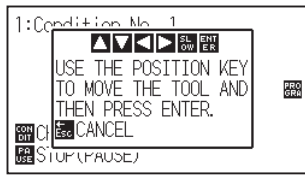

9 The plotter starts a copy immediately after changing the media.

This operation's specified number of copies will be repeated.
To suspend, press the [ESC] key (CANCEL).

Supplement

Cutting data is stored even if the media is exchanged. It can be copied as many times until the buffer memory is cleared. It can be copied again after exchanging the media by pressing [COPY] key.

4.3 Dual Configuration

This plotter can save independently the two types of settings. This is called "dual configuration".

Using the dual configuration, the setting can be quickly switched to other settings.

When worked with two operators, the settings for each operator can be saved separately, in addition, the two types of settings that conform to the media can be saved, the operator can switch quickly the condition settings at the time of the media replacement.

Dual configuration is done by selecting the user.

There are USER 1 (upper LED lights) and USER 2 (lower LED lights) as a user.

Supplement

When the user is switched USER 1 to/from USER 2, the cutting data will disappear.

Selecting the user

Operation

- 1 Press the [USER1/2] key in the default screen.

▶ User changing screen is displayed.

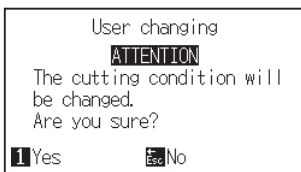

- 2 Press the [1] key (Yes).

The "USER 1/2 lamp" that is switched by the [USER1/2] key lights.

▶ The user is selected and then the plotter is reset.

Supplement

When the "User Key" is set to "DISABLED", the error message is displayed.



Please set the "User Key" to "ENABLED" in the ADV. setting screen.

Chapter 5: ARMS

(Advanced Registration Mark Sensing System)

ARMS (Advanced Registration Mark Sensing System) is a function to scan the registration mark written on the media using sensors.

Tilt of the axes and distance can be adjusted with 2POINTS or 3POINTS. 2 axes warp adjustment can be adjusted in addition to axes adjustment (tilt) and distance adjustment with 4POINTS.

When cutting the outlines of the printed figure, and when re-cutting media, using ARMS to adjust for printing position discrepancies, high precision cutting can be done.

It is possible to perform a multiple registration mark adjustment or segment area adjustment by linking with the application software on the computer. See the operation guides of the application software about the registration mark adjustment function linked with the application software.

This chapter describes the outline of the ARMS (Advanced Registration Mark Sensing System) and how to set and use the ARMS on the control panel.

PRODUCT SUMMARY

5.1 Outline of ARMS

5.2 Setting and Adjustment of ARMS

5.3 Setting the Position Using ARMS

5.1 Outline of ARMS

ARMS (Advanced Registration Mark Sensing System) scans the registration mark (reference line) written on the media using sensors.

Registration mark scanning accuracy when a designated registration mark is being scanned by this machine is within 0.3 mm.

Please take note of the following when scanning a registration mark. Cutting area and width, page length, certificate, zooming in/out can all be set.

- Shape (Pattern) of the registration mark
- Scan range necessary to sense the registration mark
- Position of the origin point and the registration mark
- Cutting area when adjusting the registration mark
- Automatic sensing of registration mark position
- Media that registration mark cannot be sensed

Shape (Pattern) of the Registration Mark

The shapes (patterns) of the registration mark that the plotter can scan are 6 types.

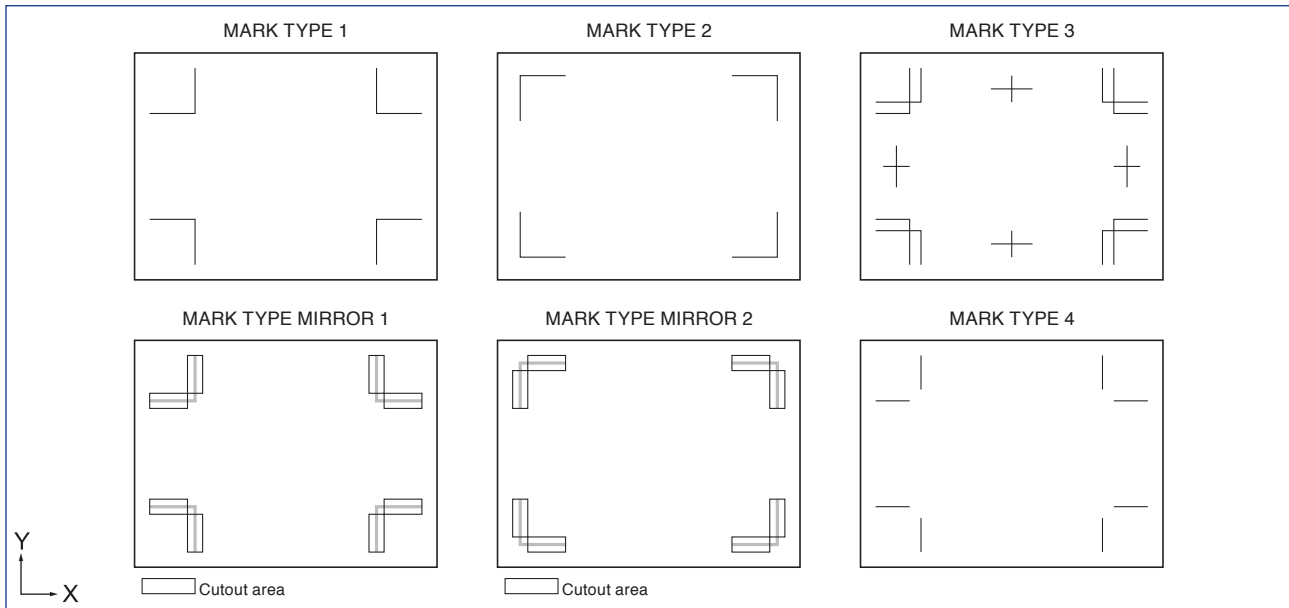

Supplement

- Create the registration mark as a plotting data with the application software. Using the Adobe Illustrator, create the registration marks 3 and 4.
- Create the registration mark in accordance with following conditions.
 - Thickness of the line is between 0.3 to 1.0 mm.
 - Size of the registration mark is between 5 to 20 mm.
 - Use one of Pattern 1 to Pattern 4 for the shape of registration mark.
 - Create the registration mark with single line, and specify the thickness of line to necessary thickness. Double line cannot be used.

Scan Range Necessary to Sense the Registration Mark

The range of tool carriage and media movement needed to scan the registration mark is as following.
Do not print in the shaded area shown in the Figure below.

For 3POINTS

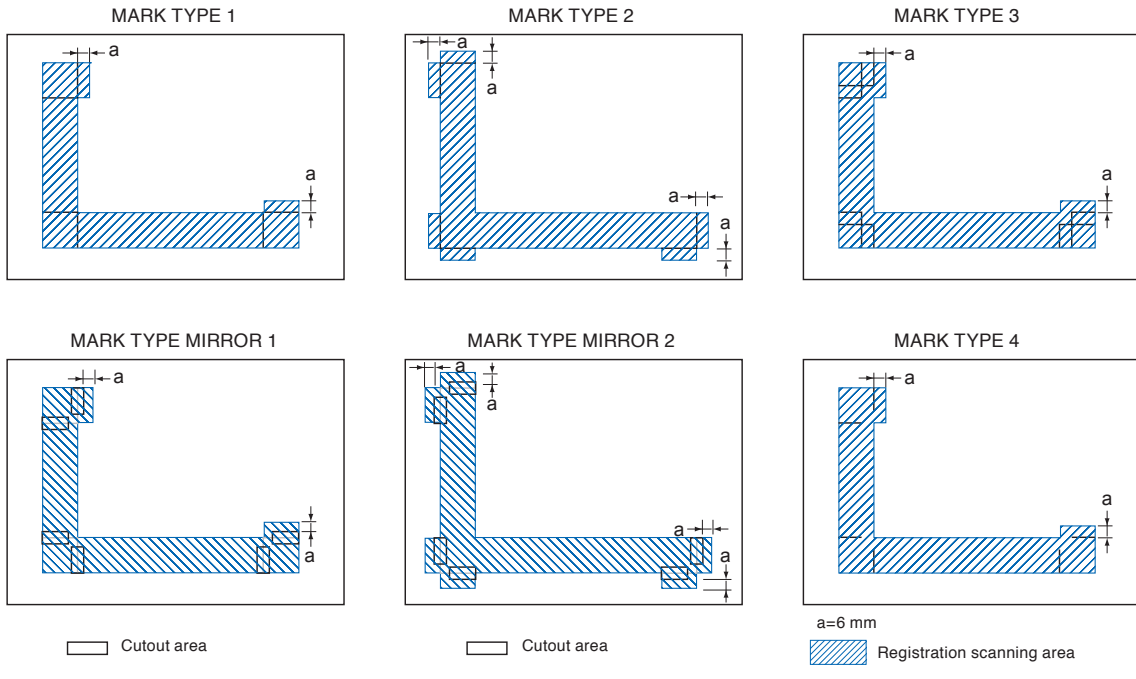

For 4POINTS

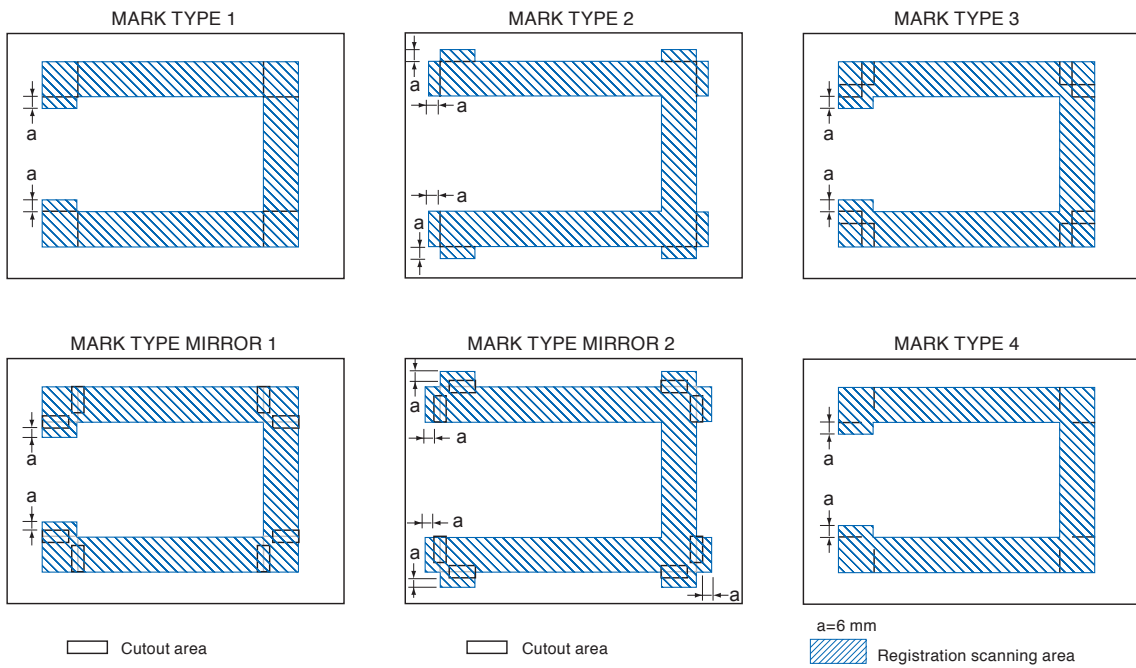

The area necessary to scan the registration mark when the Mark Distance is set is as following:

Do not print in the shaded area shown in the Figure below.

For 3POINTS

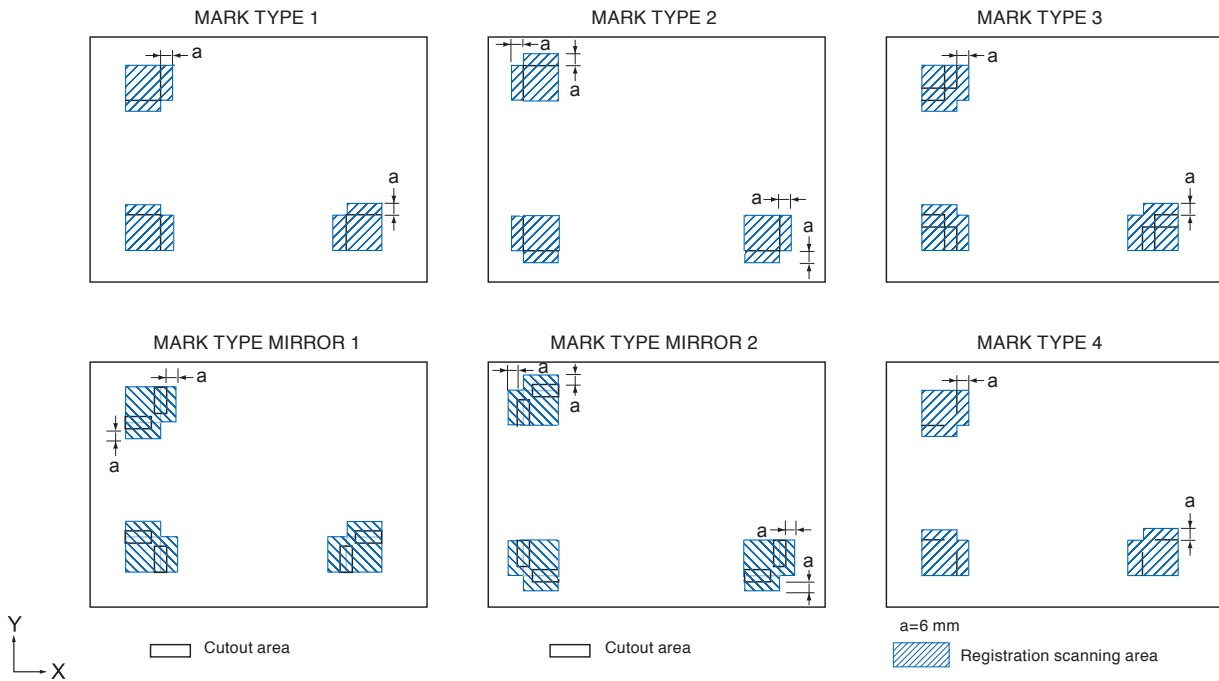

For 4POINTS

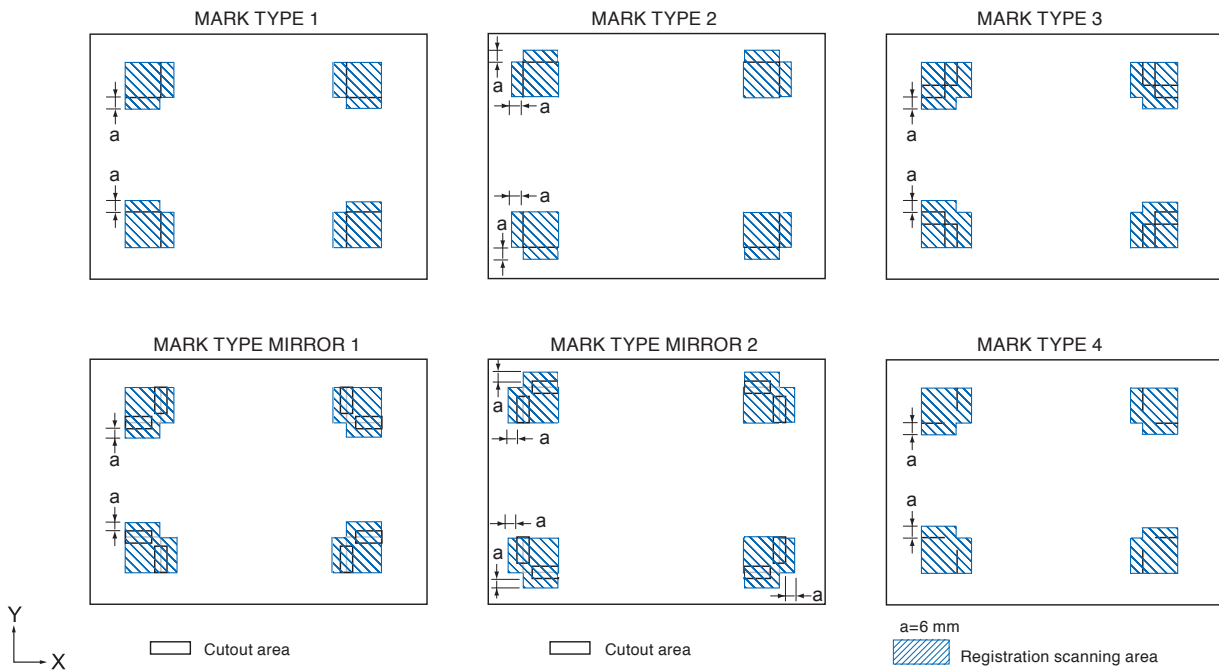

Supplement

- See "Setting Shape (Pattern) of Registration Mark" to change the shape (pattern) of the registration mark.
- See "Setting Mark Distance" for setting Mark Distance.
- It may mistakenly sense as registration mark if there is anything else plotted within the registration mark scanning area. Adjust the "MARK DISTANCE" so it can scan the registration mark correctly. (See "Setting Mark Distance")
- Clean any dirt or foreign objects from the media. Any dirt or foreign object might be scanned mistakenly as registration mark.
- Plot the registration mark in contrast easy to scan, such as black lines on white background. Adjust the scanning level of the sensor if you need to use the colored or glossy media. (See "Adjusting the Sensor Level ")

Position of the Origin Point and the Registration Mark

The origin point after scanning the registration mark will be as shown below.

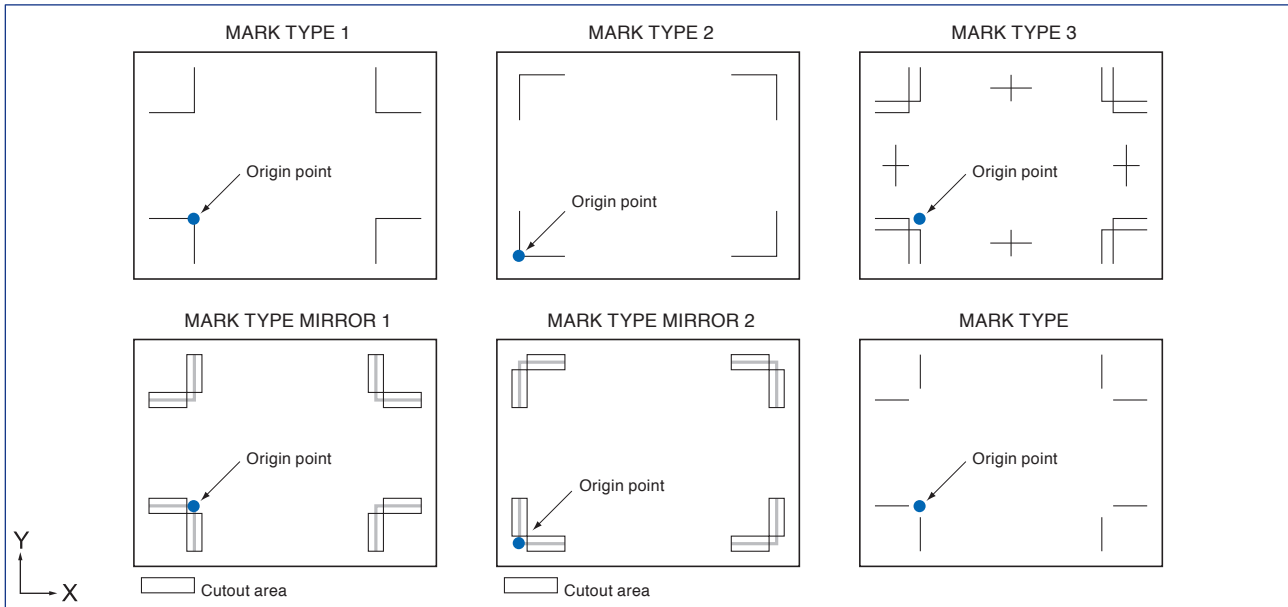

Supplement

Offset amount away from the registration mark will be the origin point for cutting if the registration mark offset is set. (See "Setting Offset Between the Registration Mark and Cutting Origin Point")

The condition offset is generated is explained with creating the registration mark and the cutting data using an application software on the computer as an example.

Print onto the sheet media using a printer, and set that sheet media on the cutting plotter. Send the cutting data from the computer to cutting plotter.

Also, scan the registration mark on the sheet media with the cutting plotter, determine the origin point of the plotter.

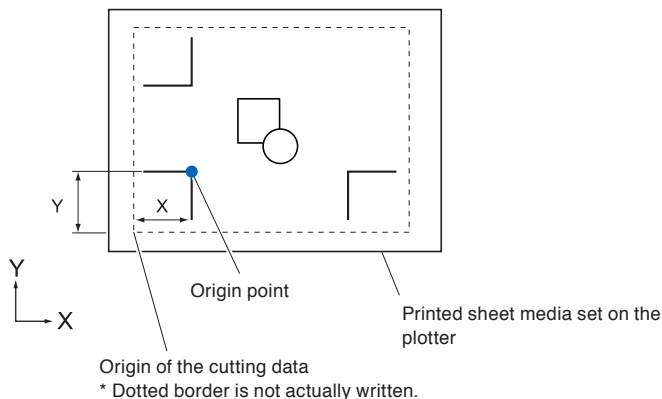

The origin point of the plotter will be set as the registration mark origin point as shown above, and it is different from the origin point of the cutting data. The difference between these two origin points are called as offset.

In case of the figure above, set x and y to the cutting plotter as a registration mark offset.

It can cut properly by setting the offset value to the cutting plotter.

There are following methods to measure the offset.

- Cutting data is checked on the computer, and the distance between the origin point of the cutting data and the registration mark origin point is measured.

Cutting area when adjusting the registration mark

Even when adjusting the registration mark, you can cut the outside of the registration mark (cutting area).

Supplement

If the distortion due to the adjustment is large, there is a possibility that the cutting area is reduced.

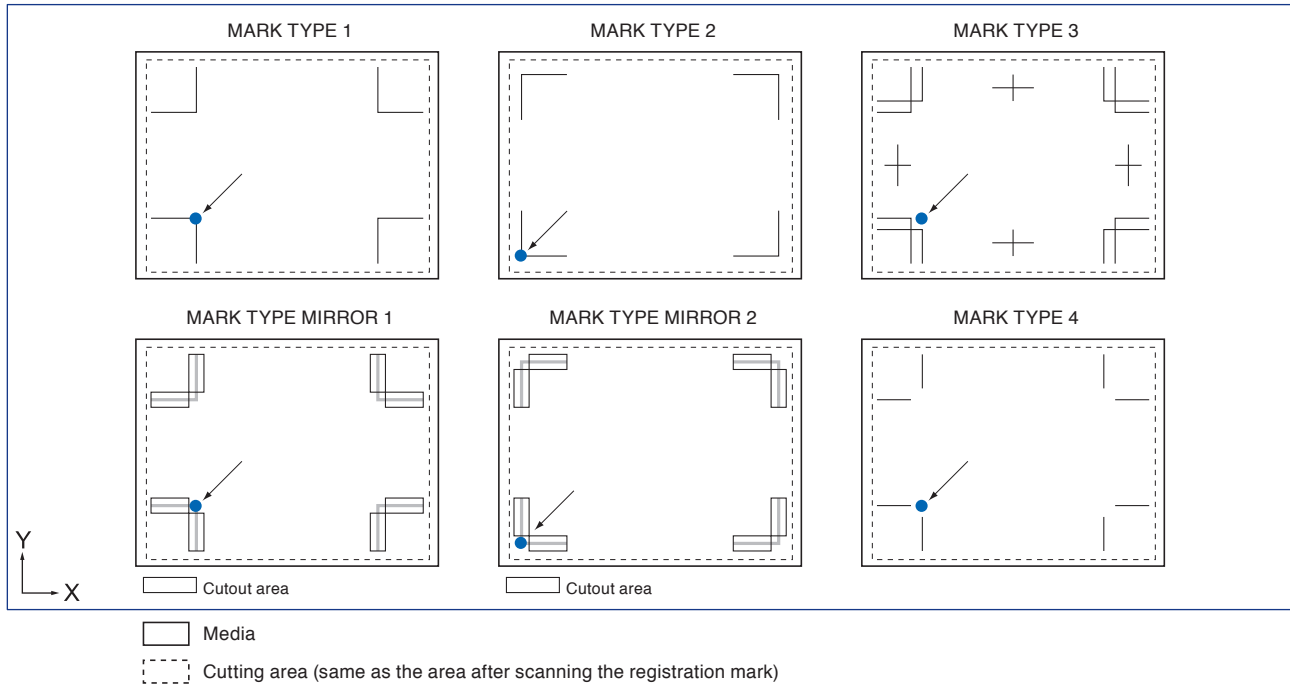

Automatic sensed of registration mark position

The registration mark is sensed within area A from the registration mark scanning start position (tool position). When the registration mark is not sensed within the area A, then within area B is sensed. Only when the registration mark is present in area A or B, it is possible to recognize as the mark.

Unit: approx. mm

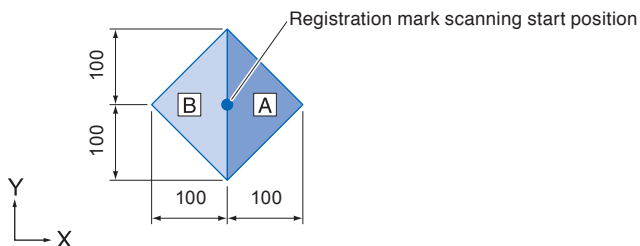

Media That Registration Mark Cannot be Sensed

It may be hard to scan the registration mark as following, depending on the media conditions.

- Transparent media

Registration mark cannot be scanned because the lighting panel surface is also scanned.

- Registration mark other than black line on white background

Sensitivity of the sensor is based on the registration mark written in black on white background. It makes harder to scan the registration mark on colored background or written in colors other than black. Adjust the sensitivity level of the sensor. (See "Adjusting the Sensor Level")

- Sloppy plotting and media

Registration mark may not be scanned if the surface is dirty, bent, or the lines are blurred.

 **CAUTION**

The registration marks on the laminated media might not be scanned due to the gloss of the laminate. Please try to test preliminarily.

Supplement

Use the axes adjustment function if the automatic registration mark scan is not possible. (See "Manual Position Adjust")

5.2 Setting and Adjustment of ARMS

This section describes the necessary adjustment and settings to correctly scan the registration mark with ARMS.

- Setting MARK SCAN MODE and Numbers
- Setting Shape (Pattern) of Registration Mark
- Setting Registration Mark Size
- Setting Mark Distance
- Distance Adjustment Between the Registration Mark
- Setting Offset Between the Registration Mark and Cutting Origin Point
- Adjusting the Sensor Level
- Manually Adjusting the Sensor Level (Threshold Value)
- Test the Registration Mark Sensor
- Setting Speed of the Registration Mark Scan
- Adjusting for the Registration Mark Scan Position

Setting MARK SCAN MODE and Numbers

Set the MARK SCAN mode to ARMS to perform automatic registration mark scan.

Supplement

There are "AXIS ALIGNMENT" and "OFF" in addition to "ARMS" in the MARK SCAN MODEs. To turn "OFF", select "OFF" for the mode in following procedures. See "Manual Position Adjust" for AXIS ALIGNMENT".

Set the numbers of registration marks when the MARK SCAN MODE is set to ARMS. Select the POINTS from 2POINTS, 3POINTS, or 4POINTS. Position of the registration marks for each is as following.

2POINTS

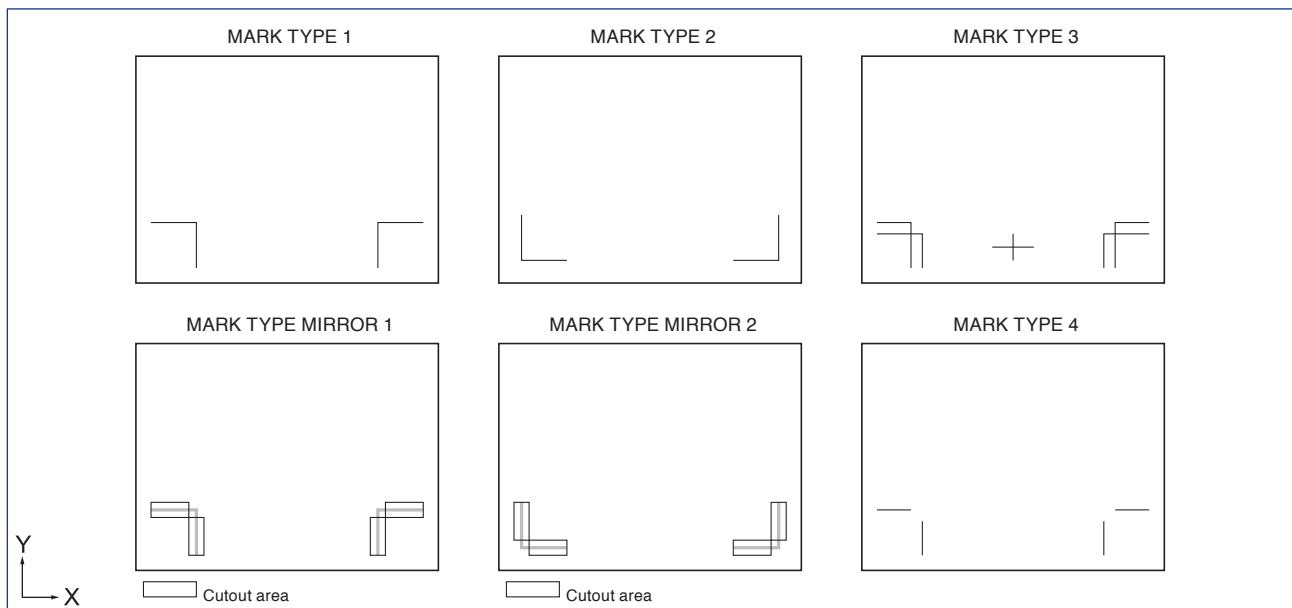

3POINTS

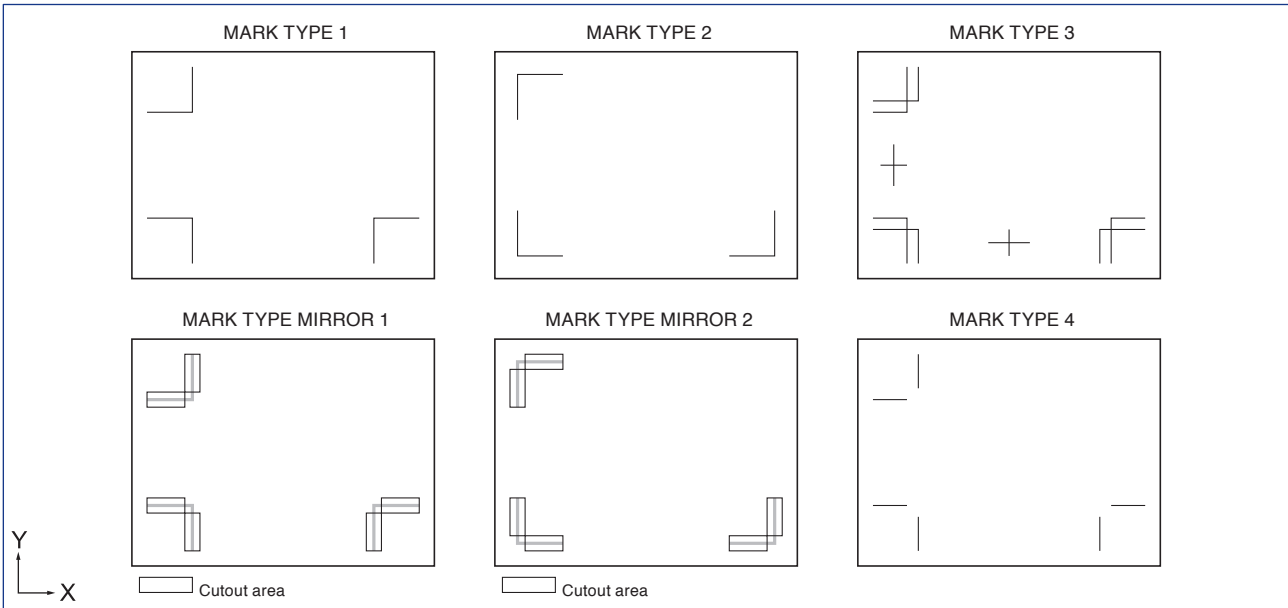

4POINTS

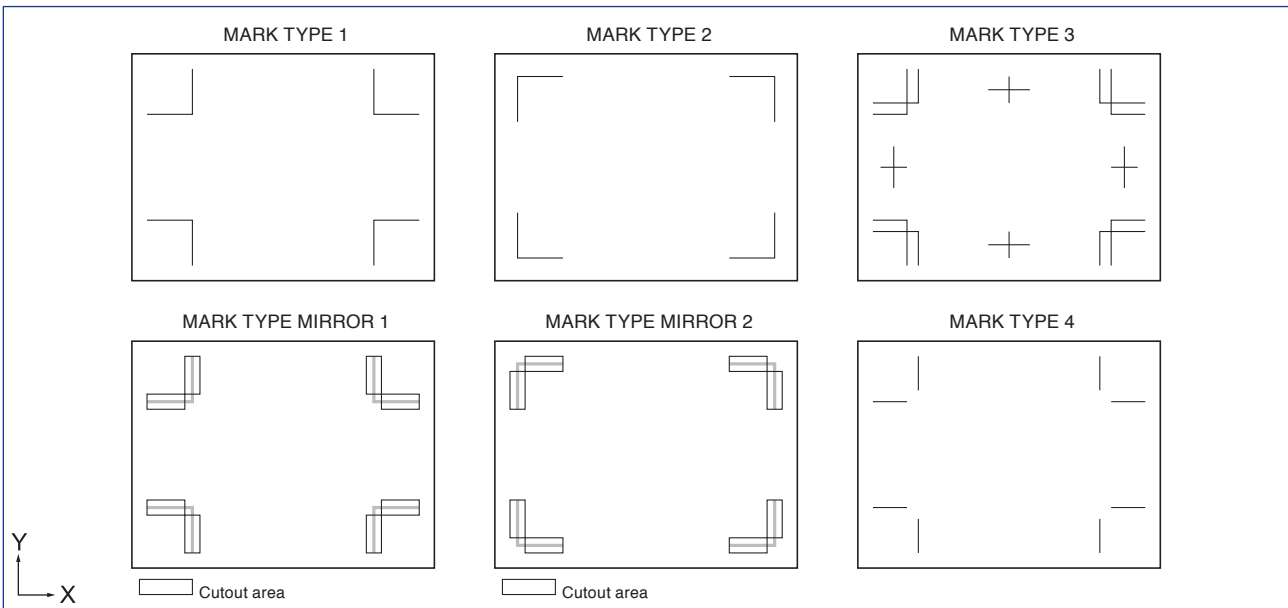

With more registration marks, precision of matching the printed image and the cutting will increase. But if there are many registration marks, it will take longer to sense, and the area that can be cut becomes smaller.

1 axis adjustment (2POINT sensing)

Supplement

- Multiple registration marks (Alignment registration mark) is not available. (See the "Multiple registration marks [Alignment registration mark])
- The printable range on the figure below is for when the Mark Distance is not specified. The cutting area changes depending on the Mark Distance that is set.

It will detect the tilt of the printing from 2 registration marks, and cut is performed matching the tilt of the print.

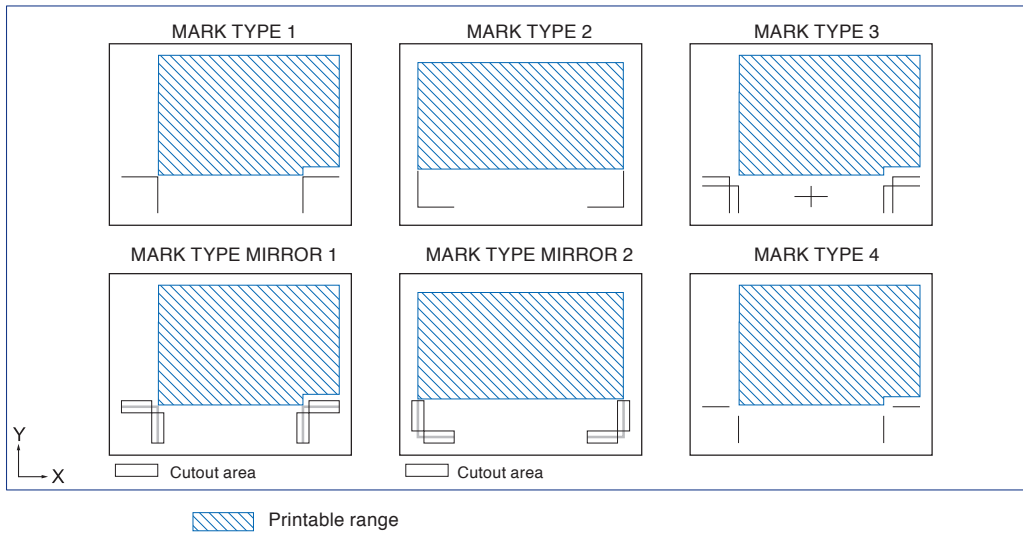

2 axes adjustment (3POINTS sensing)

Supplement

- Distance between the registration marks can be adjusted.
- Multiple registration marks (Alignment registration mark) is available. (See the "Multiple registration marks [Alignment registration mark])
- The printable range on the figure below is for when the Mark Distance is not specified. The cutting area changes depending on the Mark Distance that is set.

It will sense the vertical and horizontal tilts from 3 registration marks, and cut is performed matching the tilt of the print. Precision of print and cut position will be higher than the 1 axis adjustment.

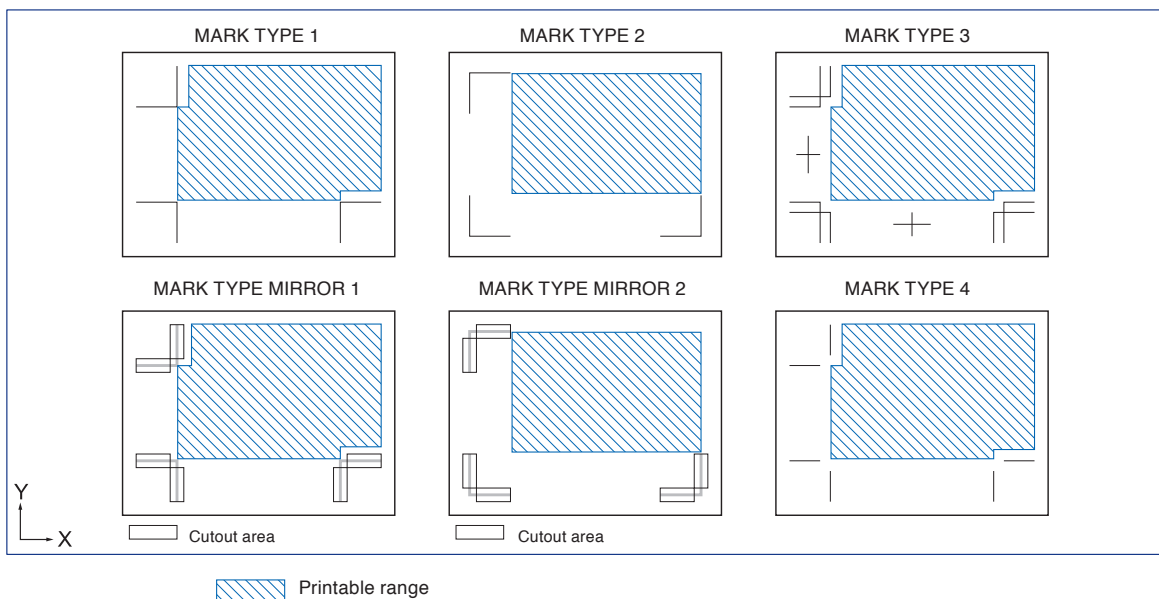

4 axes adjustment (4POINTS sensing)

Supplement

- Distance between the registration marks can be adjusted.
- Multiple registration marks (Alignment registration mark) is available. (See the "Multiple registration marks [Alignment registration mark] ")
- The printable range on the figure below is for when the Mark Distance is not specified. The cutting area changes depending on the Mark Distance that is set.

It will sense the left and right vertical tilts and upper and lower horizontal tilt from 4 registration marks, and cut is performed matching the tilt of the print.

Precision of print and cut position will be higher than the 2 axes adjustment.

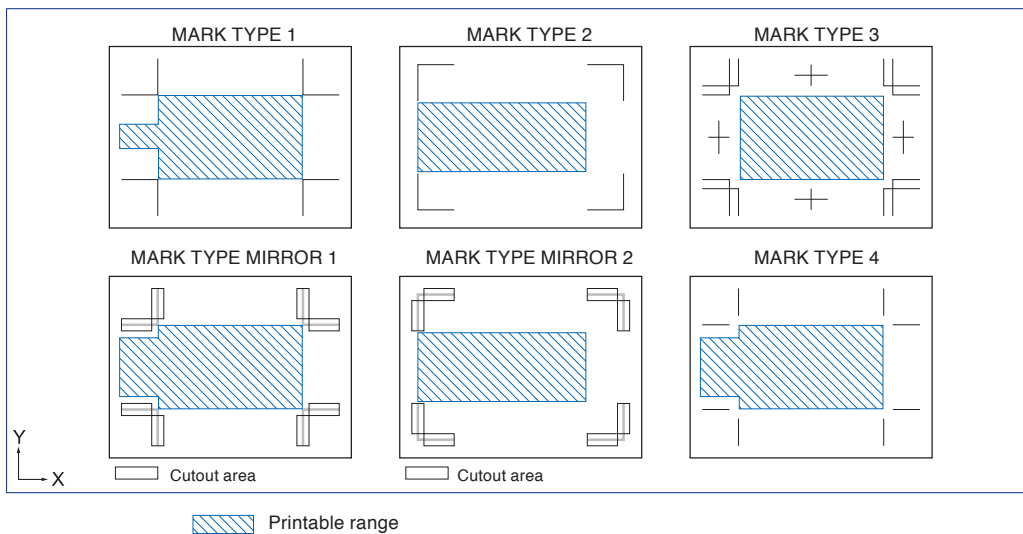

Multiple registration marks (Alignment registration mark)

Supplement

- Setting is only possible from the Application software.
- It cannot be set on the plotter.

A function to continuously cut the print with same design aligned, using a plugin for the Illustrator. It is appropriate for cutting multiple numbers of stickers or similar.

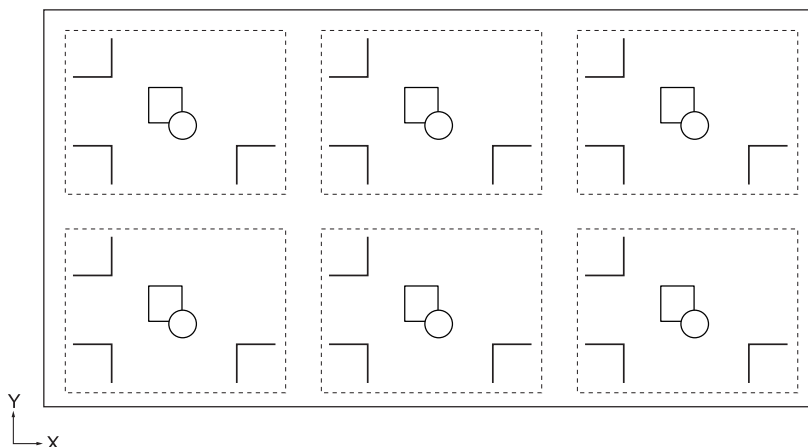

Operation

- 1 Press the [PAUSE/MENU] key.

▶ MENU screen is displayed



- 2 Press the [2] key (ARMS).

▶ ARMS SETTING screen (1/5) is displayed.

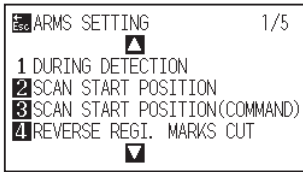

- 3 Press the POSITION (▲) key.

▶ ARMS SETTING screen (2/5) is displayed.

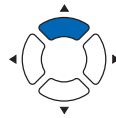
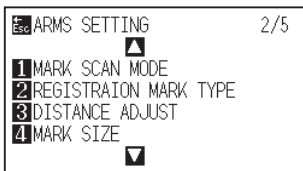

- 4 Press the [1] key (MARK SCAN MODE).

▶ MARK SCAN MODE screen is displayed

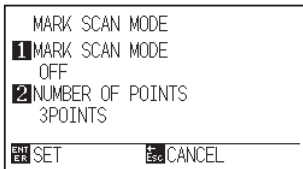

- 5 Press the [1] key (MARK SCAN MODE).

▶ MARK SCAN MODE setting screen is displayed.

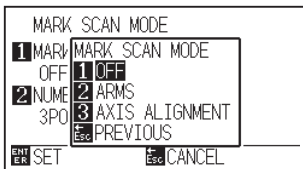

- 6 Press the [2] key (ARMS).

▶ MARK SCAN MODE is selected and it will return to MARK SCAN MODE setting screen.

Supplement

It will return to MARK SCAN MODE setting screen without changing the settings when you press the [ESC] key (CANCEL).

7 Press the [2] key (NUMBER OF POINTS).

▶ NUMBER OF POINTS screen is displayed

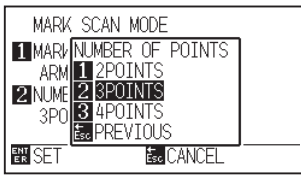

8 Press the [1] key (2POINTS), the [2] key (3POINTS) or the [3] key (4POINTS).

▶ This will select the number of registration marks and return you to the REGISTRATION MARK MODE setting screen.

9 Confirm the setting and press the [ENTER] key (SET).

▶ Setting will be set, and it will return to ARMS SETTING screen (2/5).

10 Press the [PAUSE/MENU] key.

▶ It will return to default screen.

Supplement

It will return to ARMS setting screen (2/5) without changing the settings when you press the [ESC] key (CANCEL).

Setting Shape (Pattern) of Registration Mark

Preset the shape (pattern) of registration marks to scan.

Operation

1 Press the [PAUSE/MENU] key.

▶ MENU screen is displayed



2 Press the [2] key (ARMS).

▶ ARMS SETTING screen (1/5) is displayed.

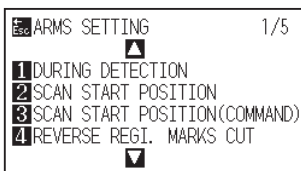

3 Press the POSITION (▲) key.

▶ ARMS SETTING screen (2/5) is displayed.

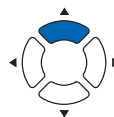
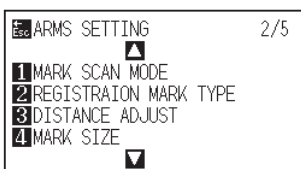

4 Press the [2] key (REGISTRAION MARK).

▶ REGISTRAION MARK TYPE setting screen is displayed.

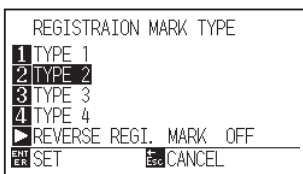

5 Press the [1] key (TYPE 1), the [2] key (TYPE 2) or the [3] key (TYPE 3).

When the TYPE 1 or 2 is selected, pressing the (▶) key can switch the REVERSE REGISTRATION MARK to ON/OFF.

When the TYPE 3 is selected, the pacing and center (center registration mark) are set.

When the TYPE 4 is selected, the pacing is set.

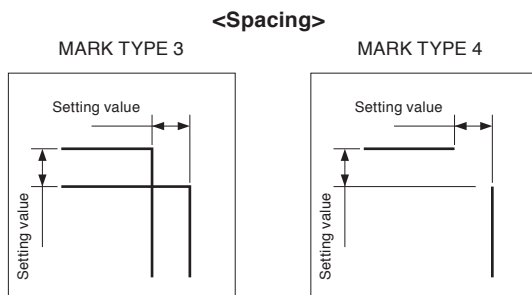

The center registration mark can only be scanned for registration mark pattern 3, when the number of registration marks is 2POINTS or 3POINTS and only when "USER" has been selected.

Enter the distance from the registration mark scanning area in the W.

In the case shown in the figure below, the W is a negative value.

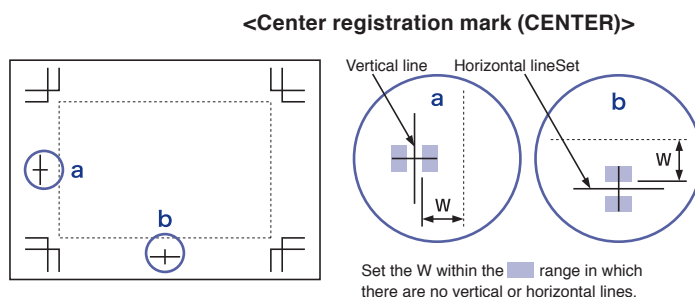

6 Confirm the setting and press the [ENTER] key (SET).

▶ Setting will be set, and it will return to ARMS SETTING screen (2/5).

7 Press the [PAUSE/MENU] key

▶ It will return to the default screen.

Supplement

- It will return to ARMS setting screen (2/5) without changing the settings when you press the [ESC] key (CANCEL).
- The REVERSE REGISTRATION MARK to ON setting is canceled when the power is turned off.

Supplement

For the registration mark patterns, see "Outline of ARMS".

Supplement

Spacing range is 0 to 9.9 (mm).

The W value range of the center registration mark (CENTER) is -99.9 to +99.9 (mm).

Supplement

It will return to ARMS setting screen (2/5) without changing the settings when you press the [ESC] key (CANCEL).

Setting Distance Adjustment Between the Registration Marks

If the distance between the registration marks is shifted from the original value of the data, the shift is adjusted for the cutting to reflect the ratio, which is calculated from the amount of shift. This is called the distance adjustment between the registration marks.

There are three types of mode for the registration mark adjustment.

- USER** : Manually enter the original value of the data for the distance between the scanned registration marks to adjust it.
- CUSTOM** : When outputting the distance between the registration marks in any multiple of 5, 10 or 50 mm, the distance between the registration marks is automatically adjusted after the unit value is set to "CUSTOM UNIT". For example, when the "CUSTOM UNIT" is set to 5 mm and the distance between the scanned registration marks is 312 mm, the distance adjustment is performed, regarded as the ideal value of the distance between the registration marks is 310 mm after the distance of less than 5 mm is rounded off.
- STANDARD** : One value of 5, 10 or 50 mm is automatically selected as the unit value depending on the settings of the distance between the registration marks (see "Setting Mark Distance"). The distance between the scanned registration marks is regarded as the original value of the data after the distance of less than reference value is rounded off and the distance adjustment is performed.

The following values are used depending on the length.

Length of more than 1 m	50 mm
Length of more than 50 cm	10 mm
A length of less than or equal to 50 cm	5 mm

Operation

- 1 Press the [PAUSE/MENU] key.

▶ MENU screen is displayed.



- 2 Press the [2] key (ARMS).

▶ ARMS SETTING screen (1/4) is displayed.

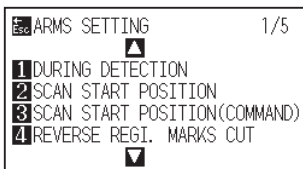

- 3 Press the POSITION (▲) key.

▶ ARMS SETTING screen (2/5) is displayed.

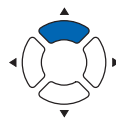
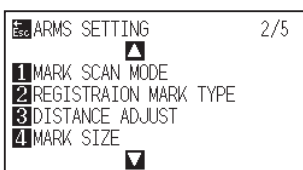

4 Press the [3] key (DISTANCE ADJUST).

▶ DISTANCE ADJUST setting screen is displayed.

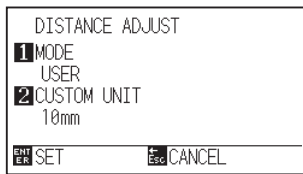

5 Press the [1] key (MODE).

▶ DISTANCE ADJUST setting screen is displayed.

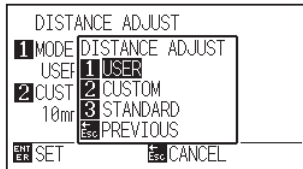

6 Press the [1] key (USER), the [2] key (CUSTOM), or the [3] key (STANDARD).

▶ Mode is selected and it will return to DISTANCE ADJUST screen.

7 The procedures are different depending on the selected mode.

When USER or STANDARD modes are selected

Jump to step 9.

When CUSTOM mode is selected

Press the [2] key (CUSTOM UNIT).

▶ CUSTOM UNIT selection screen is displayed.

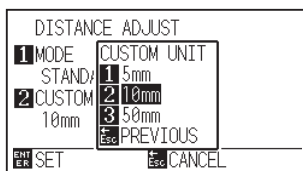

8 Press the [1] key (5mm), the [2] key (10mm), or the [3] key (50mm).

▶ CUSTOM UNIT is selected and it will return to DISTANCE ADJUST screen.

9 Confirm the setting and press the [ENTER] key (SET).

▶ Setting will be set, and it will return to ARMS SETTING screen (2/5).

10 Press the [PAUSE/MENU] key.

▶ It will return to default screen.

Supplement

It will return to ARMS setting screen (2/5) without changing the settings when you press the [ESC] key (CANCEL).

Supplement

It will return to DISTANCE ADJUST setting screen without changing the settings when you press the [ESC] key (CANCEL).

Supplement

It will return to DISTANCE ADJUST setting screen without changing the settings when you press the [ESC] key (CANCEL).

Setting Registration Mark Size

The size of registration mark that is scanned should be preset.

Size of the registration mark that can be set is from 5 mm to 20 mm.

If there is unbalance (skewing) or printing error present in the set media, it will be easier to sense registration marks with larger sizes. However, if the registration mark is large, then the cutting area will become tighter.

MARK TYPE 1, MIRROR 1

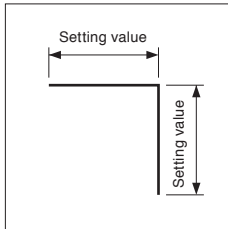

MARK TYPE 2, MIRROR 2

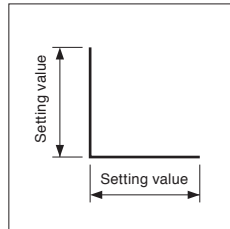

MARK TYPE 3

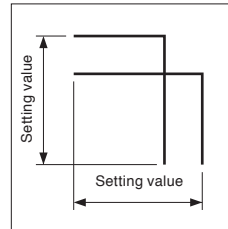

MARK TYPE 4

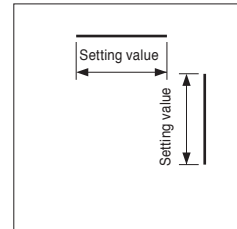

When the registration marks are sensed, it will start from the lower left registration mark on the document, and sense the next registration mark in the horizontal and vertical direction.

If the print is tilted, the short registration mark will be outside the sensing area.

Operation

- 1 Press the [PAUSE/MENU] key.

▶ MENU screen is displayed.

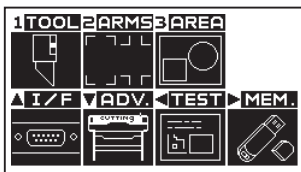

- 2 Press the [2] key (ARMS).

▶ ARMS SETTING screen (1/5) is displayed.

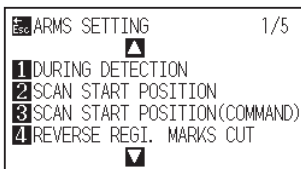

- 3 Press the POSITION (▲) key.

▶ ARMS SETTING screen (2/5) is displayed.

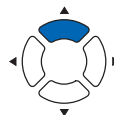
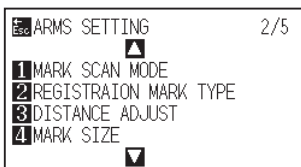

4 Press the [4] key (MARK SIZE).

▶ MARK SIZE setting screen is displayed.

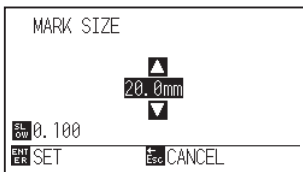

Supplement

It will return to ARMS SETTING screen (2/4) without changing the settings when you press the [ESC] key (CANCEL).

5 Press the POSITION (▲▼) keys and increase or decrease the setting value.

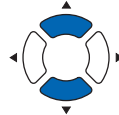

6 Confirm the settings and press the [ENTER] key (SET).

▶ Setting will be set, and it will return to ARMS setting screen (2/5).

7 Press the [PAUSE/MENU] key.

▶ It will return to default screen.

Setting Mark Distance

Mark distance is set so it will not perform sensing of the location where the registration marks are not present. This allows to scan the registration marks faster, and also prevents malfunction by the dirty media.

Supplement

- For the Mark Distance, see “Outline of ARMS”.
- Detection is started from the position of the registration mark size before the specified distance.
- Skipping of the distance between the registration marks will not be performed until next registration mark is found when the mark distance is set to 0 mm.
- Value of Y is ignored it is 2POINTS.

Operation

1 Press the [PAUSE/MENU] key.

▶ MENU screen is displayed

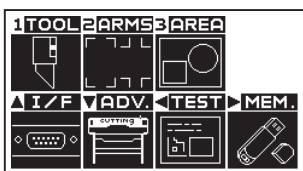

2 Press the [2] key (ARMS).

▶ ARMS SETTING screen (1/5) is displayed.

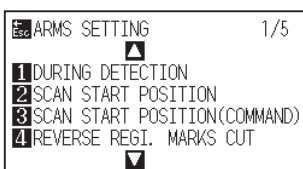

3 Press the POSITION (▲) key twice.

▶ ARMS SETTING screen (2/5) is displayed.

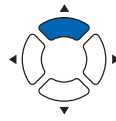
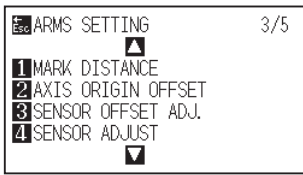

4 Press the [1] key (MARK DISTANCE).

▶ MARK DISTANCE setting screen is displayed.

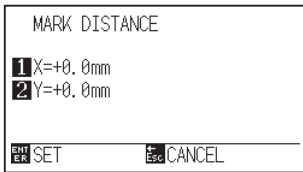

Supplement

It will return to ARMS SETTING screen (3/5) without changing the settings when you press the [ESC] key (CANCEL).

5 Press the [1] key (X).

▶ X AXIS setting screen is displayed.

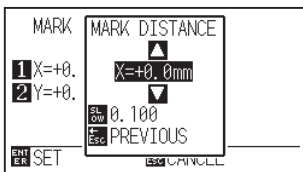

6 Press the [ESC] key and increase or decrease the setting value.

Supplement

- Digits of settings can be changed by pressing the [SLOW] key.
- Setting range is 0.0 mm up to the upper limit of the cutting area.

7 Confirm the setting and press the [ESC] key (PREVIOUS).

▶ MARK DISTANCE is selected and it will return to MARK DISTANCE screen.

8 Press the [2] key (Y).

▶ Y AXIS setting screen is displayed.

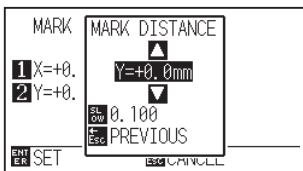

9 Press the POSITION (▲▼) keys and increase or decrease the setting value

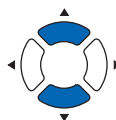

Supplement

- Digits of settings can be changed by pressing the [SLOW] key.
- Setting range is 0.0 mm to 920.0 mm.

10 Confirm the setting and press the [ESC] key (PREVIOUS).

▶ MARK DISTANCE is selected and it will return to MARK DISTANCE screen.

11 Confirm the setting and press the [ENTER] key (SET).

▶ Setting will be set, and it will return to ARMS SETTING screen (3/5).

12 Press the [PAUSE/MENU] key.

▶ It will return to default screen.

Supplement

It will return to ARMS SETTING setting screen without changing the settings when you press the [ESC] key (CANCEL).

Setting Offset Between the Registration Mark and Cutting Origin Point

The offset can be set when you want to move the cutting origin point after the registration mark is scanned.

The default offset for the registration mark is 0.0 mm on X and Y. The X and Y can be set up to the upper limit (\pm) of the cutting area.

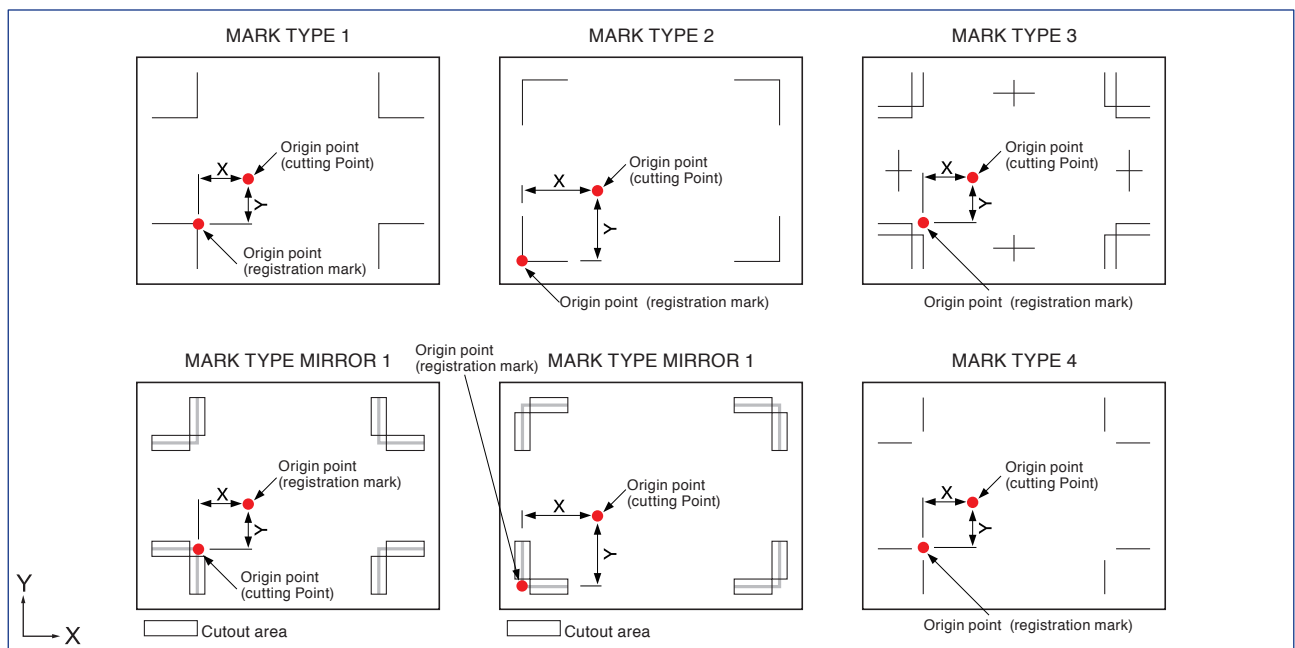

Operation

- 1 Press the [PAUSE/MENU] key.

▶ MENU screen is displayed.

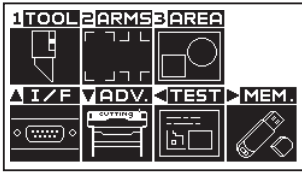

- 2 Press the [2] key (ARMS).

▶ ARMS SETTING screen (1/5) is displayed.

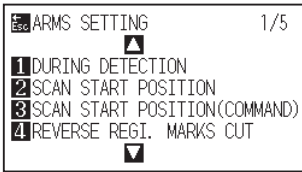

- 3 Press the POSITION (▲) key twice.

▶ ARMS SETTING screen (3/5) is displayed

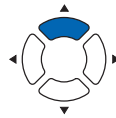
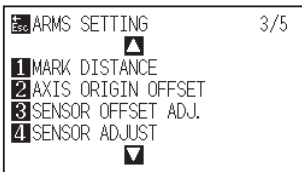

- 4 Press the [2] key (AXIS ORIGIN OFFSET).

▶ AXIS ORIGIN OFFSET screen is displayed.

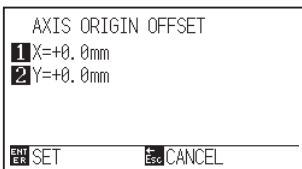

Supplement

It will return to ARMS SETTING screen (3/5) without changing the settings when you press the [ESC] key (CANCEL).

- 5 Press the [1] key (X).

▶ X AXIS setting screen is displayed.

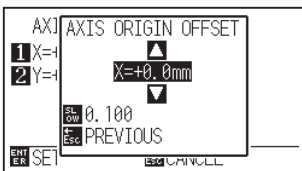

- 6 Press the POSITION (▲▼) keys and increase or decrease the setting value.

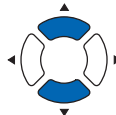

Supplement

- Digits of settings can be changed by pressing the [SLOW] key.
- Setting range is up to the upper limit (±) of the cutting area.

7 Confirm the setting and press the [ESC] key (PREVIOUS).

▶ Offset value will be selected, and it will return to AXIS ORIGIN OFFSET mode screen.

8 Press the [2] key (Y).

▶ Y AXIS setting screen is displayed.

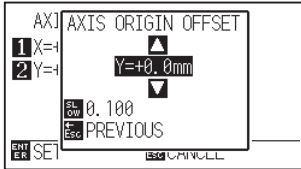

9 Press the POSITION (▲▼) keys and increase or decrease the setting value.

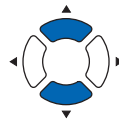

Supplement

- Digits of settings can be changed by pressing the [SLOW] key.
- Setting range is -920.0 mm to +920.0 mm.

10 Confirm the setting and press the [ESC] key (PREVIOUS).

▶ Offset value will be selected, and it will return to AXIS ORIGIN OFFSET mode screen.

11 Confirm the setting and press the [ENTER] key (SET).

▶ Setting will be set, and it will return to ARMS SETTING screen (3/5).

Supplement

It will return to ARMS SETTING setting screen without changing the settings when you press the [ESC] key (CANCEL).

12 Press the [PAUSE/MENU] key.

▶ It will return to default screen.

Adjusting for the Registration Mark Scan Position

Sensor used to detect the registration mark is located in a position away from the blade tip of the tool (pen tip). Therefore, to match the coordinate values that are scanned the registration mark to the positions that are scanned, the adjustment may be required.

If the registration mark is already marked on the media, scan that registration mark, plot another registration mark in the same position, and measure the difference between them. This difference is entered as an adjustment value.

If there is no registration mark on the media, plot a registration mark first, scan that registration mark, plot another registration mark, and measure the difference of them. This difference is entered as an adjustment value. When using media and tools for actual use, the adjustment accuracy will be higher.

Reference

There is a restriction on the shape (style) of the registration marks that can be scanned. See "Shape (Pattern) of Registration Mark".

Adjust After Plotting the Adjustment Registration Mark

This section describes the steps to plot the registration mark.

Registration mark is to be plotted if there is no registration mark on the media to adjust the registration mark scan position. Subsequently, it continues to "Adjusting the registration mark position".

Reference

Proceed to "Setting the Position Using ARMS" without plotting the registration mark if the registration mark is already drawn on the media.

Operation

- 1 Load white media.
- 2 Set the water-based fiber pen on the tool holder.
- 3 Press the [PAUSE/MENU] key.
▶ MENU screen is displayed.



Supplement

See "Loading Media " for loading white media.

Supplement

See "Attaching a Tool" for setting the water-based fiber pen. If the water-based fiber-tip pen has been scratched, then it may not scan.

4 Press the [2] key (ARMS).

▶ ARMS SETTING screen (1/5) is displayed.

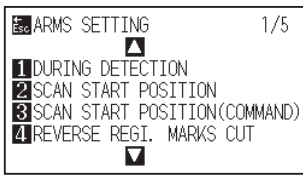

5 Press the POSITION (▲) key twice.

▶ ARMS SETTING screen (3/5) is displayed.

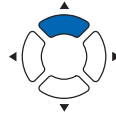
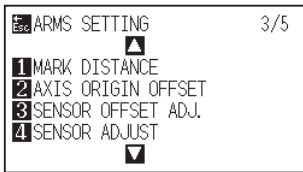

6 Press the [3] key (SENSOR OFFSET ADJ.).

▶ SENSOR OFFSET ADJ. screen is displayed.

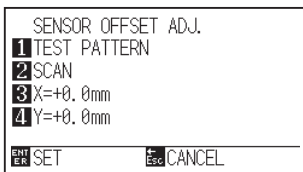

Supplement
It will return to ARMS SETTING screen (3/5) without changing the settings when you press the [ESC] key (CANCEL).

7 Press the [1] key (TEST PATTERN).

▶ Following message is displayed.

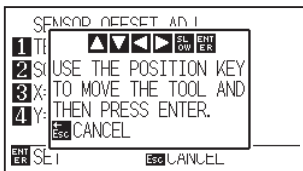

8 Press the POSITION (▲▼◀▶) keys and move the tool carriage to the position to plot the registration mark (position nothing is printed).

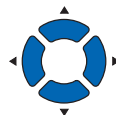

9 Press the [ENTER] key.

▶ A registration mark for adjustment is created, and then it will return to SENSOR OFFSET ADJ. screen.

Supplement
It will return to SENSOR OFFSET ADJ. screen without plotting by pressing the [4] key (CANCEL).

10 Press [2] key (SCAN). The following message is displayed.

► Following message is displayed

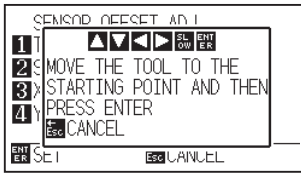

11 Confirm that the tool is at the position shown in the left image (grey square area), and press the [ENTER] key.

► It will scan the registration mark, and then plot the registration mark for comparison. It will return to SENSOR OFFSET ADJ. screen once the plotting is completed

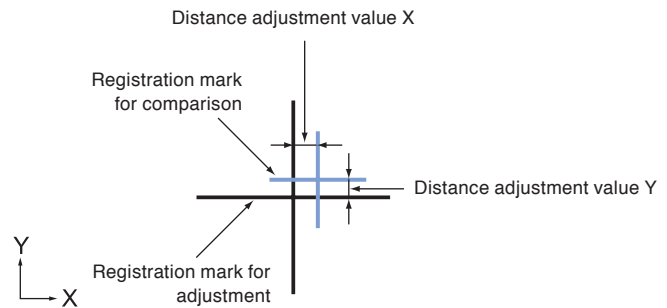
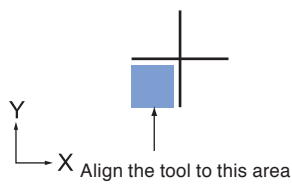

12 Using the registration mark for adjustment plotted in step 9, measure the distance of how much the registration mark for comparison needs to be moved so both will overlap, and record the value. As an example, in the figure above, it needs to move in negative directions for both X and Y directions, so both of the adjustment values will be negative values.

Supplement

Position of the registration mark is measured at the center of the line.

13 Press the [3] key (X).

► SENSOR OFFSET ADJ. X screen is displayed.

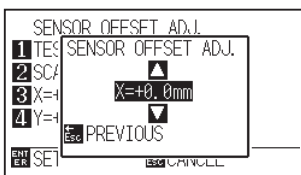

14 Press the POSITION (▲▼) keys and increase or decrease the setting value. Set the X value measured in step 12.

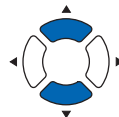

Supplement

Setting range is -2.0 mm to +2.0 mm.

15 Confirm the setting and press the [ESC] key (PREVIOUS).

► SENSOR OFFSET ADJ. is selected and it will return to SENSOR OFFSET ADJ. screen.

16 Press the [4] key (Y).

▶ SENSOR OFFSET ADJ. Y screen is displayed.

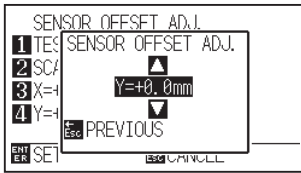

17 Press the [ESC] key and increase or decrease the setting value. Set the Y value measured in step 12.

Supplement

Setting range is -2.0 mm to +2.0 mm.

18 Confirm the setting and press the [ESC] key (PREVIOUS).

▶ SENSOR OFFSET is selected and it will return to SENSOR OFFSET ADJ. screen.

19 Confirm the setting and press the [ENTER] key (SET).

▶ Setting will be set, and it will return to ARMS SETTING screen (3/5).

Supplement

It will return to ARMS SETTING screen (3/5) without changing the settings when you press the [ESC] key (CANCEL).

20 Press the [PAUSE/MENU] key.

▶ It will return to the default screen.

Sense the Registration Mark for Adjustment on the Media and Enter the Value

Method to enter the adjustment value, which is the difference between the scanned registration mark on the media and the cutting position, is described here.

Supplement

Plot the registration mark before going to following steps if there is no registration mark written on the media. See "Adjust After Plotting the Adjustment Registration Mark" to plot registration marks.

Operation

1 Load the media with registration mark for adjustment in the plotter.

Supplement

See "Loading Media" for loading the media.

2 Press the [PAUSE/MENU] key.

▶

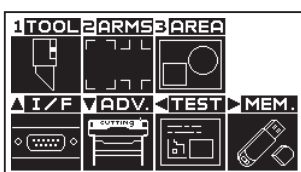

3 Press the [2] key (ARMS).

▶ ARMS SETTING screen (1/5) is displayed.

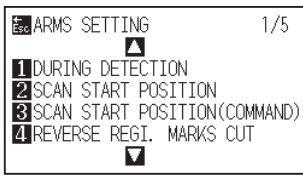

4 Press the POSITION (▲) key twice.

▶ ARMS SETTING screen (3/5) is displayed.

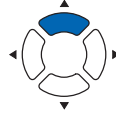
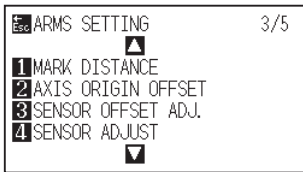

5 Press the [3] key (SENSOR OFFSET ADJ.).

▶ SENSOR OFFSET ADJ. screen is displayed.

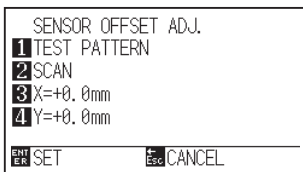

Supplement

It will return to ARMS SETTING screen (3/5) without changing the settings when you press the [ESC] key (CANCEL).

6 Press the POSITION (▲▼◀▶) keys and move the tool carriage to the area to start scanning of the registration mark.

Registration mark scanning area

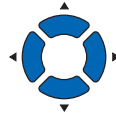
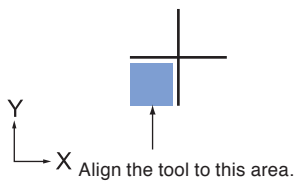

7 Confirm the position of the tool, and if it is OK, press the [ENTER] key.

▶ The registration mark for comparison is plotted after scanning the registration mark (see below). It will return to SENSOR OFFSET ADJ. screen once the plotting is completed.

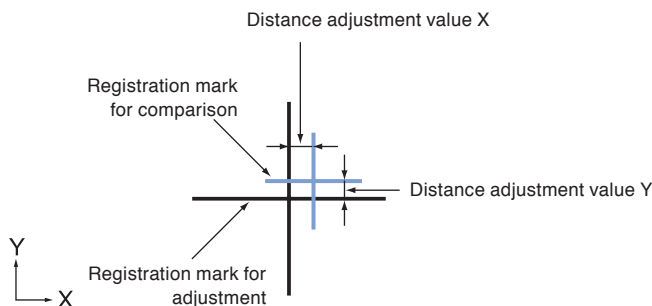

Supplement

It will return to SENSOR OFFSET ADJ. screen without plotting when you press the [ESC] key (CANCEL).

- 8 Using the scanned registration mark for adjusting, measure the distance of how much the registration mark for comparison needs to be moved so both will overlap, and record the value. As an example, in the figure above, it needs to move in negative directions for both X and Y directions, so both of the adjustment values will be a negative values.

Supplement

Position of the registration mark is measured at the center of the line.

- 9 Press the [3] key (X).

▶ SENSOR OFFSET ADJ. X screen is displayed.

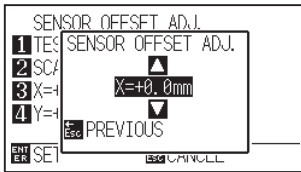

- 10 Press the POSITION (▲▼) keys and increase or decrease the setting value.

Set the X value measured in step 12.

Supplement

Setting range is -2.0 mm to +2.0 mm.

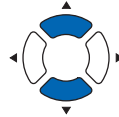

- 11 Confirm the setting and press the [ESC] key (PREVIOUS).

▶ SENSOR OFFSET ADJ. is selected and it will return to SENSOR OFFSET ADJ. screen.

- 12 Press the [4] key (Y).

▶ SENSOR OFFSET ADJ. Y screen is displayed.

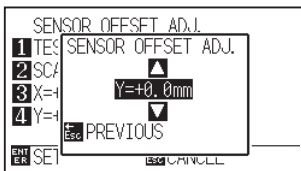

- 13 Press the POSITION (▲▼) keys and increase or decrease the setting value.

Set the Y value measured in step 12.

Supplement

Setting range is -2.0 mm to +2.0 mm.

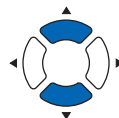

- 14 Confirm the setting and press the [ESC] key (PREVIOUS).

▶ SENSOR OFFSET is selected and it will return to SENSOR OFFSET ADJ. screen.

- 15 Confirm the setting and press the [ENTER] key (SET).
 - ▶ Setting will be set, and it will return to ARMS SETTING screen (3/5).
- 16 Press the [PAUSE/MENU] key.
 - ▶ It will return to the default screen.

Supplement

It will return to ARMS SETTING screen (3/5) without plotting when you press the [ESC] key (CANCEL).

Adjusting the Sensor Level

Scan level (threshold value between the media background color and registration mark lines) of the sensor scanning the registration mark is automatically adjusted.

Sensor is adjusted to scan the registration mark written in black lines on white background. Readjust the scan level of the sensor depending on the color and gloss of the media.

If it is hard to adjust the level automatically due to media surface characteristics, adjust the scan level of the sensor manually.

Operation

- 1 Level adjustment patterns can be printed on media that uses the patterns included on the attached DVD, or set to media with level adjustment patterns.

Level adjustment pattern

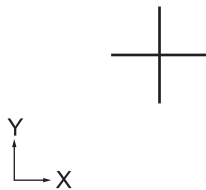

- 2 Press the [PAUSE/MENU] key.
 - ▶ MENU screen is displayed.



- 3 Press the [2] key (ARMS).
 - ▶ ARMS SETTING screen (1/5) is displayed.

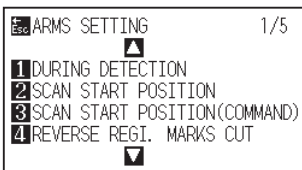

Supplement

- See "Loading Media" for setting the media.
- Standard registration mark patterns are in the [ARMS Test Files] folder on the attached DVD.

Registration Mark	File format	File name
MARK TYPE 1	pdf	ARMStest_type1.pdf
	eps	ARMStest_type1.eps
MARK TYPE 2	pdf	ARMStest_type2.pdf
	eps	ARMStest_type2.eps

- For level adjustment pattern, please use the registration mark color and registration mark line width for the media in use.

- 4 Press the POSITION (▲) key twice.
 ▶ ARMS SETTING screen (3/5) is displayed.

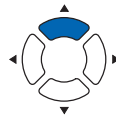
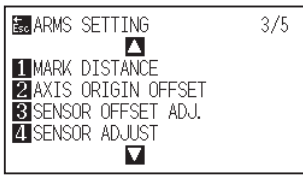

- 5 Press the [4] key (SENSOR ADJUST).
 ▶ SENSOR ADJUST screen is displayed.

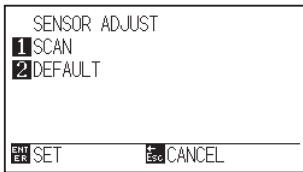

Supplement

It will return to ARMS SETTING screen (3/5) without changing the settings when you press the [ESC] key (CANCEL).

- 6 Press the [1] key (SCAN).
 ▶ The following message is displayed.

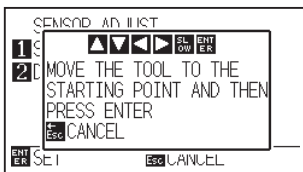

Supplement

It will return to ARMS SETTING screen (3/5) after setting the sensor level to default when you press the [2] key (DEFAULT).

- 7 Press the POSITION (▲▼◀▶) keys and move the tool carriage to the area to start scanning of the registration mark.

Registration mark scan area

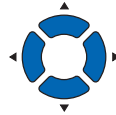
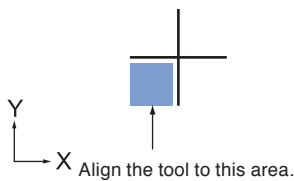

- 8 Confirm the position of the tool, and if it is OK, press the [ENTER] key.
 ▶ Registration mark is scanned, and sensor level is adjusted. It will return to ARMS SETTING screen (3/5) once the adjustment is completed.

Supplement

- It will return to SENSOR ADJUST screen without changing the settings when you press the [ESC] key (CANCEL).
- It may not scan correctly even after the adjustment depending on the condition of the media. See "Manual Position Adjust" if the sensing does not complete properly.

- 9 Press the [PAUSE/MENU] key
 ▶ It will return to default screen.

Setting the registration mark automatic sensing

When setting the registration mark automatic sensing to on, the following operations will be performed.

Set the registration mark mode to ARMS and during the start of the automatic reading when the current position of the tool is close to the first point (Point 1), by pressing the [ENTER] key* without moving to the sensing start position of tool, the registration mark position will be automatically retrieved.

* "Please move the tool and press ENTER" message will be displayed. Either press the [ENTER] key at that tool position, or move the tool to a position close to the registration mark sensing start position and press the [ENTER] key.

Supplement

If the current position of the tool is distanced from the first registration mark, sensing may take a long time, and errors due to not finding anything may occur.

When setting to off, the operation above is not performed.

Operation

- 1 Press the [PAUSE/MENU] key.

▶ MENU screen is displayed.



- 2 Press the [2] key (ARMS).

▶ ARMS SETTING setting screen (1/5) is displayed.

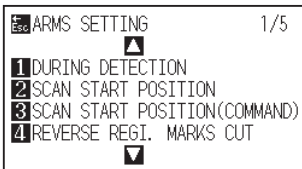

- 3 Press the POSITION (▼) key twice.

▶ ARMS SETTING screen (4/5) is displayed.

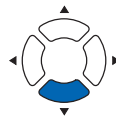
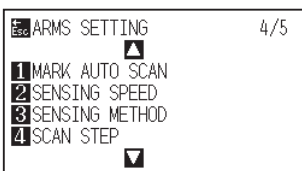

- 4 Press the [1] key (MARK AUTO SCAN).

▶ MARK AUTO SCAN setting screen is displayed.

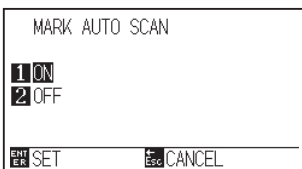

Supplement

It will return to ARMS SETTING screen (4/5) without changing the settings when you press the [ESC] key (CANCEL).

- 5 Press the [1] key (ON) or the [2] key (OFF).
- 6 Confirm the setting and press the [ENTER] key (SET).
 - ▶ Setting will be set, and it will return to ARMS SETTING screen (4/5).
- 7 Press the [PAUSE/MENU] key.
 - ▶ It will return to the default screen.

Supplement

It will return to ARMS SETTING screen (4/5) without changing the settings when you press the [ESC] key (CANCEL).

Setting Speed of the Registration Mark Scan

Speed of the tool carriage and media to scan the registration mark is set.

It may not scan the registration marks or the difference may become large when the speed is too high, but the cutting time becomes longer when the speed is too slow. Adjust the setting value considering the balance.

If the registration marks are not scanned or the error is large, it might be able to improve by setting to a slow value.

Operation

- 1 Press the [PAUSE/MENU] key.

▶ MENU screen is displayed.



- 2 Press the [2] key (ARMS).

▶ ARMS SETTING screen (1/5) is displayed.

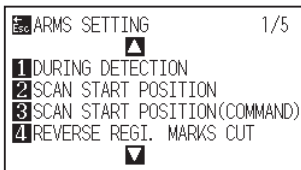

- 3 Press the POSITION (▲) key twice.

▶ ARMS SETTING screen (4/5) is displayed.

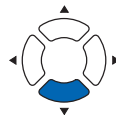
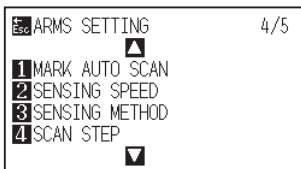

4 Press the [2] key (SENSING SPEED).

▶ SENSING SPEED screen is displayed.

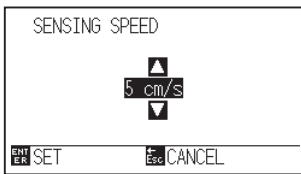

Supplement

It will return to ARMS SETTING screen (4/5) without changing the settings when you press the [ESC] key (CANCEL).

5 Press the POSITION (▲▼) keys and increase or decrease the setting value.

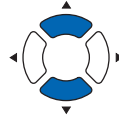

Supplement

Setting range is 1 to 10 (cm/s).

6 Confirm the setting and press the [ENTER] key (SET).

▶ Setting will be set, and it will return to ARMS SETTING screen (4/5).

Supplement

It will return to ARMS SETTING screen (4/5) without changing the settings when you press the [ESC] key (CANCEL).

7 Press the [PAUSE/MENU] key.

▶ It will return to the default screen.

Setting the Scanning Method When Registration Marks are Scanned ("ISM"/"NORMAL")

You can set the scanning method when the registration marks are scanned.

It is normally set to "NORMAL", but the registration marks cannot be scanned when the following media are used. In that case, it will be improved by setting to "ISM".

- Media that the surface is laminated
- Media with hairlines
- Media other than white, or glossy media

* ISM (Intelligent Scan Mode) is a function to increase the scanning accuracy of the registration mark.

Operation

1 Press the [PAUSE/MENU] key.

▶ MENU screen is displayed.

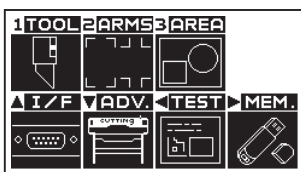

2 Press the [2] key (ARMS).

▶ ARMS SETTING screen (1/5) is displayed.

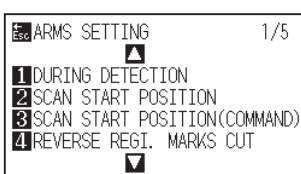

- 3 Press the POSITION (▲) key twice.
▶ ARMS SETTING screen (4/5) is displayed.

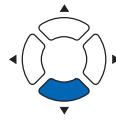
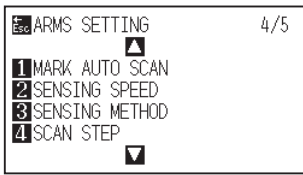

- 4 Press the [3] key (SENSING METHOD).
▶ SENSING METHOD screen is displayed.

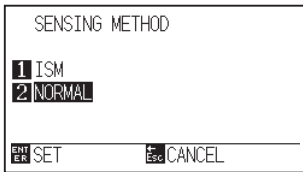

Supplement

It will return to ARMS SETTING screen (4/5) without changing the settings when you press the [ESC] key (CANCEL).

- 5 Press the [1] key (ISM) or the [2] key (NORMAL).
▶ The SENSING METHOD is selected.

Supplement

It will return to ARMS SETTING setting screen without changing the settings when you press the [ESC] key (PREVIOUS).

- 6 Confirm the setting and press the [ENTER] key (SET).
▶ Setting will be set, and it will return to ARMS SETTING screen (4/5).

- 7 Press the [PAUSE/MENU] key.
▶ It will return to the default screen.

Setting Scan Step When Registration Marks Are Scanned

If the line segments are fine, the registration marks may not be sensed even when the slowest registration mark sensing speed has been set. If the interval has been set to 0-step, the registration marks are sensed through sampling during movement. If the interval is set to 5 to 15 μm , the registration marks are sensed at the specified interval.

It is valid only when the TYPE 3 or TYPE 4 of the registration mark is specified.

Operation

- 1 Press the [PAUSE/MENU] key.
▶ MENU screen is displayed.

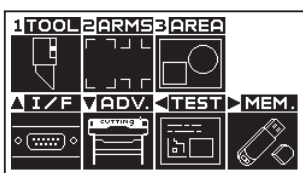

2 Press the [2] key (ARMS).

▶ ARMS SETTING screen (1/5) is displayed.

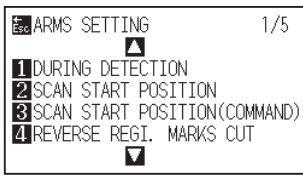

3 Press the POSITION (▼) key three.

▶ ARMS SETTING screen (4/5) is displayed

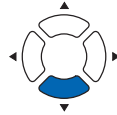
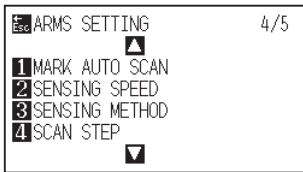

4 Press the [4] key (SCAN STEP).

▶ SCAN STEP screen is displayed.

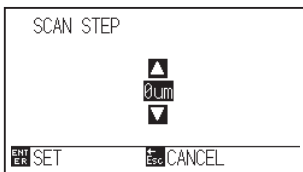

Supplement

It will return to ARMS SETTING screen (4/5) without changing the settings when you press the [ESC] key (CANCEL).

5 Press the POSITION (▲▼) keys and increase or decrease the setting value.

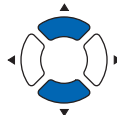

Supplement

Setting range is 0 , 5, 10, 15 (μm).

6 Confirm the setting and press the [ENTER] key (SET).

▶ Setting will be set, and it will return to ARMS SETTING screen (4/5).

Supplement

It will return to ARMS SETTING screen without changing the settings when you press the [ESC] key (CANCEL).

7 Press the [PAUSE/MENU] key.

▶ It will return to the default screen.

Manually Adjusting the Sensor Level (Threshold Value)

The sensing level (threshold value between the media background color and registration mark lines) of the sensor scanning the registration mark can also be manually set.

Sensor is adjusted to scan the registration mark written in black lines on white background as the default condition. The sensing level of the sensor may need to be adjusted for registration marks printed in color and the finish (gloss/matte) of the media.

Operation

- 1 Press the [PAUSE/MENU] key.

▶ MENU screen is displayed.



- 2 Press the [2] key (ARMS).

▶ ARMS SETTING screen (1/5) is displayed.

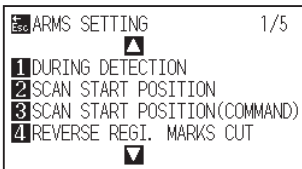

- 3 Press the POSITION (▼) key.

▶ ARMS SETTING screen (5/5) is displayed.

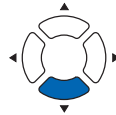
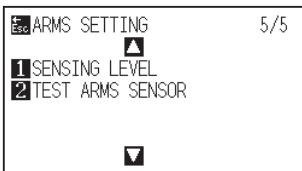

- 4 Press the [1] key (SENSING LEVEL).

▶ SENSING LEVEL screen is displayed.

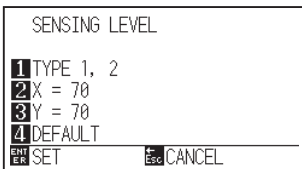

- 5 Press the [1] key (TYPE 1, 2).

▶ REGISTRAION MARK TYPE screen is displayed.

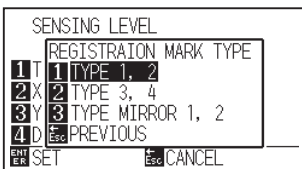

Supplement

- It will return to ARMS SETTING screen (5/5) without changing the settings when you press the [ESC] key (CANCEL).
- The SENSING LEVEL is used to specify what should be the percent threshold for the difference in each signal level when the media background color and registration marks are sensed. Setting range is 30 to 90 (%).
- The X is set to the SENSING LEVEL to sense the registration marks when moving in the X direction. The Y is set to the SENSING LEVEL to sense the registration marks when moving in the Y direction.
- Press the [4] key (DEFAULT) to return the SENSING LEVEL to the initial settings.

6 Press the [1] key (TYPE 1, 2), the [2] key (TYPE 3, 4) or the [3] key (TYPE MIRROR 1, 2).

▶ The registration mark pattern is selected.

7 Press the [1] key (X).

▶ SENSING LEVEL (SENSING LEVEL X) screen is displayed.

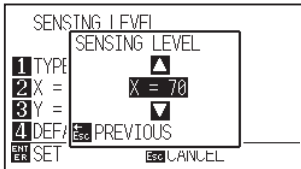

8 Press the POSITION (▲▼) keys and increase or decrease the setting value.

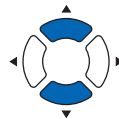

9 Confirm the settings and press the [ENTER] key key (PREVIOUS).

▶ The SENSING LEVEL is selected and it will return to the SENSING LEVE screen.

10 Press the [2] key (Y).

▶ SENSING LEVEL (SENSING LEVEL Y) screen is displayed.

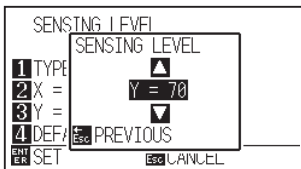

11 Press the POSITION(▲▼) keys and increase or decrease the setting value.

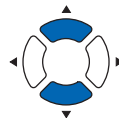

12 Confirm the settings and press the [ENTER] key key (PREVIOUS).

▶ The SENSING LEVEL is selected and it will return to the SENSING LEVE screen.

13 Confirm the setting and press the [ENTER] key (SET).

▶ Setting will be set, and it will return to ARMS SETTING screen (5/5).

14 Press the [PAUSE/MENU] key.

▶ It will return to the default screen.

Supplement

It will return to ARMS SETTING setting screen without changing the settings when you press the [ESC] key (PREVIOUS).

Supplement

- Setting range is 30 to 90.
- The level to scan the horizontal line of the registration mark is Y and the level to scan the vertical line is X.
- Raising the numerical value in the following situations will allow you to sense the registration marks.
 - When the media and registration mark colors are similar.
 - When you pass over the registration mark point.
- Lowering the numerical value in the following situations will allow you to sense the registration marks.
 - When you sense a point where there is no registration mark.
 - When folds or stains on the media surface are sensed.

Supplement

Setting range is 30 to 90.

Supplement

It will return to ARMS SETTING setting screen without changing the settings when you press the [ESC] key (PREVIOUS).

Test the Registration Mark Sensor

If there still is a difference in the cutting, even after performing an adjustment using the registration mark, it is possible to check if there is a problem with the registration mark itself or the application by evaluating the position of the registration mark plotted and sensed only using the plotter.

CAUTION

This function performs cutting after the registration mark is scanned. If a cutter is used as the tool, it may harm the plotter.

Operation

- 1 Print the standard registration mark in the attached DVD.

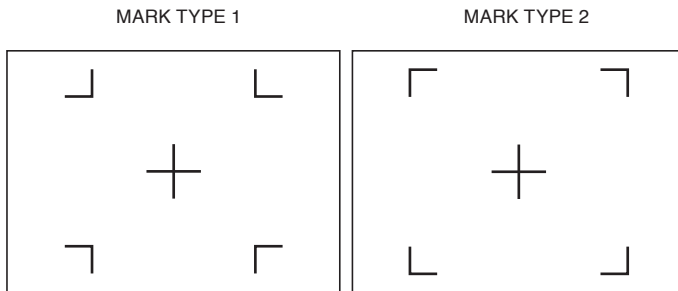

Supplement

- Print the "Test Pattern 1" to test MARK TYPE 1, and "Test Pattern 2" to test MARK TYPE 2.
- Standard registration mark is inside the "ARMS Test Files" folder of the attached DVD.

Registration Mark	File format	File name
MARK TYPE 1	pdf	ARMStest_type1.pdf
	eps	ARMStest_type1.eps
MARK TYPE 2	pdf	ARMStest_type2.pdf
	eps	ARMStest_type2.eps

- 2 Load the printed media onto the plotter.

- 3 Press the [PAUSE/MENU] key.

▶ MENU screen is displayed.



- 4 Press the [2] key (ARMS).

▶ ARMS SETTING screen (1/5) is displayed.

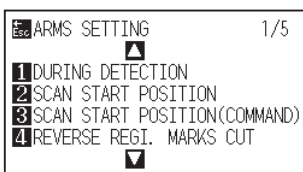

- 5 Press the POSITION (▼) key.

▶ ARMS SETTING screen (5/5) is displayed.

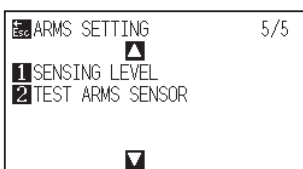

6 Press the [2] key (TEST ARMS SENSOR).

▶ TEST ARMS SENSOR screen is displayed.

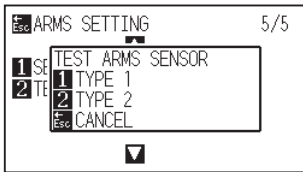

Supplement

It will return to TOOL setting screen (5/5) without changing the settings when you press the [ESC] key (CANCEL).

7 Press either the [1] key (TYPE 1) or the [2] key (TYPE 2) depending on the type of the registration mark to be used.

▶ The following message is displayed.

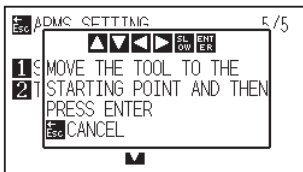

Supplement

It will return to TEST ARMS SENSOR screen without changing the settings when you press the [ESC] key (CANCEL).

8 Move the tool to the position to start scanning of the registration mark by pressing the POSITION (▲▼◀▶) keys.

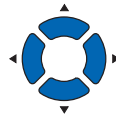

Registration mark scanning area

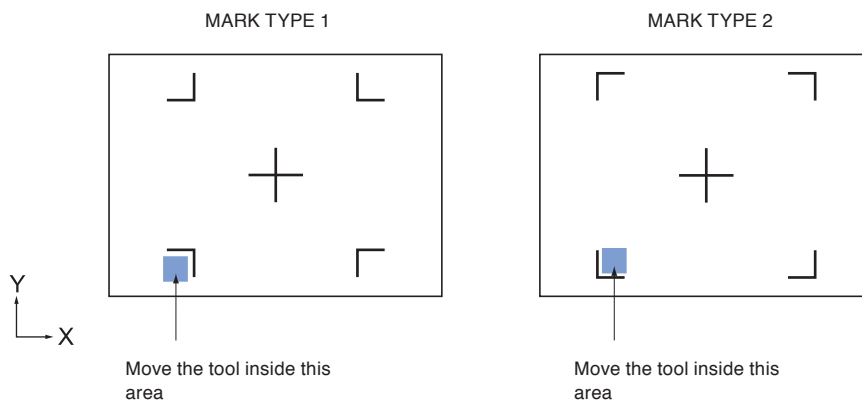

9 Confirm the position of the tool and press the [ENTER] key.

▶ The plotter will automatically sense the registration mark and cut the peak of each registration marks

Supplement

Following error is displayed when the registration mark was not scanned properly.

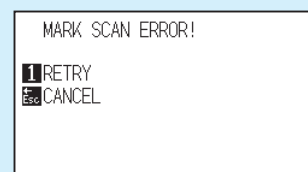

Press the [1] key (SCAN AGAIN) to scan again, or the [ESC] key (CANCEL) to exit.

10 Confirm the cutting result.

▶ See "Adjusting for the Registration Mark Scan Position" and adjust if the cutting position is shifted. See "Adjusting the Sensor Level" and adjust if the registration mark cannot be scanned.

5.3 Setting the Position Using ARMS

This section describes the method to adjust the position with the operation from control panel using ARMS.

There are following 3 methods depending on the number of registration marks scanned. In general, the adjustment becomes more accurate with more registration marks scanned, but it will take longer to adjust.

- Adjust with 2POINTS
- Adjust with 3POINTS
- Adjust with 4POINTS
- Adjust Automatically
- Adjust Manually

Adjust with 2POINTS

2POINTS adjustment scans 2 registration marks aligned in the media transportation direction, where the adjustment is done measuring the tilting of the axis and the distance between the registration marks. This adjustment is 1 axis adjustment (tilt adjustment).

When the set media is inclined with respect to the X-direction as shown in the following figure, the actually measured position of the registration mark is shifted from the original position. Comparing these coordinates, the inclination and the distance can be adjusted.

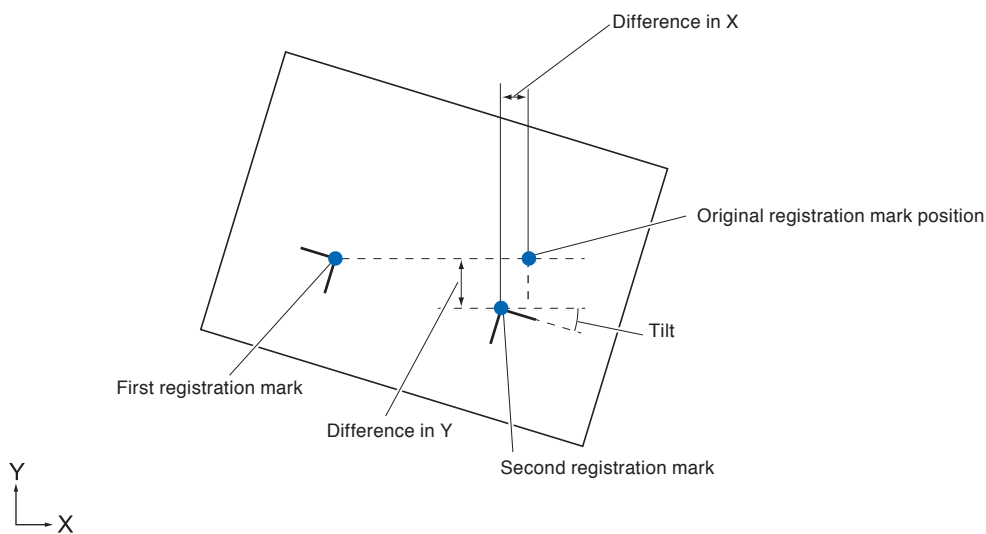

Operation

- 1 Load the media with registration marks (2POINTS) plotted.
- 2 Set the MARK SCAN MODE to ARMS, and POINTS to 2POINTS.
(See "Setting MARK SCAN Mode and Numbers".)
- 3 Set the shape and size of the registration mark, mark distance, distance adjust mode, offset, paper-weight, sensor level, scan position adjustment, etc., as needed.
(See "Setting Shape (Pattern) of Registration Mark".)

Supplement

See "Loading Media (Paper or Marking Film)" for loading the media.

Supplement

It is not necessary to set the MARK DISTANCE when it is adjusted manually.

(See “Setting Registration Mark Size”.)

(See “Setting Mark Distance”.)

(See “Setting Distance Adjustment Between the Registration Marks”.)

(See “Setting Offset Between the Registration Mark and Cutting Origin Points”.)

(See “Adjusting the Sensor Level”.)

(See “Manually Adjusting the Sensor Level (Threshold Value)”.)

4 Press the [PAUSE/MENU] key.

▶ MENU screen is displayed.

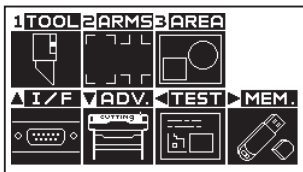

5 Press the [2] key (ARMS).

▶ ARMS SETTING screen (1/5) is displayed.

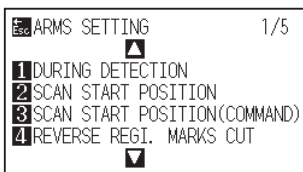

Steps are different from here depending if it is going to move to registration mark automatically to scan the registration mark, or if it is going to move manually to scan. See next section.

(See “Adjust Automatically”.)

(See “Adjust Manually”.)

Adjust with 3POINTS

3POINTS adjustment scans 3 registration marks as shown below, where the adjustment is done measuring the tilting of the X and Y axes and the distance between the registration marks (horizontal and vertical directions). This adjustment is called 2 axis adjustment (tilt adjustment).

When the set media is inclined with respect to the X-direction as shown in the following figure, the actually measured position of the registration mark is shifted from the original position. Comparing these coordinates, the inclination and the distance can be adjusted.

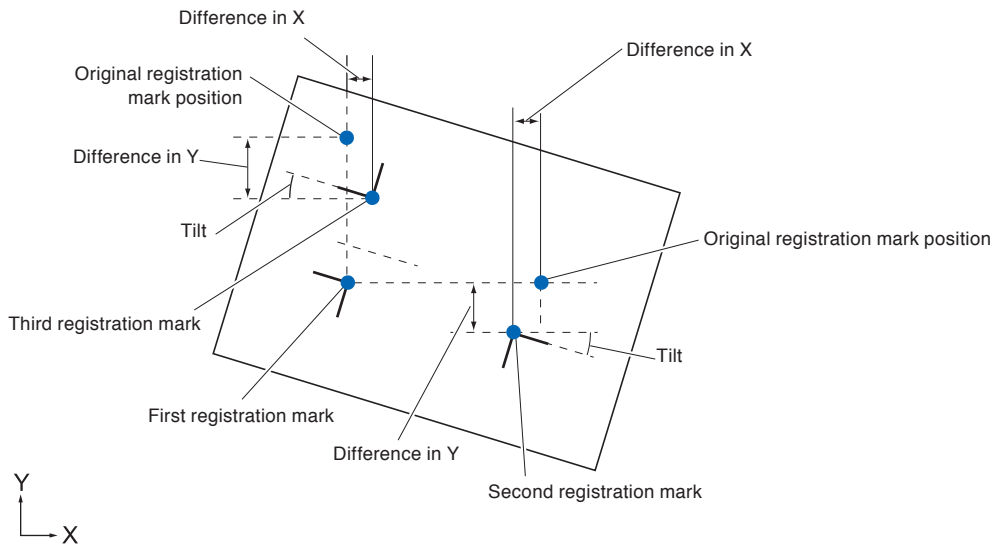

Operation

- 1 Load the media with registration marks (3POINTS) plotted.
- 2 Set the Registration Mark mode to ARMS, and the number of registration marks to 3 POINTS.
(See "Setting MARK SCAN Mode and Numbers".)
- 3 Set the shape and size of the registration mark, mark distance, distance adjust mode, offset, paper-weight, sensor level, scan position adjustment, etc., as needed.
(See "Shape (Pattern) of the Registration Mark".)
(See "Setting Registration Mark Size".)
(See "Setting Mark Distance".)
(See "Setting Distance Adjustment Between the Registration Marks".)
(See "Setting Offset Between the Registration Mark and Cutting Origin Points".)
(See "Adjusting the Sensor Level".)
(See "Manually Adjusting the Sensor Level (Threshold Value)".)
- 4 Press the [PAUSE/MENU] key.
▶ MENU screen is displayed

Supplement

See "Loading Media (Paper or Marking Film)" for loading the media.

Supplement

It is not necessary to set the MARK DISTANCE when it is adjusted manually.



5 Press the [2] key (ARMS).

▶ ARMS SETTING screen (1/5) is displayed.

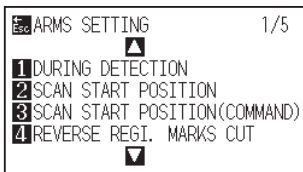

Steps are different from here depending if it is going to move to registration mark automatically to scan the registration mark, or if it is going to move manually to scan. See next section.

(See “Adjust Automatically”.)

(See “Adjust Manually”.)

Adjust with 4POINTS

4POINTS adjustment will scan 4 registration marks in the corners, where the adjustment is done measuring the tilting of the X and Y axes and the distance between each of the registration marks. It will perform 2 axes warp adjustment in addition to the 2 axes (tilt) adjustment and distance adjustment, so it can adjust more precisely than other methods.

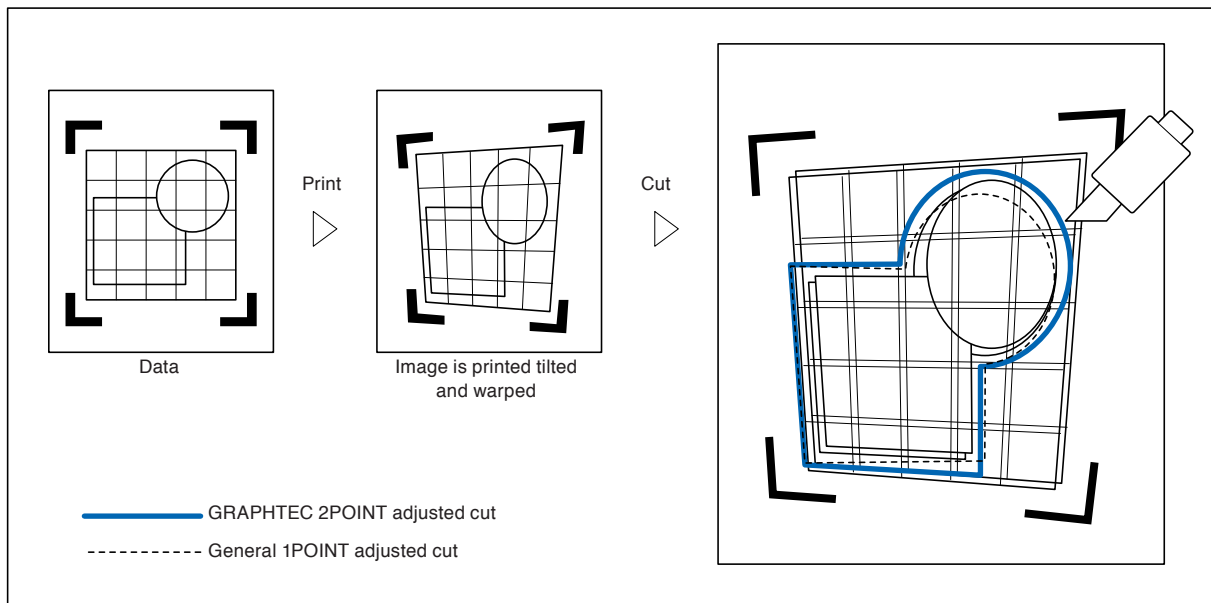

Operation

- 1 Load the media with registration marks (4POINTS) plotted.
- 2 Set the Registration Mark mode to ARMS, and the number of registration marks to 4 POINTS.
(See “Setting MARK SCAN Mode and Numbers”.)

Supplement

See "Loading Media (Paper or Marking Film)" for loading the media.

- 3 Set the shape and size of the registration mark, mark distance, distance adjust mode, offset, paper-weight, sensor level, scan position adjustment, etc., as needed.
 (See “Shape (Pattern) of the Registration Mark”.)
 (See “Setting Registration Mark Size”.)
 (See “Setting Mark Distance”.)
 (See “Setting Distance Adjustment Between the Registration Marks”.)
 (See “Setting Offset Between the Registration Mark and Cutting Origin Points”.)
 (See “Adjusting the Sensor Level”.)
 (See “Manually Adjusting the Sensor Level (Threshold Value)”.)

Supplement

It is not necessary to set the MARK DISTANCE when it is adjusted manually.

- 4 Press the [PAUSE/MENU] key.

▶ MENU screen is displayed



- 5 Press the [2] key (ARMS).

▶ ARMS SETTING screen (1/5) is displayed.

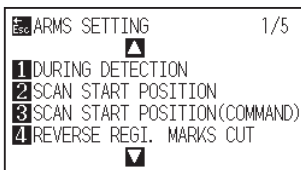

Steps are different from here depending if it is going to move to registration mark automatically to scan the registration mark, or if it is going to move manually to scan. See next section.

(See “Adjust Automatically”.)

(See “Adjust Manually”.)

Adjust Automatically

This section describes the operation to adjust with registration mark scan by moving to registration mark automatically after setting the ARMS mode and POINTS.

Operation

- 1 Press the [1] key (AUTO READ MARKS) in the ARMS SETTING screen (1/5).

▶ (See "Adjust Automatically".)

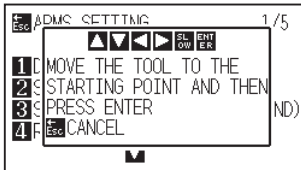

- 2 Press the POSITION (▲▼◀▶) keys and move the tool carriage to the area to start scanning of the registration mark.

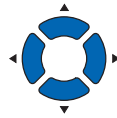

Registration mark scan area

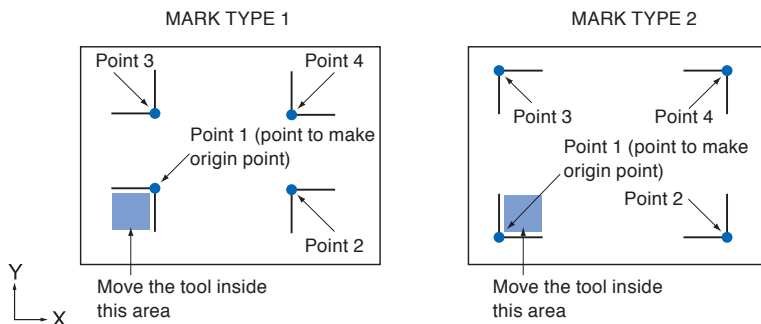

- 3 Confirm the position of the tool, and if it is OK, press the [ENTER] key (SET).

▶ Registration marks are scanned automatically. DISTANCE entry screen is displayed once the scanning is completed.

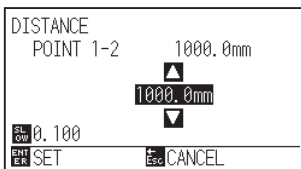

- 4 Press the POSITION (▲▼) keys and increase or decrease the setting value.

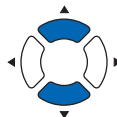

Supplement

See "Adjust Manually" if you are moving manually to registration mark for scanning.

Supplement

- Press the [2] key (ARMS) in the MENU screen if it is not ARMS SETTING screen.
- Set the "AUTO" of "SCAN START POSITION" to ON.

Supplement

Left figure is for 4POINTS. Size and position of the registration scan start area is same for 2POINTS or 3POINTS.

Supplement

- Scan the registration marks in accordance with the setting of the MARK DISTANCE (see "Setting Mark Distance").
- It will return to default screen without scanning when you press the [ESC] key (CANCEL).

Supplement

- Measured distance is displayed in the top line in the DISTANCE input screen. Input value (initially same as measured value) is displayed under that.
- If the input value is not changed, it will assume that there is no difference between the measured distance and the distance in the data.
- Digits of settings can be changed by pressing the [SLOW] key.

5 Confirm the setting and press the [ENTER] key (SET).

- ▶ Adjustment by scanning the registration mark is completed, and it will return to default screen.

Supplement

- It will return to default screen without changing the settings when you press the [ESC] key (CANCEL).
- Distance input screen for point 3 is displayed if it is set to 3POINTS or more, so repeat steps 4 and 5 to set.

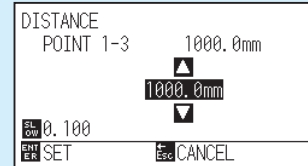

Adjust Manually

This section describes the operation to adjust with registration mark scan by moving to registration mark manually after setting the ARMS mode and POINTS.

Operation

1 Press the [2] key (MANUAL READ MARKS) in the ARMS SETTING screen (1/5).

- ▶ SCAN START POSITION screen is displayed.

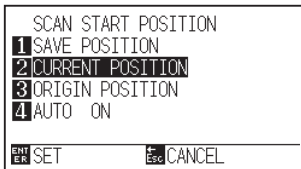

2 Press the [4] key (AUTO).

- ▶ AUTO SETING screen is displayed.

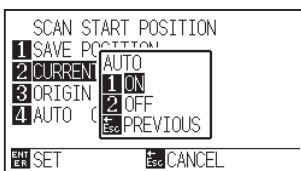

3 Press the [2] key (OFF).

- ▶ SCAN START POSITION screen is displayed.

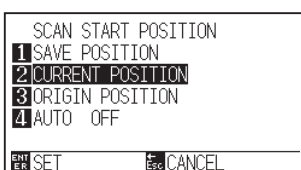

Supplement

See "Adjust Automatically" if you are moving automatically to registration mark for scanning.

Supplement

Press the [2] key (ARMS) in the MENU screen if it is not ARMS SETTING screen.

4 Press the [ENTER] key (SET)

▶ ARMS SETTING screen (1/5) is displayed.

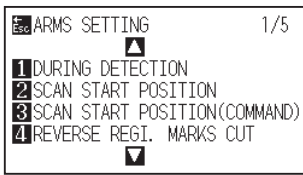

5 Press the [1] key (DURING DETECTION) in the ARMS SETTING screen (1/5).

▶ The following message is displayed.

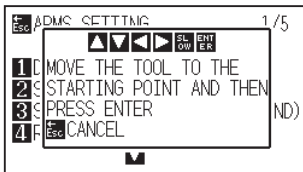

6 Press the POSITION (▲▼◀▶) keys and move the tool carriage to the area to start scanning of the registration mark.

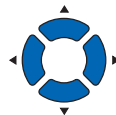

Registration mark scan area

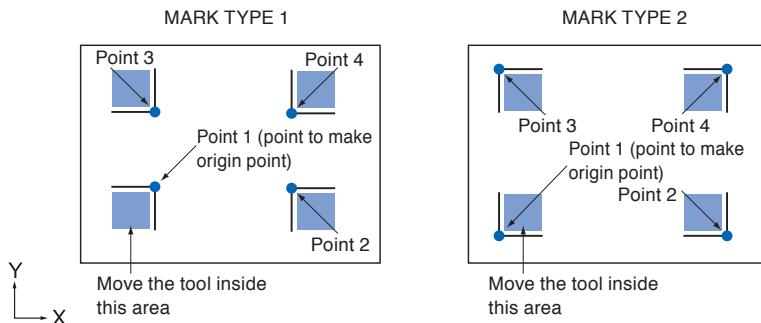

Supplement

Left figure is for 4POINTS. Size and position of the registration scan start area is same for 2POINTS or 3POINTS.

7 Confirm the position of the tool, and if it is OK, press the [ENTER] key.

▶ Registration marks are scanned. A message to move to next registration mark position is displayed once the scanning is completed. Repeat steps 4 and 5 following the message in that case.

▶ DISTANCE entry screen is displayed once the registration mark is scanned.

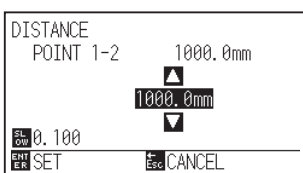

Supplement

- The registration marks are scanned in accordance with the settings of the Mark Distance.
- It will return to Default screen without scanning when you press the [ESC] key (CANCEL).

- 8 Press the POSITION (▲▼) keys and increase or decrease the setting value.

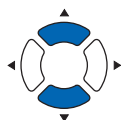

Supplement

- Measured distance is displayed in the top line in the DISTANCE input screen. Input value (initially same as measured value) is displayed under that.
- If the input value is not changed, it will assume that there is no difference between the measured distance and the distance in the data.
- Digits of settings can be changed by pressing the [SLOW] key.

- 9 Confirm the setting and press the [ENTER] key (SET).

- ▶ Adjustment by scanning the registration mark is completed, and it will return to default screen.

Supplement

- It will return to default screen without changing the settings when you press the [ESC] key (CANCEL).
- Distance input screen for point 3 is displayed if it is set to 3POINTS or more, so repeat steps 8 and 9 to set.

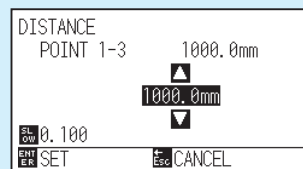

Chapter 6: Manual Position Adjust

Here, we will explain how to match up points while manually confirming the media and tool (cutter pen or plotting pen) points.

The ARMS function can be used for accurately matching up points.

PRODUCT SUMMARY

6.1 *Outline of Manual Position Adjust*

6.2 *Manual Position Adjust*

6.1 Outline of Manual Position Adjust

With manual position adjust, tilt of the axes are adjusted using the 2POINTS, 3POINTS, or 4POINTS adjustment marks (grits or registration marks) as a standard. The distance between each points can also be entered to adjust the distance.

Move the tip of each tool to the appropriate point.

Use the media with prints (adjustment marks such as grits or registration marks) necessary to get XY axes and origin point.

Setting of MARK SCAN MODE and Number of Adjustment Marks

To perform the AXIS ALIGNMENT, set the MARK SCAN MODE to "AXIS ALIGNMENT".

Select the number of the registration marks (adjustment marks) from 2POINTS, 3POINTS, or 4POINTS when the MARK SCAN MODE is set to "AXIS ALIGNMENT". Position of each adjustment marks are as following.

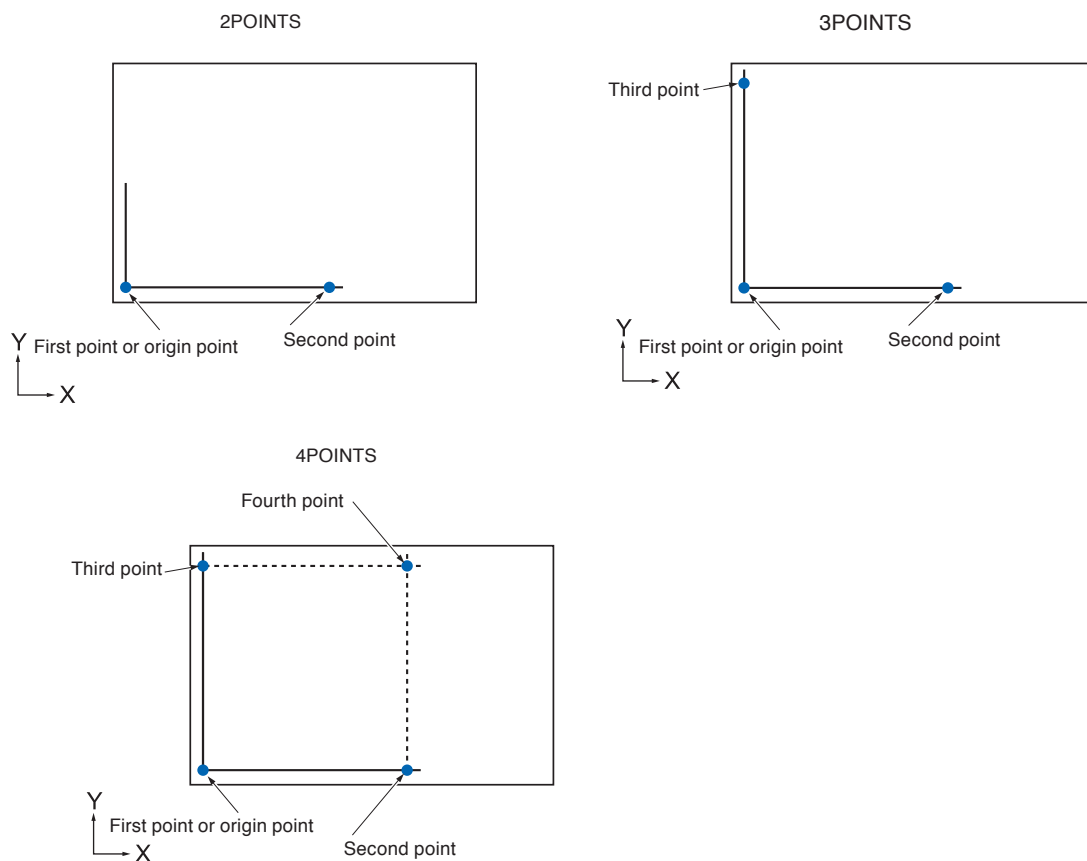

6.2 Manual Position Adjust

Method of manual position adjust is described here.

Supplement

- Adjustment will be cleared if the following is done after setting the adjustment.
 - Set new origin point.
 - Set rotation or mirror. (Set the rotate or mirror prior to the axis adjustment)
- When the inclination of the axis is too large when setting the first and second point, the first and third point, the third and fourth point, or the second and fourth point, "Angle adjustment error, please reset" will be displayed. After setting the media so as to make the inclination small, please perform adjustment operations.
- Axis adjustment will be cleared when point 1 and point 2 is set to same point.

Operation

- 1 Load the media with adjustment mark in the plotter
(Refer to the "Loading the Media")
- 2 Set a cutter plunger or a pen in the tool holder.
- 3 Press the [PAUSE/MENU] key.

▶ MENU screen is displayed.



- 4 Press the [2] key (ARMS).

▶ ARMS SETTING screen (1/5) is displayed.

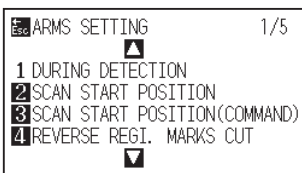

- 5 Press the POSITION (▲) key.

▶ ARMS SETTING screen (2/5) is displayed.

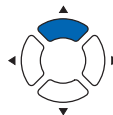
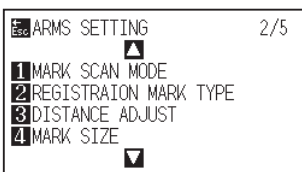

6 Press the [1] key (MARK SCAN MODE).

▶ MARK SCAN MODE setting screen is displayed.

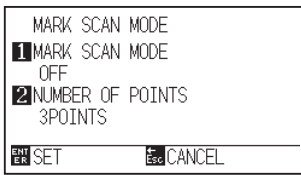

7 Press the [1] key (MARK SCAN MODE).

▶ MARK SCAN MODE setting screen is displayed.

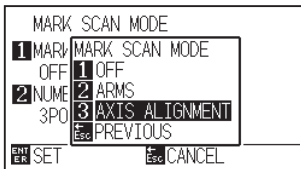

8 Press the [3] key (AXIS ALIGNMENT).

▶ MARK SCAN MODE will be selected and it will return to MARK SCAN MODE setting screen.

Supplement

It will return to MARK SCAN MODE setting screen without changing the setting when you press the [ESC] key (CANCEL).

9 Press the [2] key (NUMBER OF POINTS).

▶ NUMBER OF POINTS setting screen is displayed.

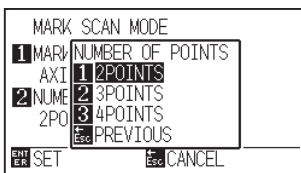

10 Press the [1] key (2POINTS), the [2] key (3POINTS), or the [3] key (4POINTS).

▶ NUMBER OF POINTS will be selected and it will return to MARK SCAN MODE setting screen.

Supplement

It will return to MARK SCAN MODE setting screen without changing the setting when you press the [ESC] key (CANCEL).

11 Confirm the setting and press the [ENTER] key (SET).

▶ Setting will be set, and it will return to ARMS SETTING screen (2/5).

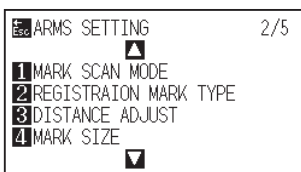

12 Press the POSITION (▼) key.

▶ ARMS SETTING screen (1/5) is displayed.

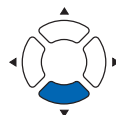
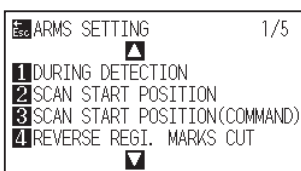

13 Press the [1] key (DURING DETECTION) in ARMS SETTING screen (1/5).

▶ Following message is displayed.

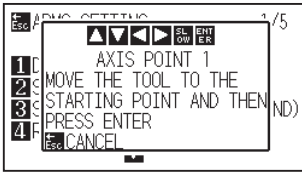

14 Press the POSITION (▲▼◀▶) key and match the tool tip to the adjustment point (adjustment registration mark).

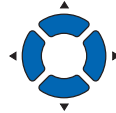

15 Confirm the position of the tool, and if it is OK, press the [ENTER] key (SET).

▶ Once all the adjustment marks are specified, DISTANCE entry screen is displayed.

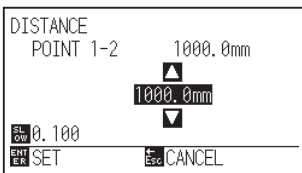

Supplement

- Repeat steps 14 and 15 if following message prompting to move to the adjustment mark is displayed.
- Number to repeat steps 14 and 15 differs depending on the specified number of the adjustment marks. Follow the message that is displayed.
- It will return to default screen without scanning when the [ESC] key (CANCEL) is pressed.

16 Press the POSITION (▲▼) keys to set the original distance on the data.

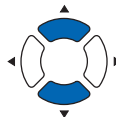

Supplement

- Measured distance is displayed in the top line in the DISTANCE input screen. Input value (initially same as measured value) is displayed under that.
- If the input value is not changed, it will assume that there is no difference between measured distance and the distance in the data.
- Digits of settings can be changed by pressing the [SLOW] key.

17 Confirm the setting and press the [ENTER] key (SET).

- ▶ The adjustments based on the registration mark scanning will be completed, and it will return to default screen.

Supplement

- It will return to default screen without changing the settings when you press the [ESC] key (CANCEL).
- DISTANCE input screen for point 3 is displayed if it is set to 3POINTS or more, so repeat steps 15 to 17 to set.

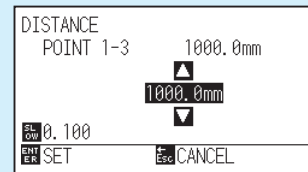

Supplement

Please refer to the following for adjustments when matching the position manually.

- 2 point matching
["Point 1" settings]→["Point 2" settings]→["Origin point of the axis adjustment" settings]→[Finish]
- 3 point matching
["Point 1" settings]→["Point 2" settings]→["Point 3" settings]→["Distance between Point 1-2" settings]→["Distance between Point 1-3" settings]→["Origin point of the axis adjustment" settings]→[Finish]
- 4 point matching
["Point 1" settings]→["Point 2" settings]→["Point 3" settings]→["Point 4" settings]→["Distance between point 1-2" settings]→["Distance between point 1-3" settings]→[Finish]

Chapter 7:

Setting Regarding Cutting Quality

There are times that ideal cutting may not be possible, such as the lines may shift, corners deform, or uncut sections occur, due to the characteristics of the media (thickness, how hard it is, etc.) or the shape of the blades, when the actual cutting is done. Adjust the moving speed and force of the tool, and the control method to prevent these problems.

This chapter describes the setting regarding the quality of the cutting.

PRODUCT SUMMARY

- 7.1 To cut the corner of thick media sharply***
- 7.2 Setting the Step Pass***
- 7.3 Setting the Offset Angle***
- 7.4 Setting the Distance Adjust***
- 7.5 Setting Cut Line***
- 7.6 Setting the Initial Blade Angle Position***
- 7.7 Settings for OFFSET FORCE***
- 7.8 Setting the Overlay Cut Function***

7.1 To cut the corner of thick media sharply

Outline of Tangential Mode

The blade needs to be facing toward the direction of cut when cutting the media. The tip of the blade is shaped as shown so the blade is facing the cutting direction even when it is cutting curved lines or corners. The tip of the blade is off from the rotation axis of the blade (CUTTER OFFSET). The blade will automatically turn and face the cutting direction when the tool carriage moves, because the blade is forced to move from the rotation center, and the blade tip gets resistance by the media.

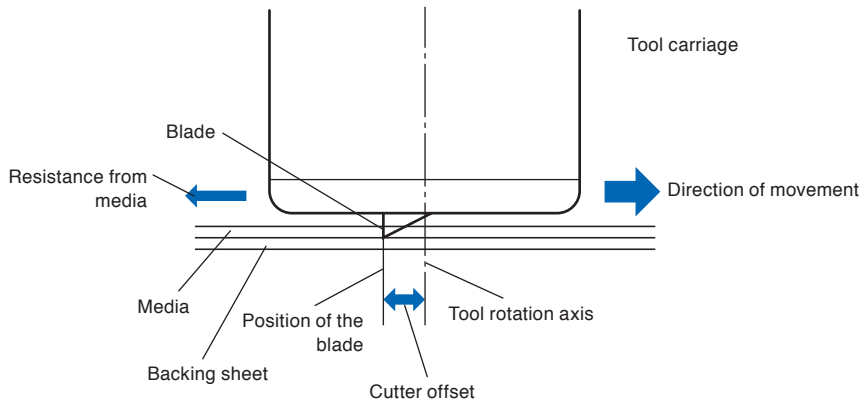

The blade tip gets sunk into the media with 0.3 mm or thicker, making the blade hard to rotate. Especially for the corners where two straight lines meet, cutting becomes very hard because it cannot rotate smoothly.

Tangential mode is a control method to precisely cut corners where two straight lines meet. (See below) With the tangential mode, the blade is advanced so it will overcut at the corners before the tool is lifted up.

Then, it will be lowered at the position slightly before the next line, and start to cut with slight overcut.

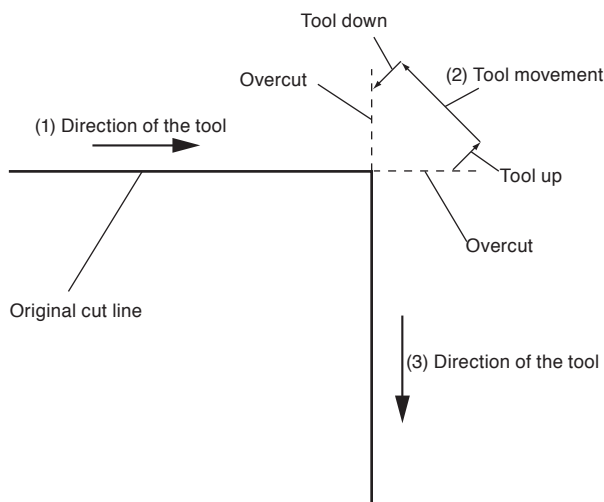

There are 2 modes for tangential mode.

Mode 1 : Overcuts the start and end points and acute-angle corners to eliminate uncut sections. In addition, the cutter blade is moved on the surface of the medium during cutting when it is rotated significantly, ensuring sharp cutting unaffected by the hardness or thickness of the media.

Mode 2 : Overcuts the start and end points only. In addition, the cutter blade is rotated on the medium surface for the start cutting position only. Mode 2 uses simpler cutter control than Mode 1, and provides a shorter cutting time.

The length of the overcuts by tangential mode can be set individually for start of the line and for end of the line.

Setting the Tangential Mode

ON/OFF and the mode of the tangential mode can be set individually for each of tool condition No. 1 to 8.

Operation

- 1 Press the [COND/TEST] key.

▶ CONDITION setting screen (1/4) is displayed.

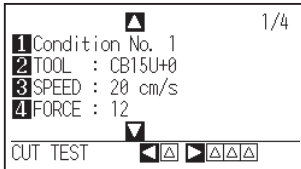

- 2 Press the POSITION (▲) key.

▶ CONDITION setting screen (2/4) is displayed.

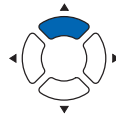
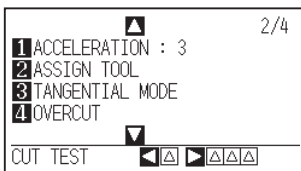

- 3 Press the [3] key (TANGENTIAL MODE).

▶ TANGENTIAL MODE setting screen is displayed.

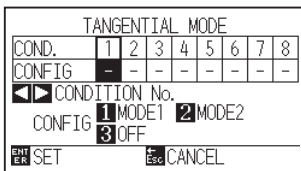

- 4 Press the POSITION (◀▶) keys and select the tool condition number (CONDITION No.).

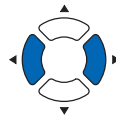

- 5 Press the [1] key (MODE1), the [2] key (MODE2), or the [3] key (OFF) to select the mode.

- 6 Confirm the setting and press the [ENTER] key (SET).

▶ Setting will be set, and it will return to CONDITION setting screen (2/4).

- 7 Press the [COND/TEST] key.

▶ It will return to default screen.

Supplement

It will return to **CONDITION** setting screen (2/4) without changing the settings when you press the [ESC] key (CANCEL).

Setting the Length of Overcut

Set the length of overcut with tangential mode.

Operation

- 1 Press the [COND/TEST] key.

▶ CONDITION setting screen (1/4) is displayed.

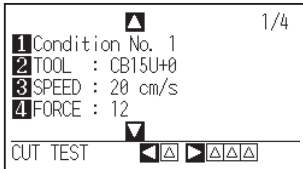

- 2 Press the POSITION (▲) key.

▶ CONDITION setting screen (2/4) is displayed

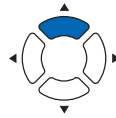
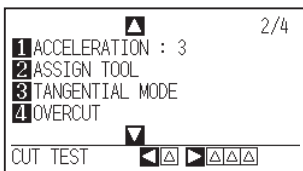

- 3 Press the [4] key (OVERCUT).

▶ OVERCUT setting screen is displayed.

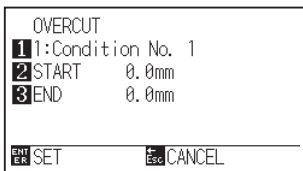

- 4 Press the [1] key (Condition No. 1)

▶ CONDITION No. selection screen is displayed.

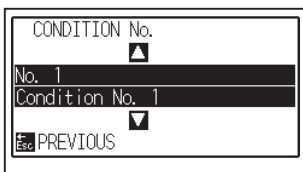

- 5 Press the POSITION (▲▼) keys and select the CONDITION No.

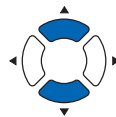

- 6 Confirm the setting, and press the [ESC] key (PREVIOUS).

▶ Condition No. will be selected, and it will return to OVERCUT setting screen.

7 Press the [2] key (START).

▶ Overcut length for START setting screen is displayed

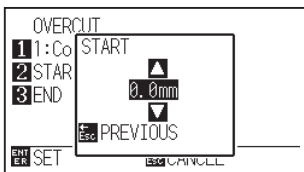

8 Press the POSITION (▲▼) keys and increase or decrease the setting value.

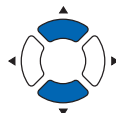

Supplement

Setting range is 0.0 mm to 3.0 mm.

9 Confirm the setting value, and press the [ESC] key (PREVIOUS).

▶ Overcut length for START will be selected, and it will return to OVERCUT setting screen.

10 Press the [3] key (END).

▶ Overcut length for END setting screen is displayed.

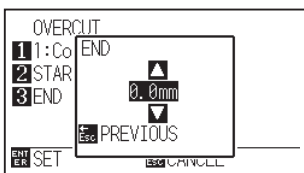

11 Press the POSITION (▲▼) keys and increase or decrease the setting value.



Supplement

Setting range is from 0.0 mm to 3.0 mm.

12 Confirm the setting value, and press the [ESC] key (PREVIOUS).

▶ Length for overcut END will be selected, and it will return to OVERCUT setting screen.

13 Repeat steps 3 to 12 as necessary to set multiple tool CONDITION No.

14 Confirm the setting and press the [ENTER] key (SET).

▶ Setting will be set, and it will return to CONDITION setting screen (2/4).

15 Press the [COND/TEST] key.

▶ It will return to default screen.

Supplement

It will return to **CONDITION** setting screen (2/4) without changing the settings when you press the [ESC] key (CANCEL).

Setting the Initial Down Force

The initial down force setting is effective when tangential mode is selected.

Tangential mode is generally used for the cutting of thick media. With thick film, additional time is required for the cutter blade to penetrate the media fully, even when the necessary cutting force is applied.

The cutting operation starts before the cutter blade has fully penetrated the media, causing uncut sections to be left.

When the initial down force is specified, this force is used as the cutting force immediately after the lowering of the tool when tangential mode is selected, enabling the cutter blade to penetrate the media rapidly. (As an example, if the cutting force is 25 and the initial down force is 4, for example, the cutting force applied immediately after the pen is lowered will be 29.)

The upper limit for added value is 40 (TOOL 1) or 80 (TOOL 2).

Operation

- 1 Press the [COND/TEST] key.

▶ CONDITION setting screen (1/4) is displayed.

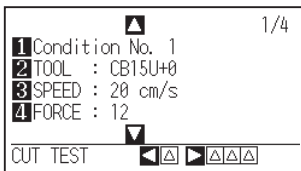

- 2 Press the POSITION (▲) key twice.

▶ CONDITION setting screen (3/4) is displayed.

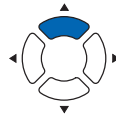
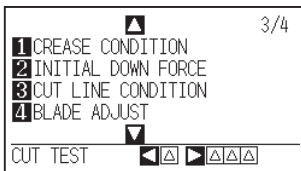

- 3 Press the [2] key (INITIAL DOWN FORCE).

▶ INITIAL DOWN FORCE setting screen is displayed.

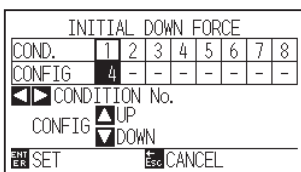

- 4 Press the POSITION (◀▶) keys and select the CONDITION No.

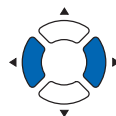

- 5 Press the POSITION (▲▼) keys and increase or decrease the setting value.



Supplement

Setting range is 0 to 20.

- 6 Confirm the setting and press the [ENTER] key (SET).
 - ▶ Setting will be set, and it will return to CONDITION setting screen (3/4).

- 7 Press the [COND/TEST] key.
 - ▶ It will return to default screen.

Supplement

It will return to **CONDITION** setting screen (3/4) without changing the settings when you press the [ESC] key (CANCEL).

7.2 Setting the Step Pass

It may not cut the curved line smoothly if there is very short lines in the curve.

It will cut in the units of the specified value when the STEP PASS is used, which allows to control the short lines with certain length, resulting to stable rotation of the blade for higher cut quality.

Setting range of STEP PASS is from 0 to 20.

Actual length of the STEP PASS is the value of the STEP PASS multiplied by the distance set in the "STEP SIZE".

- (Refer to the "Setting the Step Size")

Supplement

- This setting will be saved even if the power is turned off.
- The cut image may not be what you intended if the set value is too large. It is recommended to set to "1" for normal use.

Operation

- 1 Press the [PAUSE/MENU] key.

▶ MENU screen is displayed



- 2 Press the [1] key (TOOL).

▶ TOOLS SETTING screen (1/4) is displayed.

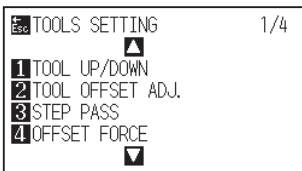

- 3 Press the [3] key (STEP PASS).

▶ STEP PASS setting screen is displayed.

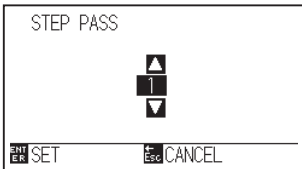

- 4 Press the POSITION (▲▼) keys and increase or decrease the setting value.

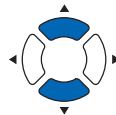

Supplement

Setting range is 0 mm to 20 mm.

- 5 Confirm the setting and press the [ENTER] key (SET).
 - ▶ Setting will be set, and it will return to TOOLS setting screen (1/4).

- 6 Press the [PAUSE/MENU] key.
 - ▶ It will return to default screen.

Supplement

It will return to TOOLS SETTING screen (1/4) without changing the settings when you press the [ESC] key (CANCEL).

7.3 Setting the Offset Angle

This plotter analyzes the cutting data, and controls the angle of the cutter blade tip if the change in the angles of the corner is large.

Angle control is applied if there is larger angle change than the angle specified as reference angle.

The time to cut is shortened by setting large value for the reference angle, since it will only apply blade control when there are angles with large angle change, hence reducing the time to make the blade control.

But, if it is set too large, there will be not enough angle control of the blade, and the cut result may differ from what was expected. Set the reference angle in good balance.

Supplement

This setting will be saved even if the power is turned off.

Operation

- 1 Press the [PAUSE/MENU] key.

▶ MENU screen is displayed.

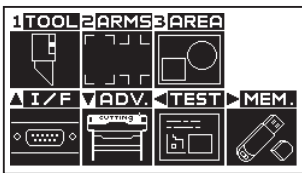

- 2 Press the [1] key (TOOL).

▶ TOOLS SETTING screen (1/4) is displayed.

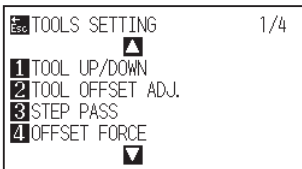

- 3 Press the POSITION (▲) key.

▶ TOOLS SETTING screen (2/4) is displayed.

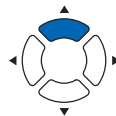
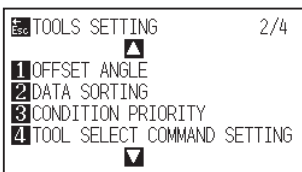

- 4 Press the [1] key (OFFSET ANGLE).

▶ OFFSET ANGLE setting screen is displayed

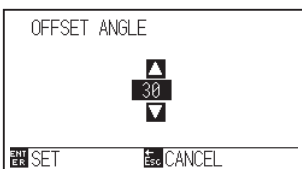

- 5 Press the POSITION (▲▼) keys and increase or decrease the setting value.

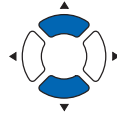

Supplement

Setting range is 0 to 60.

- 6 Confirm the setting and press the [ENTER] key (SET).
▶ Setting will be set, and it will return to TOOLS setting screen (2/4).

Supplement

It will return to **TOOLS SETTING** screen (2/4) without changing the settings when you press the [ESC] key (CANCEL).

- 7 Press the [PAUSE/MENU] key.
▶ It will return to default screen

7.4 Setting the Distance Adjust

DISTANCE ADJUST value corrects any deviation in the length of cut or plotted line segments, which occurs depending on the media being used. DISTANCE ADJUST value for the deviation is specified as a percentage of the total distance. For example, a setting of +0.05% adjusts a distance of 1000 mm by $1000 \times 0.05\% = 0.5$ mm, making 1000.5 mm.

Supplement

This setting will be saved even if the power is turned off.

Operation

- 1 Press the [PAUSE/MENU] key.

▶ MENU screen is displayed.



- 2 Press the [3] key (AREA).

▶ AREA SETTING screen (1/2) is displayed

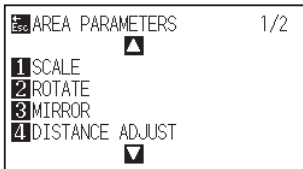

- 3 Press the [4] key (DISTANCE ADJUST).

▶ DISTANCE ADJUST setting screen is displayed.

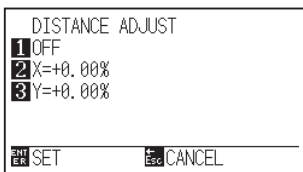

- 4 Press the [1] key (OFF).

▶ DISTANCE ADJUST setting screen is displayed.

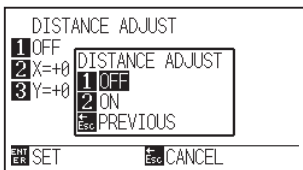

- 5 Press the [2] key (ON).

▶ DISTANCE ADJUST becomes on and [2] key (X) and [3] key (Y) becomes enabled.

6 Press the [2] key (X).

▶ X DISTANCE ADJUST setting screen is displayed.

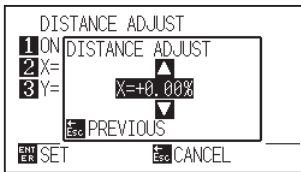

7 Press the POSITION (▲▼) keys and increase or decrease the setting value.

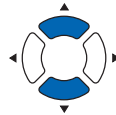

Supplement

Setting range is -0.25% to +0.25%.

8 Confirm the setting value, and press the [ESC] key (PREVIOUS).

▶ X DISTANCE ADJUST will be set, and it will return to DISTANCE ADJUST screen.

9 Press the [3] key (Y).

▶ Y DISTANCE ADJUST setting screen is displayed.

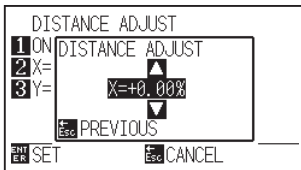

10 Press the POSITION (▲▼) keys and increase or decrease the setting value.

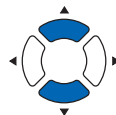

Supplement

Setting range is -0.25% to +0.25%.

11 Confirm the setting and press the [ESC] key (REVIIOUS).

▶ Y DISTANCE ADJUST will be set, and it will return to DISTANCE ADJUST setting screen.

12 Confirm the setting and press the [ENTER] key (SET).

▶ Setting will be set, and it will return to AREA SETTING screen (1/2).

13 Press the [PAUSE/MENU] key.

▶ It will return to default screen.

Supplement

It will return to AREA SETTING screen (1/2) without changing the settings when you press the [ESC] key (CANCEL).

7.5 Setting Cut Line

After turning on the power or changing pen condition settings, touch the blade to the media and adjust the blade direction.

The processing in the part is not cut with perforation patten is adjusted in "UP MODE".

The perforation setting can be set for each condition number.

Supplement

- Normally use it with default value OFF. It will cut with solid line.
- Doing a cut-out (cutting out) with a perforated setting instead of a normal film cut (half cutting) can damage the writing panel and the quality of a normal cut.

Operation

1 Press the [COND/TEST] key.

▶ CONDITION setting screen (1/4) is displayed.

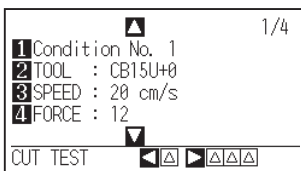

2 Press the POSITION (▲) key twice.

▶ CONDITION screen (3/4) is displayed.

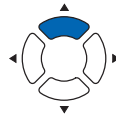
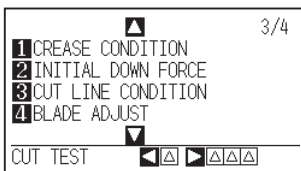

3 Press the [3] key (CUT LINE CONDITION).

▶ CUT LINE CONDITION setting screen is displayed.

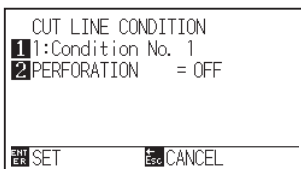

4 Press the [1] key (Condition No.).

▶ CONDITION No. selection screen is displayed.

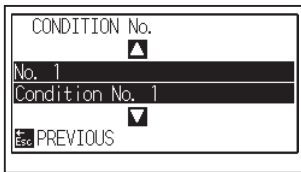

5 Press the POSITION (▲▼) key and select the CONDITION No.

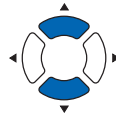

6 Confirm the setting and press the [ESC] key (PREVIOUS).

▶ CONDITION No. is selected and return to CUT LINE PATTERN setting screen.

7 Press the [2] key (PERFORATION).

▶ PERFORATION setting screen is displayed.

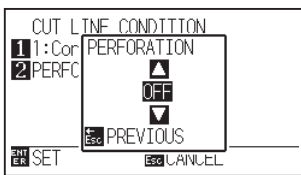

8 Press the POSITION (▲▼) keys and set the ON.

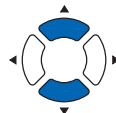

9 Confirm the setting and press the [ESC] key (PREVIOUS).

▶ PERFORATION will be set and it will return to CUT LINE CONDITION screen.

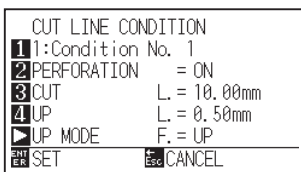

10 Press the [3] key (CUT).

▶ CUT L. setting screen is displayed.

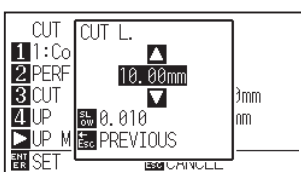

- 11 Press the POSITION (▲▼) keys and increase or decrease the setting value.

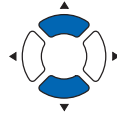

Supplement

- Setting range is 0.01 mm to 100.00 mm.
- Digits of settings can be changed by pressing the [SLOW] key.

- 12 Confirm the setting and press the [ESC] key (PREVIOUS).

▶ CUT LENGTH will be set and it will return to CUT LINE CONDITION screen.

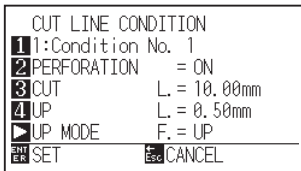

- 13 Press the [4] key (UP).

▶ UP L setting screen is displayed.

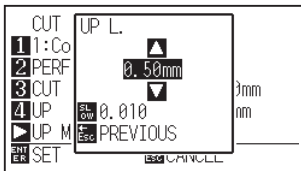

- 14 Press the POSITION (▲▼) keys and increase or decrease the setting value.

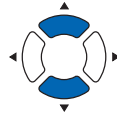

Supplement

- Setting range is 0.01 mm to 100.00 mm.
- Digits of settings can be changed by pressing the [SLOW] key.

- 15 Confirm the setting and press the [ESC] key (PREVIOUS).

▶ UP LENGTH will be set and it will return to CUT LINE CONDITION screen.

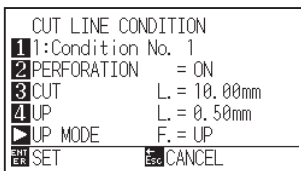

- 16 Press the POSITION (▶) key (UP MODE).

▶ UP MODE setting screen is displayed.

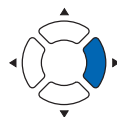
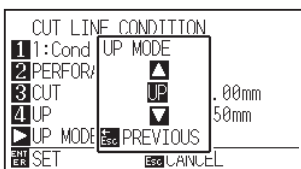

Supplement

Setting range is 1 to 40 or "UP".

17 Press the POSITION (▲▼) keys and set the UP MODE.

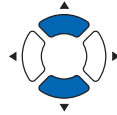

18 Confirm the setting and press the [ESC] key (PREVIOUS).

▶ UP MODE will be set and it will return to CUT LINE CONDITION screen.

19 Confirm the setting and press the [ENTER] key (SET).

▶ Setting will be set, and it will return to CONDITION screen (3/4).

20 Press the [PAUSE/MENU] key.

▶ It will return to the default screen.

Supplement

- The value set here is the **FORCE** at the part that is not cut. When “UP” is set, the tool up is started.
- By entering the smaller value than the **FORCE** at the time of the normal cut, the half cut is performed.

Supplement

It will return to **CONDITION** screen (3/4) without changing the settings when you press the **ESC** key (**CANCEL**).

7.6 Setting the Initial Blade Angle Position

After turning on the power or changing pen condition settings, touch the blade to the media and adjust the blade direction. The INITIAL BLADE ANGLE POSITION will need to be set in order to make sure the area is not damaged and that the blade properly makes contact with the media.

Selecting [2mm BELOW] will change the INITIAL BLADE ANGLE POSITION to 2 mm below the cutting start point (2 mm from the edge of the point from which the media will be shifted.) .

When selecting [Y OUTSIDE], the INITIAL BLADE ANGLE POSITION is performed out of the Y-direction range of the cutting area. Selecting [XY OUTSIDE] is out of the X- and Y-direction range of the cutting area.

When selecting the [SPECIFIED POSITION], you can specify any location.

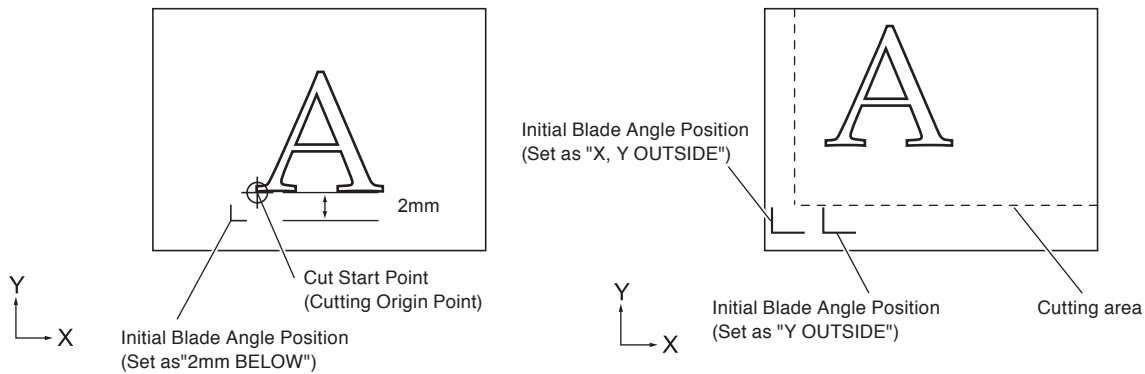

Operation

- 1 Press the [PAUSE/MENU] key.

▶ MENU screen is displayed.



- 2 Press the [1] key (TOOL).

▶ TOOLS SETTING screen (1/4) is displayed.

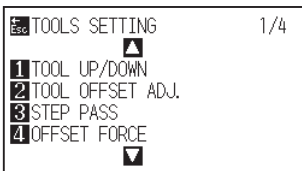

- 3 Press the POSITION (▼) key.

▶ TOOLS SETTING screen (4/4) is displayed.

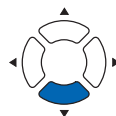
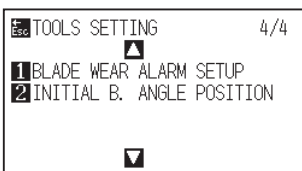

4 Press the [2] key (INITIAL B. ANGLE POSITION).

▶ INITIAL BLADE ANGLE POSITION setting screen is displayed.

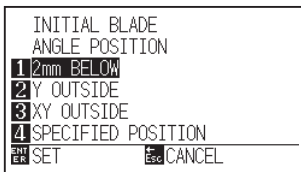

5 Press the [1] key (2mm BELOW), the [2] key (Y OUTSIDE), the [3] key (XY OUTSIDE) or the [4] key (SPECIFIED POSITION).

When pressing the [4] key (SPECIFIED POSITION), you need to specify the tool position by moving the tool.

6 Confirm the setting and press the [ENTER] key (SET).

▶ Setting will be set, and it will return to TOOLS SETTING screen (4/4).

7 Press the [PAUSE/MENU] key.

▶ It will return to default screen

Supplement

It will return to **TOOLS SETTING** screen (4/4) without changing the setting when you press the [ESC] key (CANCEL).

7.7 Settings for OFFSET FORCE

Slight cut operation is performed before the actual cut operation to align the blade toward the cutting direction. Lower FORCE is necessary compared with the normal cutting, so it is possible to set lower FORCE as an OFFSET FORCE.

OFFSET FORCE is used to control the rotation of the blade with the tangential mode in addition to control the blade direction at the beginning of the cut.

Operation

- 1 Press the [PAUSE/MENU] key.

▶ MENU screen is displayed.

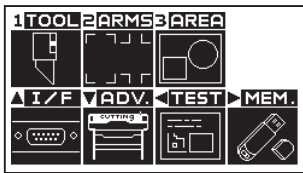

- 2 Press the [1] key (TOOL).

▶ TOOLS SETTING screen (1/4) is displayed.

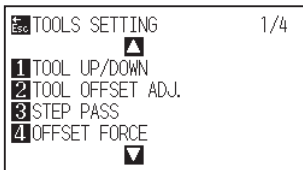

- 3 Press the [4] key (OFFSET FORCE).

▶ OFFSET FORCE setting screen is displayed.

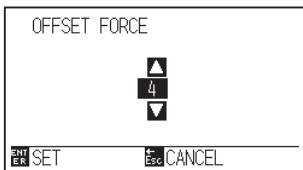

- 4 Press the POSITION (▲▼) keys and increase or decrease the setting value.

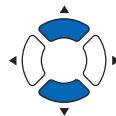

Supplement

Setting range is 1 to 40.

- 5 Confirm the setting and press the [ENTER] key (SET).

▶ Setting will be set, and it will return to TOOLS SETTING screen (1/4).

- 6 Press the [PAUSE/MENU] key.

▶ It will return to default screen.

Supplement

It will return to TOOLS SETTING screen (1/4) without changing the settings when you press the [ESC] key (CANCEL).

7.8 Setting the Overlay Cut Function

The Overlay Cut function enables repeated cutting to be performed on a medium that cannot be cut with one cutting operation. In the first cutting operation, a cutting force that is lighter than the specified FORCE value is used to leave cutting trace marks on the medium. For the second and subsequent cutting operations, the specified FORCE value is used.

Supplement

- This setting will be saved even if the power is turned off.
- If the tool is set to "Pen" or "Creasing", it does not work.

Operation

1 Press the [COND/TEST] key.

▶ CONDITION setting screen (1/4) is displayed.

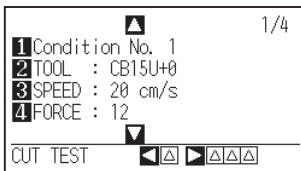

2 Press the POSITION (▼) key.

▶ CONDITION setting screen (4/4) is displayed.

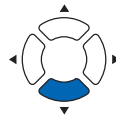
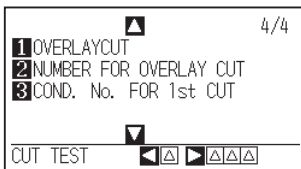

3 Press the [1] key (OVERLAYCUT).

▶ OVERLAYCUT setting screen is displayed.

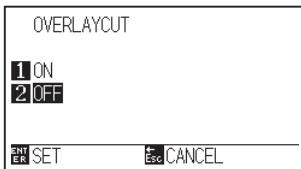

4 Press the [1] key (ON).

5 Confirm the setting and press the [ENTER] key (SET).

▶ Setting will be set, and it will return to CONDITION SETTING screen (4/4).

6 Press the [2] key (NUMBER FOR OVERRLAY CUT).

▶ NUMBER FOR OVERRLAY CUT screen is displayed.

NUMBER FOR OVERLAY CUT								
COND.	1	2	3	4	5	6	7	8
CONFIG	-	-	-	-	-	-	-	-
◀▶ CONDITION No.								
CONFIG ▲UP								
▼DOWN								
ENT SET								ESC CANCEL

7 Press the POSITION (▲▼) keys and increase or decrease the setting value.

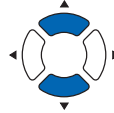

Supplement

Setting range is (OFF) or 2 to 9 (time).

8 Confirm the setting and press the [ENTER] key (SET).

▶ Setting will be set, and it will return to CONDITION setting screen (4/4).

Supplement

It will return to **CONDITION** setting screen (4/4) without changing the setting when you press the [ESC] key (CANCEL).

9 Press the [3] key (COND. No. FOR 1st CUT).

▶ COND. No. FOR 1st CUT screen is displayed

COND. No. FOR 1st CUT								
COND.	1	2	3	4	5	6	7	8
CONFIG	1	-	-	-	-	-	-	-
◀▶ CONDITION No.								
CONFIG ▲UP								
▼DOWN								
ENT SET								ESC CANCEL

10 Press the POSITION (▲▼) keys and increase or decrease the setting value.

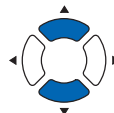

Supplement

Setting range is 1 to 8.

11 Confirm the setting and press the [ENTER] key (SET).

▶ Setting will be set, and it will return to CONDITION setting screen (4/4).

Supplement

It will return to **CONDITION** setting screen (4/4) without changing the setting when you press the [ESC] key (CANCEL).

12 Press the [PAUSE/MENU] key.

▶ It will return to default screen

Chapter 8:

Settings Regarding Cutting Time

Time necessary for cutting depends on the speed to move the tool and media, and efficiency of the operation. It is best to cut slowly and carefully to cut precisely, but the speed is required to enhance the operational efficiency. The setting needs to be in good balance considering the characteristics of the media and tools, and the contents of the cutting data.

This chapter describes the settings affecting the cutting time.

In addition to this chapter, there are settings affecting the cutting times in following places.

- Selecting Tool Condition
- Setting Mark Distance

PRODUCT SUMMARY

8.1 Sorting the Cutting Data

8.2 Setting the Tool Up Move

8.3 Setting the Tool Up Speed

8.4 Setting the Tool Up Height

8.1 *Sorting the Cutting Data*

By sorting the cutting data, you can reduce the unnecessary movement of the tool exchange during the cutting and shorten the cutting time.

When performing the sorting process in this plotter, it may take some time. Receiving the data sorted by the application software, after setting the sorting process of the plotter to OFF, can be processed faster.

OFF : Sorting process is disabled.

- 1 : By grouping the data those are cut with the same tool in the received data, it can reduce the tool exchange number of times and shorten the time it takes to tool exchange.
- 2 : It is the same as the setting of "1", but the conditions that the cutter has been set is used for the last.

Supplement

- The sorting process is performed after storing the data in the buffer memory, so it takes some time until the cutting is started.
- Please preliminarily register the tool to be used for sorting in the setting conditions No.1 to 8. (See "Setting the Cutting Conditions".)

Operation

- 1 Press the [PAUSE/MENU] key.

▶ MENU screen is displayed.



- 2 Press the [1] key (TOOL).

▶ TOOLS SETTING screen (1/4) is displayed.

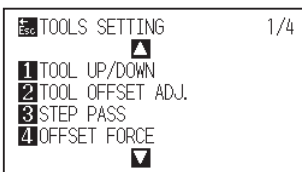

- 3 Press the POSITION (▲) key.

▶ TOOLS SETTING screen (2/4) is displayed.

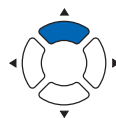
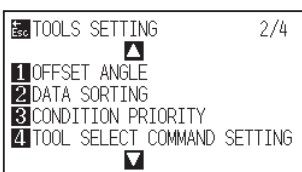

4 Press the [1] key (DATA SORTING).

▶ DATA SORTING setting screen is displayed

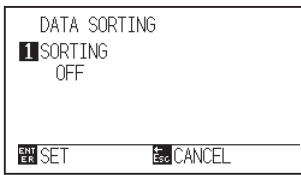

5 Press the [1] key (OFF).

▶ DATA SORTING setting screen is displayed

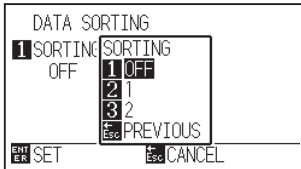

6 Press the [1] key (OFF), [2] key (1) or the [3] key (2).

7 Confirm the setting and press the [ENTER] key (SET).

▶ Setting will be set, and it will return to TOOLS SETTING screen (2/4).

8 Press the [PAUSE/MENU] key.

▶ It will return to default screen.

Supplement

It will return to **TOOLS SETTING screen (4/4)** without changing the settings when you press the [ESC] key (**BLADE WEAR ALARM SETUP**).

Supplement

[] mark is displayed at the right of the screen when **SORT MODE** is set.

8.2 Setting the Tool Up Move

When the coordinate information to move in a state in which the tool is raised is received continuously from the computer connected to this plotter, "TOOL UP MOVE" is used to set whether to move to every coordinate in order or go directly to the last one .

There are two settings for "TOOL UP MOVE" as shown below.

ENABLED : If several coordinates are received continuously, it will move to each in order it is received.

DISABLED : If several coordinates are received continuously, it will directly move to the last coordinate received.

Cutting time can be reduced if it is set to "DISABLED", if the time to move the tool in raised status is wasteful.

Supplement

This setting will be saved even if the power is shut off.

Operation

- 1 Press the [PAUSE/MENU] key.

▶ MENU screen is displayed.

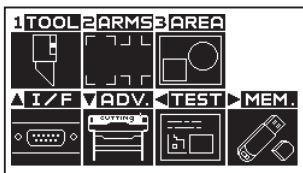

- 2 Press the [1] key (TOOL).

▶ TOOLS SETTING screen (1/4) is displayed.

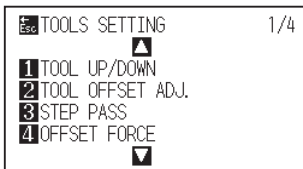

- 3 Press the POSITION (▲) key twice.

▶ TOOLS SETTING screen (3/4) is displayed.

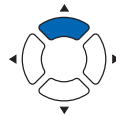
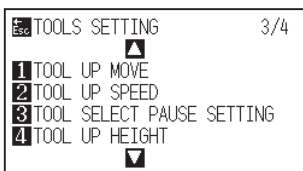

- 4 Press the [1] key (TOOL UP MOVE).

▶ TOOL UP MOVE setting screen is displayed.

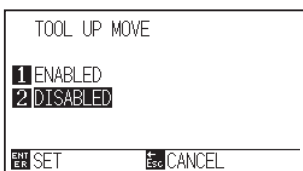

- 5 Press the [1] key (ENABLED) or the [2] key (DISABLED).
- 6 Confirm the setting and press the [ENTER] key (SET).
 - ▶ Setting will be set, and it will return to TOOLS SETTING screen (3/4).
- 7 Press the [PAUSE/MENU] key.
 - ▶ It will return to default screen.

Supplement

It will return to TOOLS SETTING screen (3/4) without changing the settings when you press the [ESC] key (CANCEL).

8.3 Setting the Tool Up Speed

TOOL UP SPEED is the speed the tool moves when it is raised.

The cutting time in total becomes short if you set the TOOL UP SPEED to fast speed even though the speed of the tool when it is cutting (lowered) is set to slow speed for the hard to cut media (hard or sticky).

Supplement

This setting will be saved even if the power is turned off.

Operation

- 1 Press the [PAUSE/MENU] key.

▶ MENU screen is displayed.

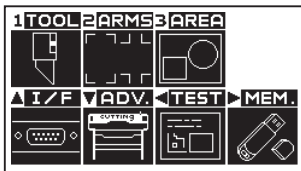

- 2 Press the [1] key (TOOL).

▶ TOOLS SETTING screen (1/4) is displayed

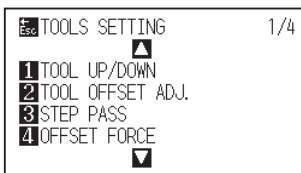

- 3 Press the POSITION (▲) key twice.

▶ TOOLS SETTING screen (3/4) is displayed.

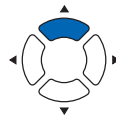
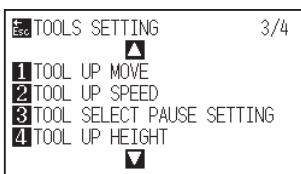

- 4 Press the [2] key (TOOL UP SPEED).

▶ TOOL UP SPEED setting screen is displayed.

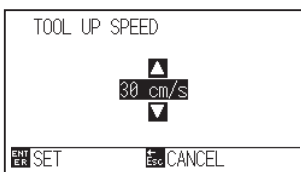

- 5 Press the POSITION (▲▼) keys and increase or decrease the setting value.

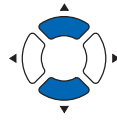

Supplement

- Values that can be set are AUTO, 10, 20, 30, and 40 cm/s.
- It will be same speed as tool is lowered (TOOL DOWN) when AUTO is selected.

- 6 Confirm the setting and press the [ENTER] key (SET).

▶ Setting will be set, and it will return to TOOLS SETTING screen (3/4).

Supplement

It will return to TOOLS SETTING screen (3/4) without changing the settings when you press the [ESC] key (CANCEL).

- 7 Press the [PAUSE/MENU] key.

▶ It will return to default screen.

8.4 Setting the Tool Up Height

The TOOL UP HEIGHT is the height of the tool position when the tool is raised.

Set to "HIGHT POSITION" if the media is thick. Usually, set to the "NORMAL POSITION".

Supplement

This setting will be saved even if the power is turned off.

Operation

- 1 Press the [PAUSE/MENU] key.

▶ MENU screen is displayed.

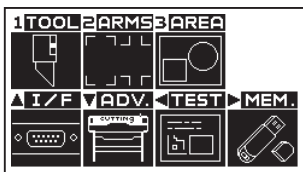

- 2 Press the [1] key (TOOL).

▶ TOOLS SETTING screen (1/4) is displayed.

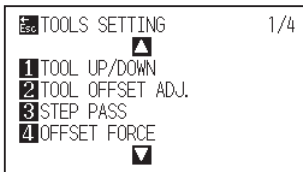

- 3 Press the POSITION (▲) key twice.

▶ TOOLS SETTING screen (3/4) is displayed.

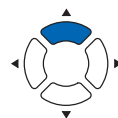
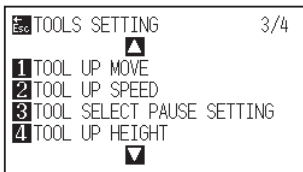

- 4 Press the [4] key (TOOL UP HEIGHT).

▶ TOOL UP HEIGHT setting screen is displayed.

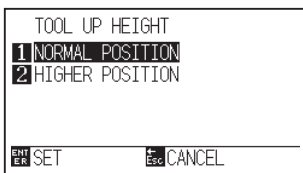

- 5 Press the [1] key (NORMAL POSITION) or the [2] key (HIGHER POSITION).
- 6 Confirm the setting and press the [ENTER] key (SET).
 - ▶ Setting will be set, and it will return to TOOLS SETTING screen (3/4).
- 7 Press the [PAUSE/MENU] key.
 - ▶ It will return to default screen.

Supplement

It will return to TOOLS SETTING screen (3/4) without changing the settings when you press the [ESC] key (CANCEL).

Chapter 9: Setting Regarding Interface

This chapter describes setting regarding interface.

PRODUCT SUMMARY

- 9.1 *Setting the Interface***
- 9.2 *Clearing the Buffer Memory***
- 9.3 *I/F(LAN)***
- 9.4 *When Connecting the RS-232C Interface***

9.1 Setting the Interface

This section describes how to set the interface.

This plotter has the USB, RS-232C and Network (LAN) interfaces, which switches each interface automatically.

To use one of the interfaces on this plotter, you need to install the driver software on the PC. For the installation of the driver software, see “Setup Manual”.

USB Interface

To use the USB interface, the driver software must be installed on the computer.

For the plotter side, please perform command settings*, step size settings (when using GP-GL commands), and origin point settings for HP-GL (when using HP-GL commands).

CAUTION

Operation cannot be guaranteed in the following cases:

- When the plotter is connected to a USB hub or extension port.
- When the plotter is connected to a hand-built or modified computer.
- When a driver other than the one provided as a standard accessory is used.

Notes when using the USB 3.0 interface

- Because that some computer equipped with a USB 3.0 interface is not compatible with USB 2.0 or later interface, you need to check it.

Do not perform the followings:

- Do not connect or disconnect the USB cable while installing the USB driver on the computer.
- Do not connect or disconnect the USB cable when the computer or the plotter is performing an initialization routine.
- Do not disconnect the USB cable within a 5-second period of connecting it.
- Do not disconnect the cable during data transfer.

Do not connect multiple plotters to a single computer using the USB interface. •

Network (LAN) interface

To use the network (LAN) interface, the settings of the computer and the device such as a network hub have been completed and the environment that can connect the computer to the network must be established.

In addition, temporarily turn off the firewall function during the use, or change the settings. If you want to turn off the firewall function, disconnect the network from the Internet.

CAUTION

- To connect through a LAN, you need a network (LAN) cable and a network hub. Please purchase them separately.
- Configuration of network equipment and the presence or absence of the router function depends on your environment. For details, please see the equipment manual, or consult the manufacturer or network administrator.
- Ethernet is compliant with 10BASE-T/100BASE-TX. Please check your network environment.

RS-232C Interface

When using the RS-232C interface, set the command settings, step size settings (when using GP-GL commands), origin point settings for HP-GL (when using HP-GL commands), and transfer conditions for the RS-232C interface. The transfer conditions for the RS-232C interface can be set from the operations panel. The transfer condition should be set to the same in the software used and in the FCX2000. If there is a mistake in the settings an error may displayed in the machine and lack of data can cause a malfunction. In such a case, please confirm the data transfer settings again.

(Refer to the "Setting Origin Point When HP-GL is set")

(Refer to the "Setting the Step Size")

(Refer to the "Setting the Command (COMMAND)")

(Refer to the "Setting the Step Size (GP-GL STEP SIZE)")

9.2 Clearing the Buffer Memory

This function allows you to clear all the output data in the plotter's buffer memory.

CAUTION

- Do not execute the BUFFER CLEAR function until the computer has completed data output.
- If you clear the buffer while the computer is still sending data to the plotter, the data received up to the time that PAUSE mode was selected is cleared but the computer resumes sending subsequent data which remains in the buffer. When the [PAUSE] key is pressed to cancel PAUSE mode, that data is cut/plotted. At such time, the pen carriage may suddenly start moving so please be careful.

Supplement

If you selected [CANCEL] key on the BUFFER CLEAR screen, the cutting operation resumes as soon as the [PAUSE] key is pressed to cancel PAUSE mode.

Operation

- 1 Press the [PAUSE/MENU] key.

▶ MENU screen is displayed.

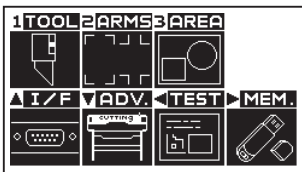

- 2 Press the (▲) key (I/F).

▶ INTERFACE setting screen (1/3) is displayed.

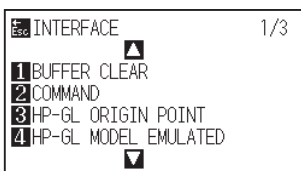

- 3 Press the [1] key (BUFFER CLEAR).

▶ BUFFER CLEAR screen is displayed.

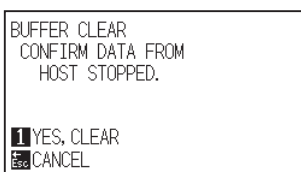

- 4 Press the [1] key (YES, CLEAR).

▶ The buffer will be cleared and it will return to default screen.

Supplement

It will return to INTERFACE setting screen (1/3) without clearing the buffer when you press the [ESC] key (CANCEL).

9.3 I/F (LAN)

Clear the output data in the buffer memory.

Set the network interface (LAN).

Supplement

When you change the settings of the network, the plotter is reset.

To connect through a network (LAN), it is necessary to set the following items.

- Set the DHCP
- Set the IP address
- Enter the subnet mask
- Enter the gateway
- Display the MAC address

Set the DHCP

DHCP settings depend on the configuration of network equipment and the customer's environment. For details, please see the equipment manual, or consult the network administrator.

The default setting of DHCP is OFF.

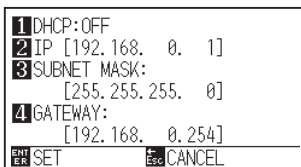

Operation

- 1 Press the [PAUSE/MENU] key.

▶ MENU screen is displayed.

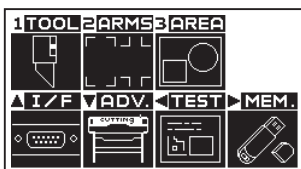

- 2 Press the (▲) key (I/F).

▶ INTERFACE setting screen (1/3) is displayed.

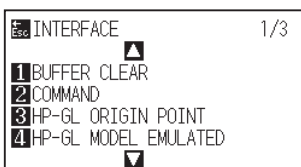

3 Press the POSITION (▲) key.

▶ INTERFACE setting screen (2/3) is displayed.

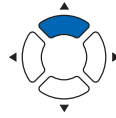
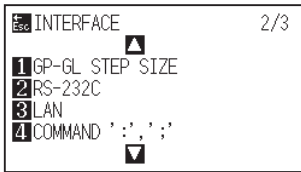

4 Press the [3] key (LAN).

▶ Network (LAN) setting screen is displayed.

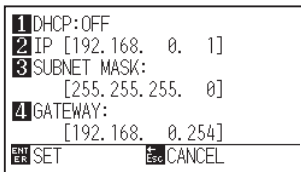

5 Press the [1] key (DHCP:OFF).

▶ DHCP setting screen is displayed.

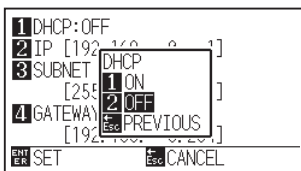

6 Press the [1] key (ON) or the [2] key (OFF).

7 Confirm the setting and press the [ENTER] key (SET).

▶ Setting will be set, and it will return to INTERFACE setting screen (2/3).

8 Press the [PAUSE/MENU] key.

▶ It will return to default screen.

Supplement

It will return to INTERFACE setting screen (2/3) without changing the settings when you press the [ESC] key (CANCEL).

Set IP address, Subnet Mask and Gateway

When the DHCP is set to [OFF], Set IP address, subnet mask and gateway.

When the DHCP is set to [ON], IP address, subnet mask and gateway obtained from the DHCP server are displayed.

Operation

- 1 Press the [PAUSE/MENU] key.

▶ MENU screen is displayed.



- 2 Press the (▲) key (I/F).

▶ INTERFACE setting screen (1/3) is displayed.

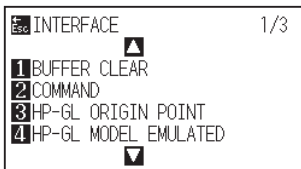

- 3 Press the POSITION (▲) key.

▶ INTERFACE setting screen (2/3) is displayed.

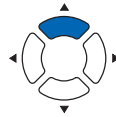

- 4 Press the [3] key (LAN).

▶ Network (LAN) setting screen is displayed.

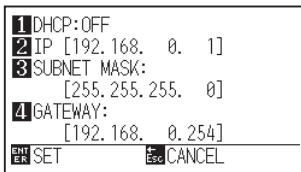

- 5 Press the [2] key (IP).

▶ IP setting screen is displayed.

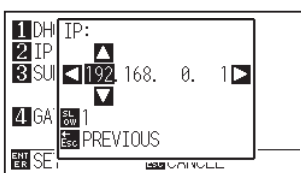

6 Press the POSITION (▲▼◀▶) keys and set the IP address.

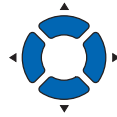

Supplement

By pressing the [SLOW] key, you can change the digit of the setting.

7 Confirm the setting and press the [ESC] key (PREVIOUS).

▶ Network (LAN) setting screen is displayed.

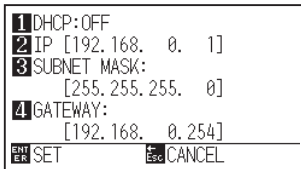

8 Press the [3] key (SUBNET MASK).

▶ SUBNET MASK setting screen is displayed.



9 Press the POSITION (▲▼◀▶) keys and set the subnet mask.

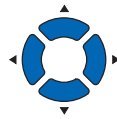

Supplement

By pressing the [SLOW] key, you can change the digit of the setting.

10 Confirm the setting and press the [ESC] key (PREVIOUS).

▶ Network (LAN) setting screen is displayed.



11 Press the [4] key (GATEWAY).

▶ GATEWAY setting screen is displayed.

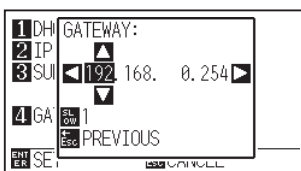

12 Press the POSITION (▲▼◀▶) keys and set the gateway.

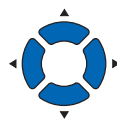

Supplement

By pressing the [SLOW] key, you can change the digit of the setting.

13 Confirm the setting and press the [ESC] key (PREVIOUS).

▶ Network (LAN) setting screen is displayed.

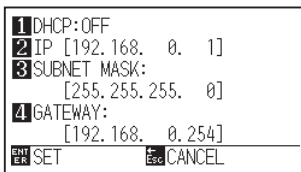

Supplement

When you press the [▶] key in the Network (LAN) setting screen, the Mac address is displayed.

14 Confirm the setting and press the [ENTER] key (SET).

▶ When the settings are changed, the plotter is reset and default screen is displayed.

Supplement

It will return to INTERFACE setting screen (2/3) without changing the settings when you press the [ESC] key (CANCEL).

9.4 When Connecting the RS-232C Interface

For the RS-232C settings, it is possible to call any setting by storing the three different setting types of 1 to 3. See "Switching Setting Numbers" to call out the settings to use, and see "Changing and Storing RS-232C Settings" to change and save the settings.

Switching Setting Numbers

Operation

1 Press the [PAUSE/MENU] key.

▶ MENU screen is displayed.

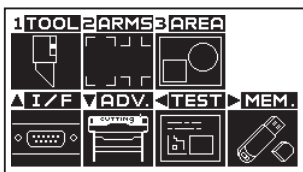

2 Press the (▲) key (I/F).

▶ INTERFACE setting screen (1/3) is displayed.

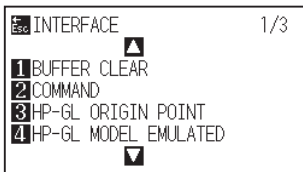

3 Press the POSITION (▲) key.

▶ INTERFACE setting screen (2/3) is displayed.



4 Press the [2] key (RS-232C).

▶ RS-232C setting screen is displayed.

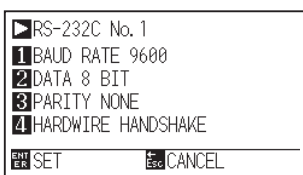

Supplement

It will return to INTERFACE setting screen (2/3) without changing the settings when you press the [ESC] key (CANCEL).

5 Press the POSITION (▶) key.

▶ RS-232C setting number select screen is displayed.

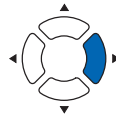
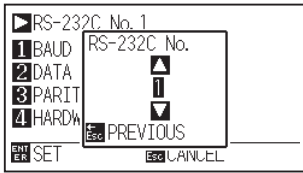

6 Press the POSITION (▲▼) keys, and select the settings number.

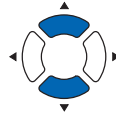

Supplement

Setting numbers is 1 to 3.

7 Confirm the setting and press the ESC key (PREVIOUS).

▶ It will return to RS-232C setting screen.

8 Confirm the setting and press the [ENTER] key (SET).

▶ Setting will be set, and it will return to INTERFACE setting screen (2/3).

9 Press the [PAUSE/MENU] key.

▶ It will return to default screen.

Changing and Storing RS-232C Settings

Operation

1 Press the [PAUSE/MENU] key.

▶ MENU screen is displayed.



2 Press the (▲) key (I/F).

▶ INTERFACE setting screen (1/3) is displayed.

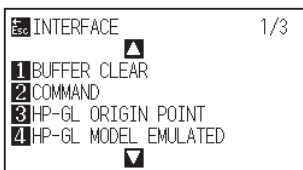

- 3 Press the POSITION (▲) key.
 ► INTERFACE setting screen (2/3) is displayed.

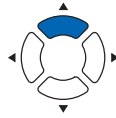

- 4 Press the [2] key (RS-232C).
 ► RS-232C setting screen is displayed.

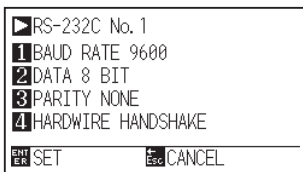

Supplement

It will return to INTERFACE setting screen (2/3) without changing the settings when you press the [ESC] key (CANCEL).

- 5 Press the [1] key (BAUD RATE).
 ► BAUD RATE setting screen is displayed.

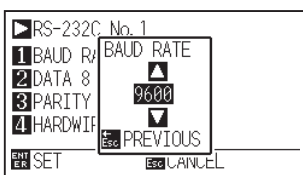

Supplement

Baud rate can be selected from 19200, 9600, 4800, 2400, 1200, 600 or 300.

- 6 Press the POSITION (▲▼) keys and increase or decrease the setting value.

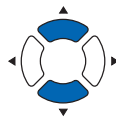

Supplement

Match the setting value of the application being used currently.

- 7 Confirm the setting and press the ESC key (PREVIOUS).
 ► BAUD RATE will be set, and it will return to RS-232C setting screen.

- 8 Press the [2] key (DATA BIT).
 ► PARITY setting screen is displayed.

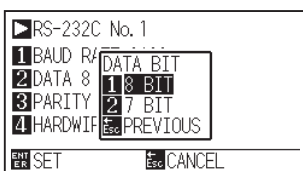

- 9 Press the [1] key (8 BIT) or the [2] key (7 BIT).
 ▶ DATA BIT will be set, and it will return to RS-232C setting screen.

Supplement

- Match the setting value of the application being used currently.
- It will return to RS-232C setting screen without changing the settings when you press [ESC] key (CANCEL).

- 10 Press the [3] key (PARITY).
 ▶ PARITY setting screen is displayed.

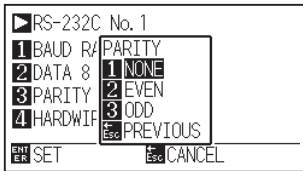

- 11 Press the [1] key (NONE), [2] key (EVEN), or the [3] key (ODD).
 ▶ PARITY will be set, and it will return to RS-232C setting screen.

Supplement

- Match the setting value of the application being used currently.
- It will return to RS-232C setting screen without changing the settings when you press [ESC] key (CANCEL).

- 12 Press the [4] key (HANDSHAKE).
 ▶ HANDSHAKE setting screen is displayed

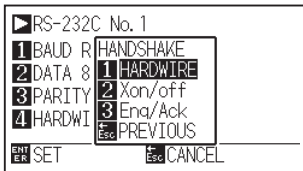

- 13 Press the [1] key (HARDWI), the [2] key (Xon/off), or the [3] key (Enq/Ack).
 ▶ HANDSHAKE will be selected, and it will return to RS-232C setting screen.

Supplement

- Match the setting value of the application being used currently.
- It will return to RS-232C setting screen without changing the settings when you press [ESC] key (CANCEL).
- Enq/Ack setting is valid only when it is set to HP-GL. It will be set to HARDWI even if Enq/Ack is selected when it is set to GP-GL.

- 14 Confirm the setting and press the [ENTER] key (SET).
 ▶ Setting will be set, and it will return to INTERFACE setting screen (2/3).

- 15 Press the [PAUSE/MENU] key.
 ▶ It will return to default screen.

Chapter 10: ***Setting Regarding Operation Environment***

This chapter describes setting regarding the operation environment

Related to Menu Display

Display Language Setting (LANGUAGE SELECTION)

This function sets the language used on the display.

One of three languages can be selected: English, Japanese, and Chinese.

Operation

- 1 Press the [PAUSE/MENU] key.

▶ MENU screen is displayed



- 2 Press the POSITION [▼] key (ADV.).

▶ ADVANCE setting screen (1/3) is displayed.

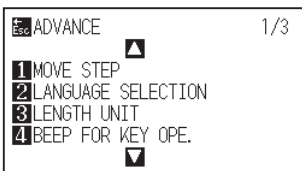

- 3 Press the [2] key (LANGUAGE SELECTION).

▶ LANGUAGE SELECTION screen is displayed.

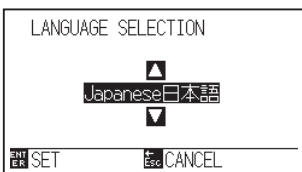

- 4 Press the POSITION (▲▼) key and select the language.

(In these instructions it's explained for when it's set to English.)

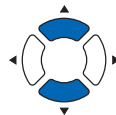

- 5 Confirm the setting and press the [ENTER] key (SET).

▶ Setting will be set, and it will return to ADVANCE setting screen (1/3).

- 6 Press the [PAUSE/MENU] key.

▶ It will return to default screen.

Supplement

It will return to ADVANCE setting screen (1/3) without changing the settings when you press the ESC key (CANCEL).

Setting the Display Length Unit (LENGTH UNIT)

The coordinate values that appear on the display and the other parameters for various settings can be changed to either meter or inch display.

Operation

- 1 Press the [PAUSE/MENU] key.

▶ MENU screen is displayed



- 2 Press the POSITION [▼] key (ADV.).

▶ ADVANCE setting screen (1/3) is displayed.

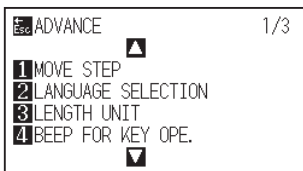

- 3 Press the [3] key (LENGTH UNIT).

▶ LENGTH UNIT screen is displayed.

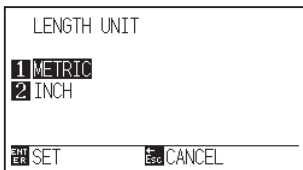

- 4 Press the [1] key (METRIC), or the [2] key (INCH).

- 5 Confirm the setting and press the [ENTER] key (SET).

▶ Setting will be set, and it will return to ADVANCE setting screen (1/3).

- 6 Press the [PAUSE/MENU] key.

▶ It will return to default screen.

Supplement

It will return to ADVANCE setting screen (1/3) without changing the settings when you press the ESC key (CANCEL).

Related to Plotter Environment

Enabling/Disabling the Beep Setting (BEEP FOR KEY OPERATION)

This function selects whether to enable or disable the beep that is emitted whenever a control panel key is pressed.

Operation

- 1 Press the [PAUSE/MENU] key.

▶ MENU screen is displayed



- 2 Press the POSITION [▼] key (ADV.).

▶ ADVANCE setting screen (1/3) is displayed.

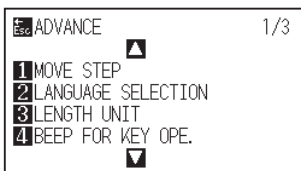

- 3 Press the [4] key (BEEP FOR KEY OPE.).

▶ BEEP FOR KEY OPE. setting screen is displayed.

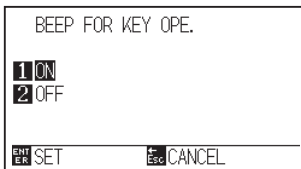

- 4 Press the [1] key (ON), or the [2] key (OFF).

- 5 Confirm the setting and press the [ENTER] key (SET).

▶ Setting will be set, and it will return to ADVANCE setting screen (1/3).

- 6 Press the [PAUSE/MENU] key.

▶ It will return to default screen.

Supplement

It will return to ADVANCE setting screen (1/3) without changing the settings when you press the ESC key (CANCEL).

Setting the force (SWITCHING XY FORCE)

This is used to switch the FORCE for each X and Y directions. Set the FORCE to ENABLED or DISABLED.

Operation

- 1 Press the [PAUSE/MENU] key.

▶ MENU screen is displayed



- 2 Press the POSITION [▼] key (ADV.).

▶ ADVANCE setting screen (1/3) is displayed.

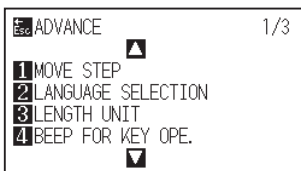

- 3 Press the POSITION (▲) key.

▶ ADVANCE setting screen (2/3) is displayed.

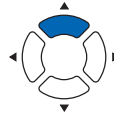
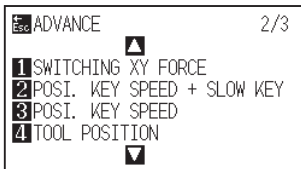

- 4 Press the [1] key (SWITCHING XY FORCE).

▶ SWITCHING XY FORCE. setting screen is displayed.

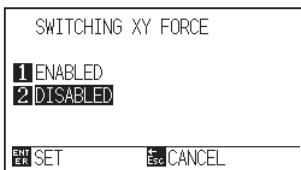

- 5 Press the [1] key (ENABLED), or the [2] key (DISABLED).

- 6 Confirm the setting and press the [ENTER] key (SET).

▶ Setting will be set, and it will return to ADVANCE setting screen (2/3).

- 7 Press the [PAUSE/MENU] key.

▶ It will return to default screen.

Supplement

It will return to ADVANCE setting screen (2/3) without changing the settings when you press the ESC key (CANCEL).

Setting the position key low speed (POSI. KEY SPEED + SLOW KEY)

Use the POSITION (▲▼◀▶) keys to set the speed in the case of slow-moving.

Operation

- 1 Press the [PAUSE/MENU] key.

▶ MENU screen is displayed



- 2 Press the POSITION [▼] key (ADV.).

▶ ADVANCE setting screen (1/3) is displayed.

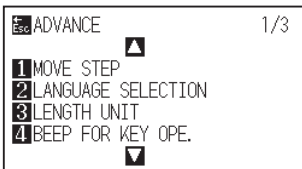

- 3 Press the POSITION (▲) key.

▶ ADVANCE setting screen (2/3) is displayed.

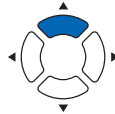
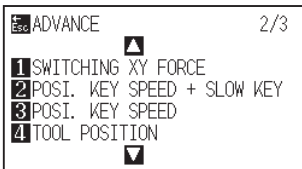

- 4 Press the [2] key (POSI. KEY SPEED + SLOW KEY).

▶ POSI. KEY SPEED + SLOW KEY setting screen is displayed.

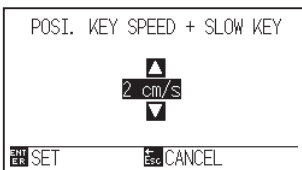

- 5 Press the POSITION (▲▼) keys and increase or decrease the setting value.

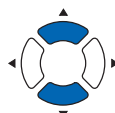

Supplement

Setting range is 1 to 30 (cm/s).

- 6 Confirm the setting and press the [ENTER] key (SET).

▶ Setting will be set, and it will return to ADVANCE setting screen (2/3).

- 7 Press the [PAUSE/MENU] key.

▶ It will return to default screen.

Supplement

It will return to ADVANCE setting screen (2/3) without changing the settings when you press the ESC key (CANCEL).

Setting the position key high speed (POSI. KEY SPEED)

Use the POSITION (▲▼◀▶) keys to set the speed in the case of fast-moving.

Operation

- 1 Press the [PAUSE/MENU] key.

▶ MENU screen is displayed



- 2 Press the POSITION [▼] key (ADV.).

▶ ADVANCE setting screen (1/3) is displayed.

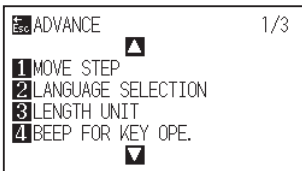

- 3 Press the POSITION (▲) key.

▶ ADVANCE SETTING screen (2/3) is displayed.

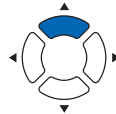
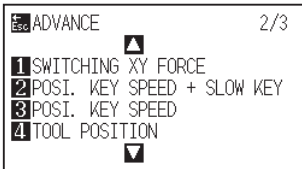

- 4 Press the [3] key (POSI. KEY SPEED).

▶ POSI. KEY SPEED setting screen is displayed.

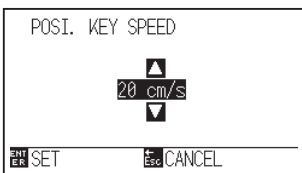

- 5 Press the POSITION (▲▼) key and increase or decrease the setting value.

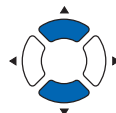

Supplement

Setting range is 1 to 30 (cm/s).

- 6 Confirm the setting and press the [ENTER] key (SET).

▶ Setting will be set, and it will return to ADVANCE setting screen (2/3).

- 7 Press the [PAUSE/MENU] key.

▶ It will return to default screen.

Supplement

It will return to ADVANCE setting screen (2/3) without changing the settings when you press the ESC key (CANCEL).

Setting the display of the position key (TOOL POSITION)

Set whether to display the tool position when the [SLOW] key is pressed.

Operation

- 1 Press the [PAUSE/MENU] key.

▶ MENU screen is displayed



- 2 Press the POSITION [▼] key (ADV.).

▶ ADVANCE setting screen (1/3) is displayed.

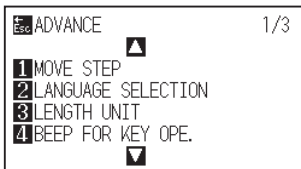

- 3 Press the POSITION (▲) key.

▶ ADVANCE setting screen (2/3) is displayed.

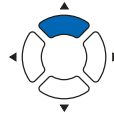
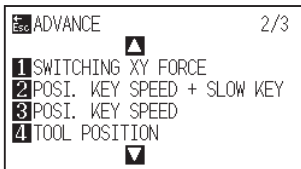

- 4 Press the [4] key (TOOL POSITION).

▶ TOOL POSITION setting screen is displayed.

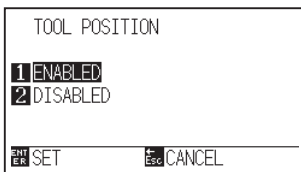

- 5 Press the [1] key (DISABLED), or the [2] key (ENABLED).

- 6 Confirm the setting and press the [ENTER] key (SET).

▶ Setting will be set, and it will return to ADVANCE setting screen (2/3).

- 7 Press the [PAUSE/MENU] key.

▶ It will return to default screen.

Supplement

It will return to ADVANCE setting screen (2/3) without changing the settings when you press the ESC key (CANCEL).

Setting the pause key (PAUSE/MENU KEY SETTING)

Set the screen to be displayed when the [PAUSE/MENU] key is pressed during data reception.

Operation

- 1 Press the [PAUSE/MENU] key.

▶ MENU screen is displayed



- 2 Press the POSITION [▼] key (ADV.).

▶ ADVANCE setting screen (1/3) is displayed.

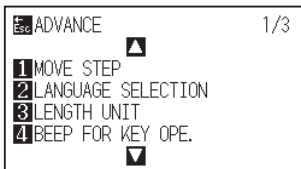

- 3 Press the POSITION (▼) key.

▶ ADVANCE setting screen (3/3) is displayed.

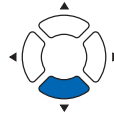
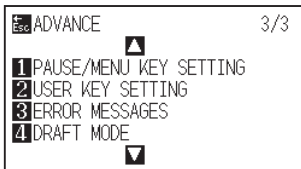

- 4 Press the [1] key (PAUSE/MENU KEY SETTING).

▶ PAUSE/MENU KEY SETTING screen is displayed.

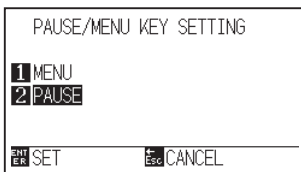

- 5 Press the [1] key (MENU), or the [2] key (PAUSE).

- 6 Confirm the setting and press the [ENTER] key (SET).

▶ Setting will be set, and it will return to ADVANCE setting screen (3/3).

- 7 Press the [PAUSE/MENU] key.

▶ It will return to default screen.

Supplement

It will return to ADVANCE setting screen (3/3) without changing the settings when you press the ESC key (CANCEL).

Setting the user key (USER KEY SETTING)

Set whether to use the switching of the [USER 1/2] key.

Operation

- 1 Press the [PAUSE/MENU] key.

▶ MENU screen is displayed



- 2 Press the POSITION [▼] key (ADV.).

▶ ADVANCE setting screen (1/3) is displayed.

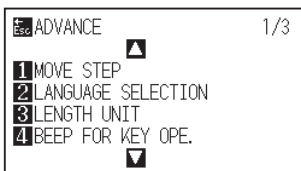

- 3 Press the POSITION (▼) key.

▶ ADVANCE setting screen (3/3) is displayed.

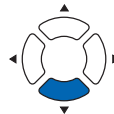
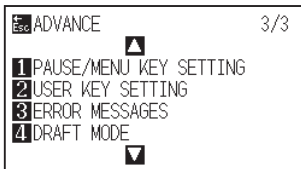

- 4 Press the [2] key (USER KEY SETTING).

▶ USER KEY SETTING setting screen is displayed.

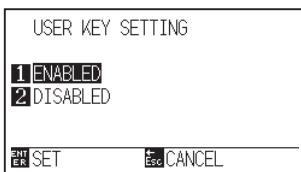

- 5 Press the [1] key (ENABLED), or the [2] key (DISABLED).

- 6 Confirm the setting and press the [ENTER] key (SET).

▶ Setting will be set, and it will return to ADVANCE setting screen (3/3).

- 7 Press the [PAUSE/MENU] key.

▶ It will return to default screen.

Supplement

It will return to ADVANCE setting screen (3/3) without changing the settings when you press the ESC key (CANCEL).

Setting the draft mode (DRAFT MODE)

Set whether to use the draft mode. When the draft mode is enabled, the “D” is displayed in the READY screen and the screen during operation.

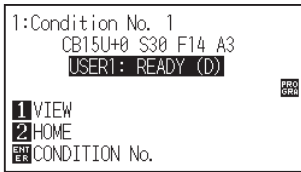

CAUTION

When setting to ENABLED, the cutting operation is faster, but the image quality is not guaranteed.

Operation

- 1 Press the [PAUSE/MENU] key.

▶ MENU screen is displayed



- 2 Press the POSITION [] key (ADV.).

▶ ADVANCE setting screen (1/3) is displayed.

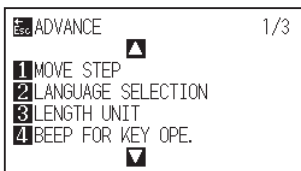

- 3 Press the POSITION () key.

▶ ADVANCE setting screen (3/3) is displayed.

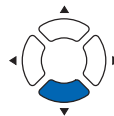
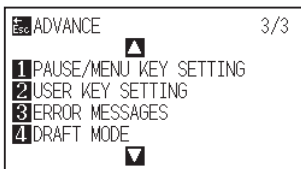

- 4 Press the [4] key (DRAFT MODE).

▶ DRAFT MODE setting screen is displayed.

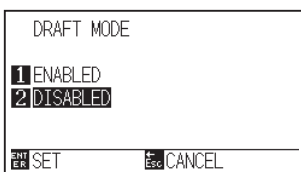

- 5 Press the [1] key (ENABLED), or the [2] key (DISABLED).

- 6 Confirm the setting and press the [ENTER] key (SET).
 - ▶ Setting will be set, and it will return to ADVANCE setting screen (3/3) .
- 7 Press the [PAUSE/MENU] key.
 - ▶ It will return to default screen.

Supplement

It will return to ADVANCE setting screen (3/3) without changing the settings when you press the ESC key (CANCEL).

Chapter 11:

Settings of Controls from Computer

This chapter describes setting regarding the controls from the computer.

Related to Command Processing

Setting the Command (COMMAND)

There are 2 types of commands, the GP-GL and the HP-GL, that the plotter can use.
Match the setting to the used software, or set it to AUTO.

Supplement

- Automatic detection of the command may make mistake depending on the data. It will give error or malfunction when it has made mistake. In that case, set the command before using.
- Always send the data when the plotter is in READY status during the automatic detection of the command.
- Once the data is cut with the automatic detection of the command, it will be ready to automatically detect next command 10 seconds after completing the cutting. Send next data after 10 seconds has past after previous cutting when sending data with different command.

Operation

- 1 Press the [PAUSE/MENU] key in the default screen.

▶ MENU screen is displayed.

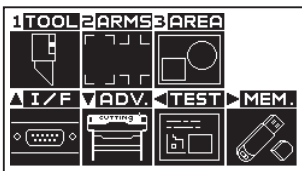

- 2 Press the POSITION (▲) key (I/F).

▶ INTERFACE setting screen (1/3) is displayed.

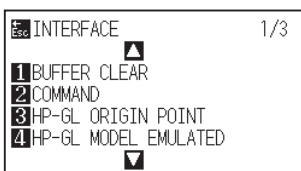

- 3 Press the [2] key (COMMAND).

▶ COMMAND setting screen is displayed

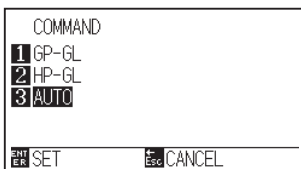

- 4 Select the [1] key (GP-GL), the [2] key (HP-GL), or the [3] key (AUTO).

- 5 Confirm the setting and press the [ENTER] key (SET).

▶ Setting will be set, and it will return to INTERFACE setting screen (1/3).

- 6 Press the [PAUSE/MENU] key.

▶ It will return to default screen.

Supplement

It will return to **INTERFACE** setting screen (1/3) without clearing the buffer when you press the [ESC] key (CANCEL).

Priority of Tool Condition Selection (CONDITION PRIORITY)

Select the priority of the setting created by different method when the tool condition is set.

All the tool condition that is received from the computer will be ignored, and only the setting and change of the tool condition from the control panel is accepted when MANUAL is selected. This setting set here is maintained even if the power is turned off.

On the other hand, it will set the most current tool condition either from the control panel or from the software when PROGRAM is selected. The values set from the control panel is maintained, and the values set from the software is erased when the power is turned off.

Operation

- 1 Press the [PAUSE/MENU] key in the default screen.

▶ MENU screen is displayed.

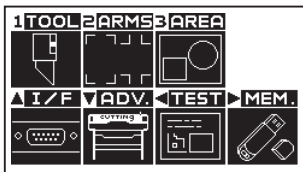

- 2 Press the [1] key (TOOL).

▶ TOOLS SETTING screen (1/4) is displayed.

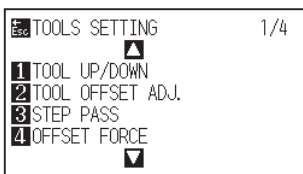

- 3 Press the POSITION (▲) key.

▶ TOOLS SETTING screen (2/4) is displayed.

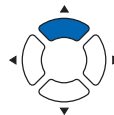
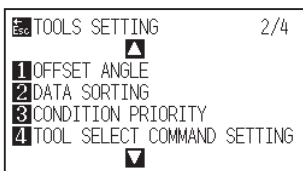

- 4 Press the [3] key (CONDITION PRIORITY).

▶ CONDITION PRIORITY setting screen is displayed.

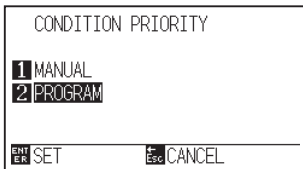

- 5 Press the [1] key (MANUAL) or the [2] key (PROGRAM).

- 6 Confirm the setting and press the [ENTER] key (SET).

▶ Setting will be set, and it will return to TOOLS SETTING screen (2/4).

- 7 Press the [PAUSE/MENU] key.

▶ It will return to default screen.

Supplement

It will return to TOOLS SETTING screen (2/4) without clearing the buffer when you press the [ESC] key (CANCEL).

Enabling/Disabling the Condition Select Command (TOLL SELECT COMMAND)

Setting for what to do when the condition select command ("J" in GP-GL, and "SP" in HP-GL) is received. It will ignore the condition select command when set to DISABLED.

Operation

- 1 Press the [PAUSE/MENU] key in the default screen.

▶ MENU screen is displayed.



- 2 Press the [1] key (TOOL).

▶ TOOLS SETTING screen (1/4) is displayed.

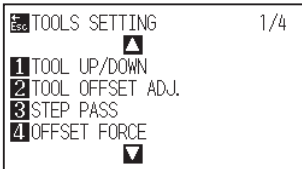

- 3 Press the POSITION (▲) key.

▶ TOOLS SETTING screen (2/4) is displayed.

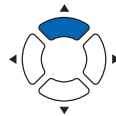
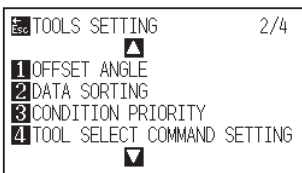

- 4 Press the [4] key (TOOL SELECT COMMAND SETTING).

▶ TOOL SELECT COMMAND SETTING screen is displayed.

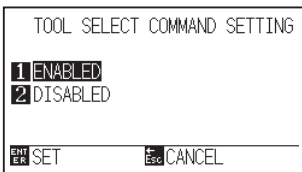

- 5 Press the [1] key (ENABLED) or the [2] key (DISABLED).

- 6 Confirm the setting and press the [ENTER] key (SET).

▶ Setting will be set, and it will return to TOOLS SETTING screen (2/4).

- 7 Press the [PAUSE/MENU] key.

▶ It will return to default screen.

Supplement

It will return to TOOLS SETTING screen (2/4) without clearing the buffer when you press the [ESC] key (CANCEL).

Related to GP-GL Command

This section is useful when using the GP-GL command.

Setting the Step Size (GP-GL STEP SIZE)

The distance to travel with 1 step can be changed. Match the setting value of the application to be used.

Operation

- 1 Press the [PAUSE/MENU] key in the default screen.

▶ MENU screen is displayed.



- 2 Press the POSITION (▲) key (I/F).

▶ INTERFACE setting screen (1/3) is displayed.

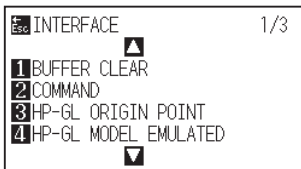

- 3 Press the POSITION (▲) key twice.

▶ INTERFACE setting screen (2/3) is displayed.

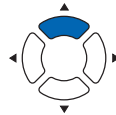
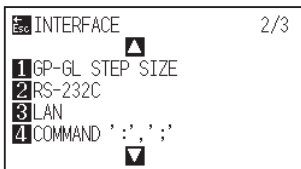

- 4 Press the [1] key (GP-GL STEP SIZE).

▶ GP-GL STEP SIZE setting screen is displayed

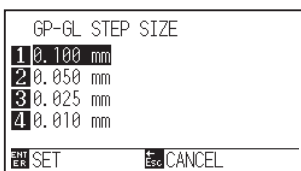

- 5 Press the [1] key (0.100 mm), the [2] key (0.050 mm), the [3] key (0.025 mm), or the [4] key (0.010 mm).

- 6 Confirm the setting and press the [ENTER] key (SET).

▶ Setting will be set, and it will return to INTERFACE setting screen (2/3).

- 7 Press the [PAUSE/MENU] key.

▶ It will return to default screen.

Supplement

It will return to INTERFACE setting screen (2/3) without clearing the buffer when you press the [ESC] key (CANCEL).

Enabling/Disabling the ':', ';' and ',' Commands (COMMAND ':', ';', ',')

If the first part of the data is lost when the GP-GL command is set, these commands may be having an adverse effect. In this case, set the ':', ';' and ',' commands to DISABLED.

Operation

- 1 Press the [PAUSE/MENU] key in the default screen.

▶ MENU screen is displayed.



- 2 Press the POSITION (▲) key (I/F).

▶ INTERFACE setting screen (1/3) is displayed.

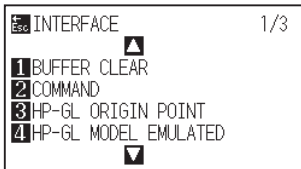

- 3 Press the POSITION (▲) key twice.

▶ INTERFACE setting screen (2/3) is displayed.

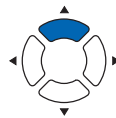

- 4 Press the [4] key (COMMAND ':', ';', ',').

▶ COMMAND ':', ';', ',' setting screen is displayed.

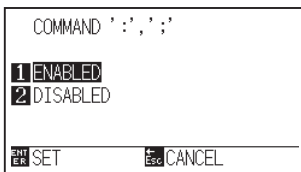

- 5 Press the [1] key (ENABLED) or the [2] key (DISABLED).

- 6 Confirm the setting and press the [ENTER] key (SET).

▶ Setting will be set, and it will return to INTERFACE setting screen (2/3).

- 7 Press the [PAUSE/MENU] key.

▶ It will return to default screen.

Supplement

It will return to INTERFACE setting screen (2/3) without clearing the buffer when you press the [ESC] key (CANCEL).

Moving the Pen While Raised or Lowered in Response to the 'W' Command (COMMAND 'W')

You can set the pen operation when the 'W' command is received, which is a GP-GL arc cutting command.

This function sets the pen operation upon receipt of the 'W' command for the cutting of arcs.

The pen will move to the specified starting position in the raised status when it is set to TOOL UP, regardless of the pen's conditions. The pen will move without changing its condition, to the specified starting position in the lowered status when it is set to TOOL DOWN.

Supplement

This has an effect on the tool cutter only. For the pen setting, always the pen is raised (PEN UP).

Operation

- 1 Press the [PAUSE/MENU] key in the default screen.

▶ MENU screen is displayed.

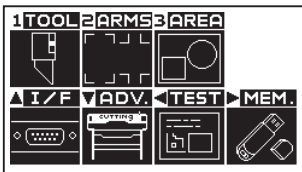

- 2 Press the POSITION (▲) key (I/F).

▶ INTERFACE setting screen (1/3) is displayed.

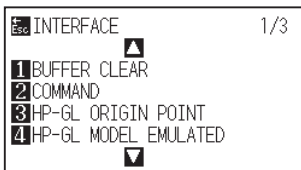

- 3 Press the POSITION (▲) key.

▶ INTERFACE setting screen (3/3) is displayed.

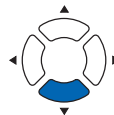
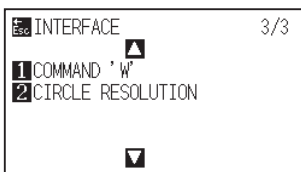

- 4 Press the [1] key (COMMAND 'W').

▶ COMMAND 'W' setting screen is displayed.

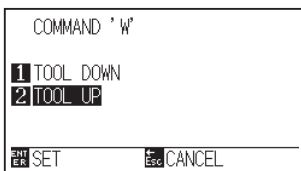

- 5 Press the [1] key (TOOL DOWN) or the [2] key (TOOL UP).

- 6 Confirm the setting and press the [ENTER] key (SET).

▶ Setting will be set, and it will return to INTERFACE setting screen (3/3).

- 7 Press the [PAUSE/MENU] key.

▶ It will return to default screen.

Supplement

It will return to INTERFACE setting screen (3/3) without clearing the buffer when you press the [ESC] key (CANCEL).

Related to HP-GL Command

This section is useful when using the HP-GL command.

Model ID Response (HP-GL MODEL EMULATED)

This function sets the operation upon receipt of the "OI" command requesting for the model ID.

The reply will be 7550 when set to 7550, and 7586 when set to 7586.

Operation

- 1 Press the [PAUSE/MENU] key in the default screen.

▶ MENU screen is displayed.



- 2 Press the POSITION (▲) key (I/F).

▶ INTERFACE setting screen (1/3) is displayed.

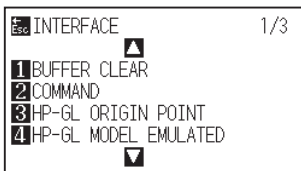

- 3 Press the [4] key (HP-GL MODEL EMULATED).

▶ HP-GL MODEL EMULATED setting screen is displayed.

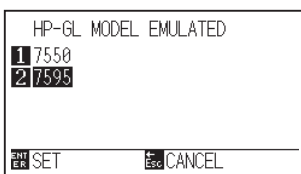

- 4 Press the [1] key (7595) or the [2] key (7586).

- 5 Confirm the setting and press the [ENTER] key (SET).

▶ Setting will be set, and it will return to INTERFACE setting screen (1/3).

- 6 Press the [PAUSE/MENU] key.

▶ It will return to default screen.

Supplement

It will return to INTERFACE setting screen (1/3) without clearing the buffer when you press the [ESC] key (CANCEL).

Setting the Circle-Command Resolution (CIRCLE RESOLUTION)

This function sets the resolution upon receipt of the circle-command for the HP-GL pen plotter arc cutting command.

Select either "AUTO" or "DEFAULT", which is 5 degrees.

Operation

- 1 Press the [PAUSE/MENU] key in the default screen.

▶ MENU screen is displayed.

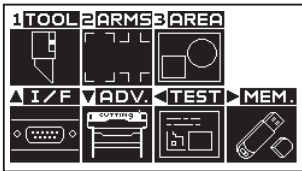

- 2 Press the POSITION (▲) key (I/F).

▶ INTERFACE setting screen (1/3) is displayed.

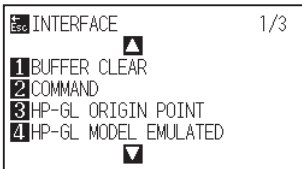

- 3 Press the POSITION (▼) key twice.

▶ INTERFACE setting screen (3/3) is displayed.

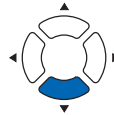
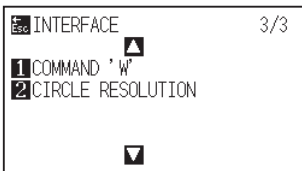

- 4 Press the [2] key (CIRCLE RESOLUTION).

▶ CIRCLE RESOLUTION setting screen is displayed.

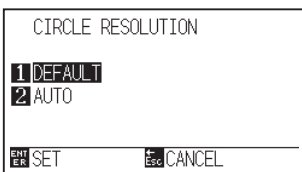

- 5 Press the [1] key (DEFAULT) or the [2] key (AUTO).

- 6 Confirm the setting and press the [ENTER] key (SET).

▶ Setting will be set, and it will return to INTERFACE setting screen (3/3).

- 7 Press the [PAUSE/MENU] key.

▶ It will return to default screen.

Chapter 12: Offline Output

This chapter describes setting regarding the offline output.

PRODUCT SUMMARY

12.1 Offline Output from USB Memory

12.2 Output with a Bar Code

12.1 Offline Output from USB Memory

Dedicated data that was preliminarily created by the application software can be saved in the USB memory and output from the cutting plotter.

Select the data from the menu of the plotter, and then output it in offline.

Supplement

- Only 1-byte alphanumeric characters (ASCII) are supported.
- Limit of the number of display characters is 25 characters. More characters than 25 can be displayed by scrolling.
- Scroll is displayed after a few moments after selecting the item.
- Extension is "xpf" and "plt".
- The folder is surrounded by '<' and '>'.
- Name is sorted in ascending order.
- Files and folders can be obtained up to 64.

Operation

1 Insert the USB memory that saved the dedicated data to the plotter.

2 Press the [PAUSE/MENU] key.

▶ MENU screen is displayed.



3 Press the (▶) key (MEM.).

▶ OFF-LINE OPERATION screen is displayed.

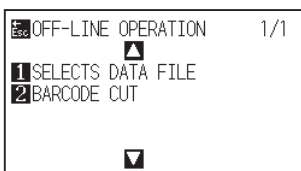

4 Press the [1] key (SELECTS DATA FILE).

▶ SELECTS DATA FILE screen is displayed.



5 Press the POSITION (▲▼) keys and select the file.

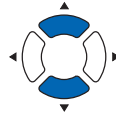

6 Press the [ENTER] key (START).

▶ The selected file is cut off.

7 When the cut-off is finished, it will become READY status.

Supplement

- If the USB memory is not inserted, the following screen is displayed.

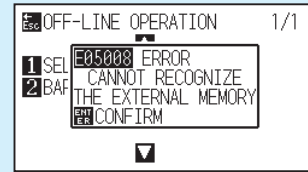

- If the output data is not saved in the USB memory, the following screen is displayed.

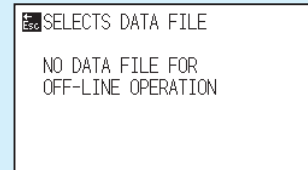

Supplement

Press the POSITION (◀▶) to select the folder.

12.2 Output with a Bar Code

The information related to the output file is preliminarily bar-coded using the Cutting Master4 and Graphtec Pro Studio, etc. and it can be printed with the design and the registration marks.

When cutting with the cutting plotter, the bar code is scanned and the cut data that has been saved to a USB memory that matches the bar code is detected.

Operation

1 Insert the USB memory that saved the dedicated data to the plotter.

2 Press the [PAUSE/MENU] key.

▶ MENU screen is displayed.



3 Press the (▶) key (MEM.).

▶ OFF-LINE OPERATION screen is displayed.

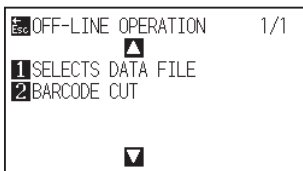

4 Press the [2] key (BARCODE CUT).

▶ The following message is displayed.

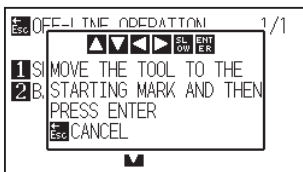

Supplement

- If the USB memory is not inserted, the following screen is displayed.

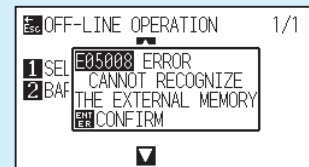

- When the ROTATION is enabled, the following screen is displayed.

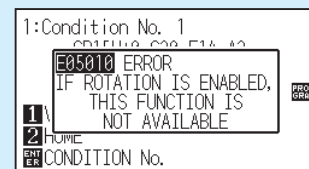

- When the REVERSE CUTTING is enabled, the following screen is displayed.

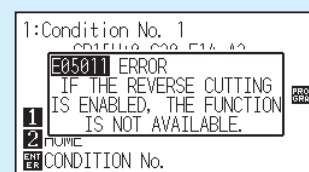

- 5 Press the POSITION (▲▼◀▶) keys and move the tool to the start mark position.

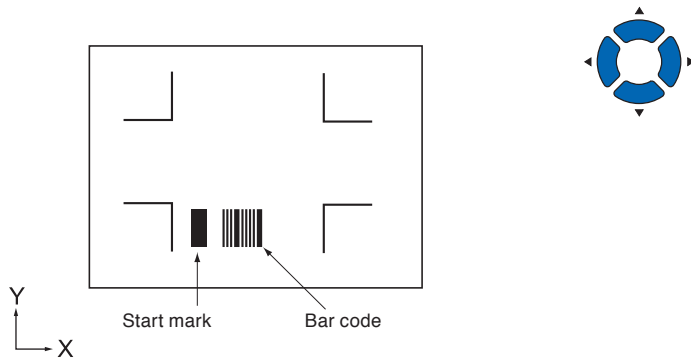

- 6 Confirm the tool position and press [ENTER] key.

▶ The bar code is scanned. When completed, the following screen is displayed.

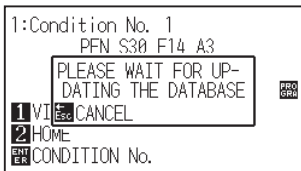

Supplement

- When the start mark is not detected, the following screen is displayed.

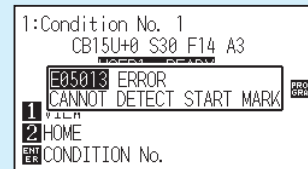

- 7 Find the file, and then start cutting.

Supplement

- If the appropriate files are found, select the proper file.

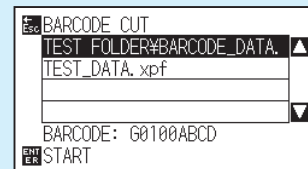

- If the appropriate files is not found, the following screen is displayed.

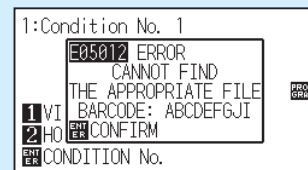

- 8 When completed, it will become READY status.

Chapter 13: Maintenance

This chapter describes the settings for the maintenance.

PRODUCT SUMMARY

- 13.1 Daily Maintenance***
- 13.2 Replacing Cutter Blade***
- 13.3 Cleaning the Cutter Pen***
- 13.4 Replacing the Cutter Plunger***
- 13.5 Setting the Alarm for Degree of Wear
(BLADE WEAR ALARM)***

13.1 *Daily Maintenance*

Daily Maintenance

During the course of daily maintenance be sure to observe the following precautions:

- (1) Never lubricate the mechanisms of the plotter.
- (2) Clean the plotter's casing using a dry cloth that has been moistened in a neutral detergent diluted with water. Never use thinner, benzene, alcohol, or similar solvents to clean the casings; they will damage the casing's finish.
- (3) If the writing panel is dirty, please clean using a dry cloth.
 - * Do not use benzene, thinners, or similar solvents to clean the writing panel.
- (4) When the Y rail sliding surface gets dirty, gently wipe the dirt away with a clean, dry towel.
 - * The sliding surface has lubricant on it, so be sure not to wipe all the lubricant off as well.

Storing the Plotter

When your plotter is not in use, be sure to observe the following points:

- (1) Remove the tool attached to the tool holder.
- (2) Cover the plotter with a cloth to protect it from dust and dirt.
- (3) Do not store the plotter in direct sunlight or in high temperatures.

13.2 Replacing Cutter Blade

Replace the cutter blade by referring to the structure diagram of the cutter pen.

CAUTION

To avoid bodily injury, handle cutter blades with care.

Supplement

For more information about the structure of the Cutter Plunger, see "Cutter Plunger Structure".

Structure of Cutter Plunger

PHP35-CB15-HS
φ1.5 mm diameter cutter Plunger

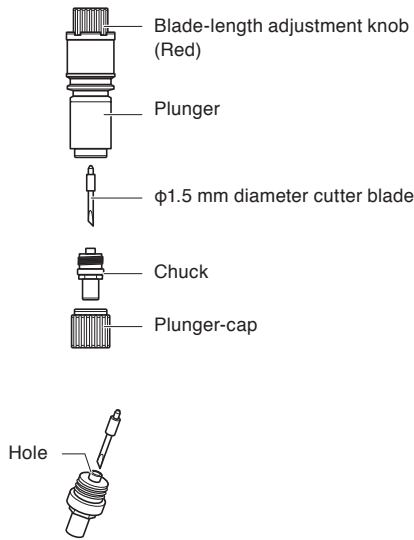

PHP35-CB09-HS
φ0.9 mm diameter cutter Plunger

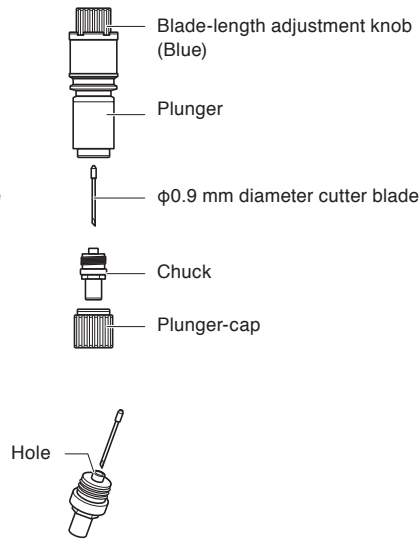

PHP34-CB30-HS
φ3.0 mm diameter cutter Plunger

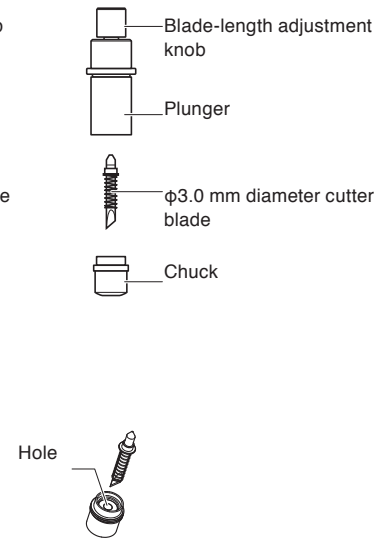

Operation

- 1 Turn the blade-length adjustment knob in the direction of the B arrow and pull the blade into the plunger.

PHP35-CB09-HS/PHP35-CB15-HS

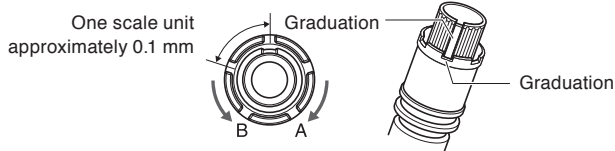

PHP34-CB30-HS

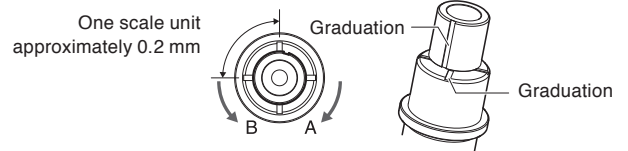

- 2 Turn the plunger cap in the counter-clockwise direction to remove it from the plunger
- 3 Remove the blade from inside the plunger cap.
- 4 Remove a new blade from its pack. Insert the new blade into the hole provided in the plunger cap.

- 5 With the blade inserted into the plunger cap, screw on the plunger from above.
- 6 Fix the plunger cap by turning it clockwise.

 **CAUTION**

- Please fully insert the cutter blade straight into the chuck.

If the cutter blade cannot be inserted straight, please insert the cutter blade after pressing the insertion port of the cutter blade several times.

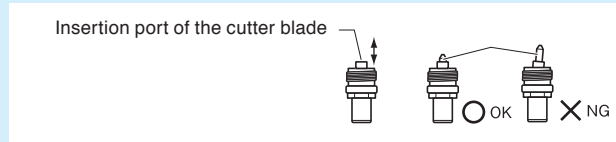

If not installed correctly, it may result in damage to the cutter blade or the plotter itself.

13.3 Cleaning the Cutter Pen

Letting leftover media and paper dust build up on blades can dull them and cause them to deteriorate. Be sure to clean the cutter pen regularly and remove build up.

CAUTION

To avoid bodily injury, handle cutter blades with care.

Operation

- 1 Clean off paper dust and media build up from the blade. After cleaning it, return it to its proper place.

Spin the plunger cap, remove it, and then clean the blade entrance area.

PHP35-CB09-HS/
PHP35-CB15-HS

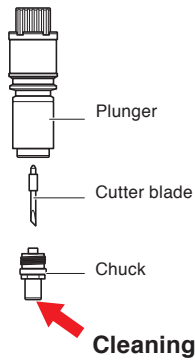

PHP34-CB30-HS

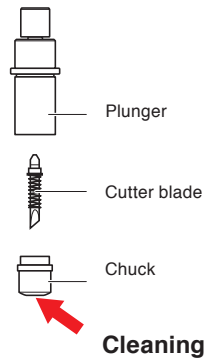

- 2 Attach the plunger cap after the cleaning is finished.

13.4 Replacing the Cutter Plunger

The tip of the cutter plunger gets worn down due to friction with the media.

When the tip of the cutter plunger gets worn down, cut quality suffers.

When the tip of the plunger cap gets worn down, it is recommended that you replace it with the new cutter plunger.

PHP35-CB09-HS/
PHP35-CB15-HS

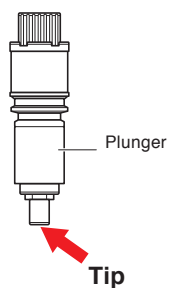

PHP34-CB30-HS

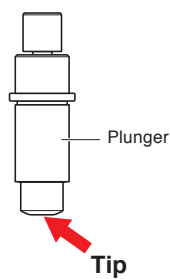

 **CAUTION**

To avoid bodily injury, handle cutter blades with care.

13.5 Setting the Alarm for Degree of Wear (BLADE WEAR ALARM)

This function measures the distance of cuts made by the plotter to determine when the cutter blade should be replaced.

BLADE WEAR DETECT ON/OFF, SET BLADE GROUP, ALARM DISTANCE and BLADE WEAR DETECT settings are required.

Operation

- 1 Press the [PAUSE/MENU] key in the default screen.

▶ MENU screen is displayed.



- 2 Press the [1] key (TOOL).

▶ TOOLS SETTING screen (1/4) is displayed.

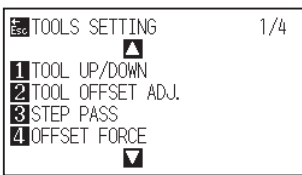

- 3 Press the POSITION (▼) key.

▶ TOOLS SETTING screen (4/4) is displayed.

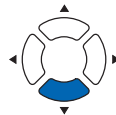
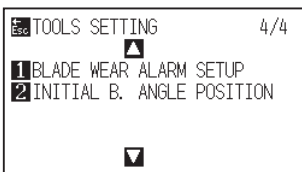

- 4 Press the [1] key (BLADE WEAR ALARM SETUP).

▶ BLADE WEAR ALARM SETUP setting screen is displayed.

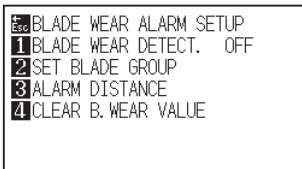

- 5 Press the [1] key (BLADE WEAR DETECT. OFF).

▶ BLADE WEAR DETECT setting screen is displayed.



Supplement

It will return to TOOLS SETTING screen (4/4) without changing the settings when you press the [ESC] key (BLADE WEAR ALARM SETUP).

6 Press the [1] key (ON) or the [2] key (OFF).

7 Confirm the setting and press the [ENTER] key (SET).

▶ Setting will be set, and it will return to BLADE WEAR ALARM SETUP screen.

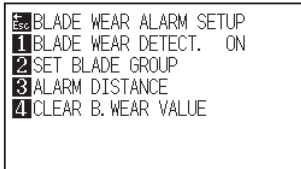

8 Press the [2] key (SET BLADE GROUP).

▶ SET BLADE GROUP setting screen is displayed.

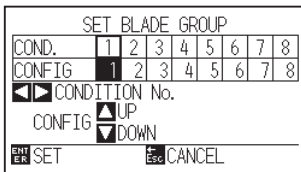

9 Press the POSITION (◀▶) keys and select the tool condition No. (CONDITION NO.).

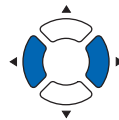

Supplement

Setting range is 1 to 8.

10 Press the POSITION (▲▼) key and increase or decrease the setting value.

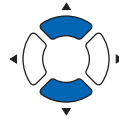

Supplement

Setting range is 1 to 8.
When set to 0, the alarm will not belong to any group.

11 Confirm the setting and press the [ENTER] key (SET).

▶ Setting will be set, and it will return to BLADE WEAR ALARM SETUP screen.

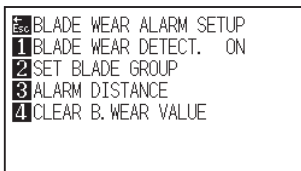

12 Press the [3] key (ALARM DISTANCE).

▶ ALARM DISTANCE setting screen is displayed.

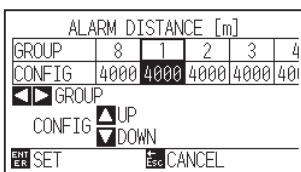

13 Press the POSITION (◀▶) keys and select the group No. (GROUP NO.).

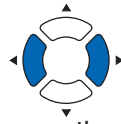

Supplement

Setting range is 0 to 8..

14 Press the POSITION (▲▼) key and increase or decrease the setting value.

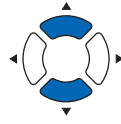

Supplement

Setting range is 500 m to 5000 m (100 m step)

15 Confirm the setting and press the [ENTER] key (SET).

▶ Setting will be set, and it will return to BLADE WEAR ALARM SETUP screen.

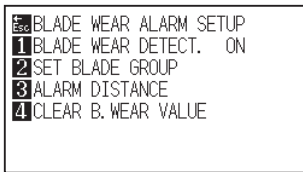

16 Press the [4] key (CLEAR B. WEAR VALUE).

▶ CLEAR B. WEAR VALUE setting screen is displayed.

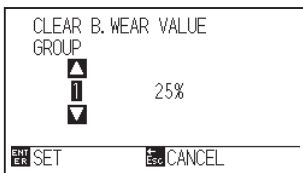

17 Press the POSITION (▲▼) keys and select the group No. (GROUP NO.).

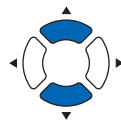

18 Confirm the setting and press the [ENTER] key (SET).

▶ CLEAR? screen is displayed.

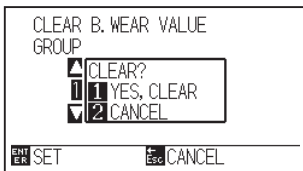

Supplement

It will return to CLEAR B. WEAR VALUE setting screen without clearing the blade wear value when you press the [2] key (CANCEL).

19 Press the [1] key (Yes, CLEAR).

▶ Blade wear value will be cleared and it will return to CLEAR B. WEAR VALUE setting screen.

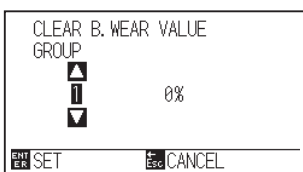

20 Press the [ESC] key (CANCEL).

- ▶ Setting will be set, and it will return to BLADE WEAR ALARM SETUP setting screen.

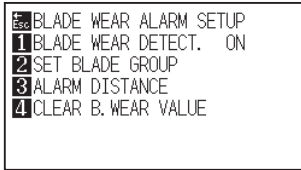

21 Press the [PAUSE/MENU] key

- ▶ It will return to default screen.

Chapter 14: Troubleshooting

Refer to this chapter if you feel something is wrong, or it does not work right.

It also describes the settings of the plotter, confirming the cutting data, and method to create test patterns.

PRODUCT SUMMARY

- 14.1 *Troubleshooting***
- 14.2 *Printing the Setting of the Plotter***
- 14.3 *Plotting the Test Pattern***
- 14.4 *Plotting the CUTTING PRO***
- 14.5 *Confirming the Cutting Data***
- 14.7 *Plotting the Sample Cut Pattern***
- 14.7 *Self Diagnostic Test***

14.1 Troubleshooting

When the Plotter Does Not Operate After Turning the Power On

Symptom	Possible Cause	Solution
<ul style="list-style-type: none">• Nothing is displayed on the LCD panel.	There is no power supplied. Or, the plotter is defective.	Check that the power cord is securely connected to the plotter's AC line inlet and the electrical outlet. Check that the power is supplied to the electrical outlet. Contact your Graphtec customer center if the problem still exists.
<ul style="list-style-type: none">• Nothing is displayed on the LCD panel.	The plotter is defective.	Contact your Graphtec customer center if the problem still exists.
<ul style="list-style-type: none">• "Sum-Ck ROM RAM ERR!!" is displayed on the LCD panel.	The ROM or RAM is defective.	Contact your Graphtec customer center if the problem still exists.

When It Does Not Work Right

Symptom	Possible Cause	Solution	Reference
<ul style="list-style-type: none"> The plotter stops with "POSITION ALARM" displayed during initialization or cutting. 	CONDITION setting for the media is invalid.	Slow down the speed or lower the FORCE.	Setting the Tool Condition
	The pen carriage does not move by hitting something.	Move the object disturbing the operation, and turn on the plotter after turning it off once	
	External force is applied to the pen carriage while cutting.	Move the object disturbing the operation, and turn on the plotter after turning it off once.	
	Movement is disturbed by the media chaff in the operation area.	Move the object disturbing the operation, and turn on the plotter after turning it off once.	
	The plotter is defective.	Contact your sales representative or the Graphtec call center.	
<ul style="list-style-type: none"> It is cutting with origin point shifting to center of the media. 	Data created with lower left origin point is received when the plotter is set with center origin point. (With HP-GL command)	Reset the origin point to center on the application software, or reset the origin point of the plotter to lower left.	Setting Origin Point When HPGL is Set
<ul style="list-style-type: none"> Displays command error. 	Data sent to the plotter is not correct.	Check the data.	Error Message in GP-GL Command Mode Error Message in HP-GL Command Mode
<ul style="list-style-type: none"> There are too many tool up and down. 	Setting for the tangential mode is set to ON.	Turn OFF the setting for the tangential mode unless you are cutting thick media.	Setting the TANGENTIAL MODE
<ul style="list-style-type: none"> Cannot change the tool condition. 	Setting for the sorting is set to ON.	Normally, use the plotter with setting for the sorting OFF.	Sorting the Cutting Data
<ul style="list-style-type: none"> Tool condition changes. 	Setting of the priority is set to PROGRAM.	Change the setting of the priority to MANUAL.	Priority of Tool Condition Selection (CONDITION PRIORITY)
	The [ENTER] key is not pressed after changing the TOOL CONDITION.	Check the TOOL CONDITION again.	Setting the Tool Condition
<ul style="list-style-type: none"> It does not become specified length. (Slight distance error) 	Distance adjust value is not correct.	Perform distance adjust.	Setting the Distance Adjust

When the Cutting Result is Not Good

Symptom	Possible Cause	Solution
<ul style="list-style-type: none"> • Corners are rounded. • Corners are too sharp. 	Blade and OFFSET does not match.	Change the OFFSET. → It is rounded: Increase the OFFSET → It is too sharp: Decrease the OFFSET
<ul style="list-style-type: none"> • The cut line starts out crooked. 	The blade inside the plunger doesn't turn smoothly.	Remove dirt from inside the plunger.
<ul style="list-style-type: none"> • The blade skips and does not completely cut lines that should be solid. • Straight cut lines seems to wobble. 	The blade is extended too far.	Adjust the blade length.
	The cutting speed is too high.	Lower the speed setting.
<ul style="list-style-type: none"> • Coarse resolution of curved lines. 	The software's resolution setting is too low.	Adjust the software's resolution setting.
	The blade offset angle is too low.	Increase the value for the blade offset angle.
<ul style="list-style-type: none"> • The media curls up at the corners. • Fine cut characters peels off. 	The blade is extended too far.	Adjust the blade length.
	Blade and OFFSET does not match.	Change the OFFSET.
	The cutting speed is too high.	Lower the speed setting.
	The blade is dull.	Replace the blade.
	The ACCELERATION setting is too high.	Lower the ACCELERATION setting.
<ul style="list-style-type: none"> • The blade is cutting into the backing sheet. 	The blade is extended too far.	Adjust the blade length.
	The cutting FORCE is too high.	Lower the FORCE setting.
<ul style="list-style-type: none"> • The blade falls out of the plunger. 	The blade is too small for the plunger.	Use a blade that fits securely in the plunger.
<ul style="list-style-type: none"> • Media can be cut but it is hard to weed afterwards. • Cut media cannot be pulled up using retack sheet. 	The retack sheet is not sticky enough.	Switch to a stickier retack sheet.
	Media gets entangled during cutting.	Reduce the blade length. Lower the FORCE setting.
	Cleaning of cut media was postponed too long.	Promptly weed cut media.
<ul style="list-style-type: none"> • Abnormal noise generated from the tool carriage during cutting. • The media is discolored where the blade has passed. 	Media is rubbed by the tip of the plunger.	Adjust the blade length and the cutting FORCE settings.
	<ul style="list-style-type: none"> • The cutting results differ from the specified size. 	The STEP SIZE has been set differently at the computer and the plotter. Scaling has been specified on the computer.
<ul style="list-style-type: none"> • Currently selected cutting conditions are disregarded or cannot be changed. 	The parameter priority setting is set to PROGRAM.	Change the setting of the priority to MANUAL.
	The [ENTER] key was not pressed after changing the settings.	Check the operation.
<ul style="list-style-type: none"> • Characters or lines are deformed during pen plotting. 	The plotter is in cutting mode.	Select PEN as the tool in the CONDITION setting.
<ul style="list-style-type: none"> • It does not become specified length. (Slight distance error) 	Distance adjust value is not correct.	Perform distance adjust.
<ul style="list-style-type: none"> • Characters are deformed. • Complex drawings are deformed. 	The STEP PASS setting is set too high.	Lower the STEP PASS setting.
<ul style="list-style-type: none"> • The starting and end points of cutting do not match. 	Coordinate points are incorrectly specified.	Check the coordinate data by plotting it with a pen.
	The media backing is too flimsy.	Switch to a media with a stronger backing.
	Blade rotation is not smooth.	Check that there is no dirt in the blade.

Error Messages in GP-GL Command Mode

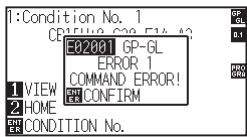
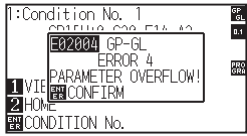
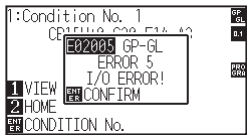
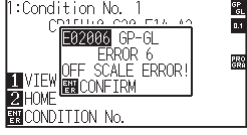
Error Displayed	LCD Display	Cause	Solution
E02001		• The plotter received an unrecognizable command.	Press the [ENTER] key.
		• Noise came in when the computer was turned on.	Configure to drive the plotter from the menu of the software.
		• The software configuration regarding the output device has been changed.	Reset the interface settings of the software.
		• The plotter's interface conditions have changed.	Reset the interface settings of the plotter.
E02004		• A command was received containing numeric parameters that exceed that command's permissible range.	Configure to drive the plotter from the menu of the software.
		• The software configuration regarding the output device has been changed.	Reset the interface settings of the software.
		• The plotter's interface conditions have changed.	Reset the interface settings of the plotter.
E02005		• An error occurred in the receipt of data within the interface.	Configure to drive the plotter from the menu of the software.
		• The software configuration regarding the output device has been changed.	Reset the interface settings of the software.
		• The plotter's interface conditions have changed.	Reset the interface settings of the plotter.
E02006		• The data out of cutting range has been received.	Check the data.
			Check the size of media and the cutting range.
			Check the magnification setting.
			Check the step size settings.

Error Messages in HP-GL Command Mode

If any of the following command errors occur, they are nearly always caused by following 2 reasons.

1. The configuration regarding the output device in the application software has changed.
2. The plotter's interface conditions have changed.

Perform following if these are the cause of the problem.

1. Reconfigure the output device of the application software to the plotter.
2. Reset the plotter's interface conditions.

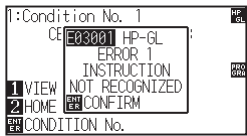
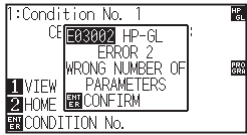
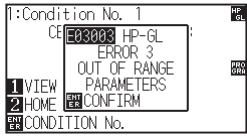
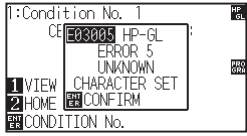
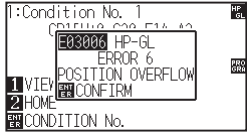
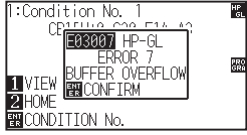
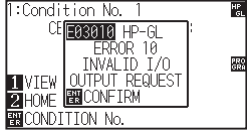
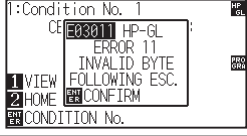
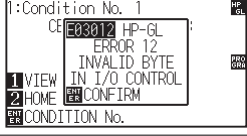
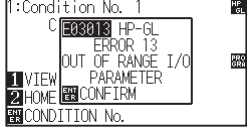
Error Displayed	LCD Display	Cause	Solution
E03001		An unrecognizable instruction was executed.	Execute a recognizable command.
E03002		Wrong number of parameters were specified.	Execute the command with the correct number of parameters.
E03003		An unusable parameter was executed.	Execute a recognizable parameter.
E03005		An unusable character set was specified.	Specify usable character set.
E03006		Coordinates of command specified out of cutting area.	Execute coordinates within the cutting area.
E03007		The data being input exceeds the capacity of the plotter's downloadable character buffer, polygon buffer, etc.	Adjust the buffer size.
E03010		Other output command was executed while executing an output command.	Check the program.
E03011		An invalid byte was received after ESC code.	Check the program.
E03012		Invalid byte was received within device control command.	Check the program.
E03013		A parameter outside of the permissible range was specified in the I/O related command.	Check the program.

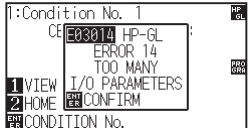
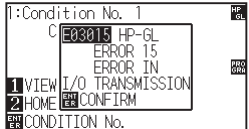
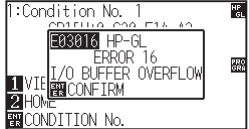
Error Displayed	LCD Display	Cause	Solution
E03014		Too many parameters in the I/O related command.	Check the program.
E03015		Framing error, parity error, or overrun error has occurred.	Set the RS-232C transmission condition.
E03016		Interface buffer memory has overflowed.	Set the RS-232C transmission condition.





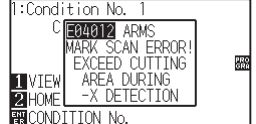
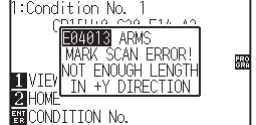
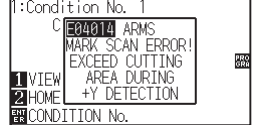
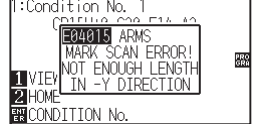
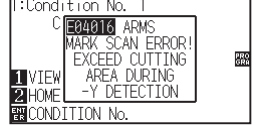
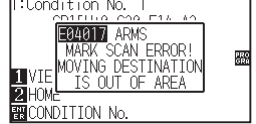
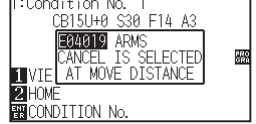
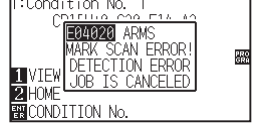
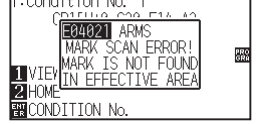
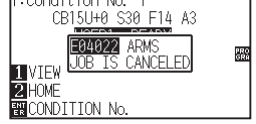
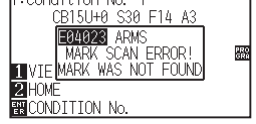

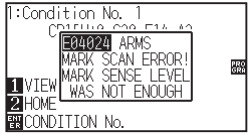
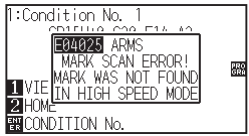

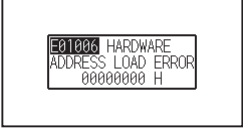

ARMS Error Messages



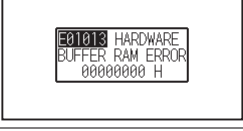

Error Displayed	LCD Display	Cause	Solution
E04001		Tilt to adjust with AXIS ALIGNMENT is too large.	Reload the media.
E04002		It is over the setting range of the distance adjust.	Reset to smaller value.
E04003		Failed to adjust the sensor level.	This media cannot be used.
E04004		It is over the setting range of the distance adjust.	Reset to smaller value.
E04005		Could not scan the registration marks.	Check the registration scan position.
E04006		Amount of data has exceeded the I/O buffer size for the segment area registration mark.	Decrease the data.
E04007		Test pattern plotting position is not within the plotting area for sensor position adjustment.	Move the media toward center and plot the test pattern.
E04009		It has exceeded detection area while detecting the registration mark.	Check the media. Check the print position of the registration mark.
E04010		It has exceeded detection area while detecting the registration mark.	Check the media. Check the print position of the registration mark.
E04011		It has exceeded detection area while detecting the registration mark.	Check the media. Check the print position of the registration mark.

Error Displayed	LCD Display	Cause	Solution
E04012		It has exceeded detection area while detecting the registration mark.	Check the media. Check the print position of the registration mark.
E04013		It has exceeded detection area while detecting the registration mark.	Check the media. Check the print position of the registration mark.
E04014		It has exceeded detection area while detecting the registration mark.	Check the media. Check the print position of the registration mark.
E04015		It has exceeded detection area while detecting the registration mark.	Check the media. Check the print position of the registration mark.
E04016		It has exceeded detection area while detecting the registration mark.	Check the media. Check the print position of the registration mark.
E04017		It has exceeded detection area while detecting the registration mark.	Check the media. Check the print position of the registration mark.
E04019		There was cancel operation by the user.	Redo the process.
E04020		There is a defect in the detection settings value.	Check the settings value.
E04021		Registration mark was not detected in the auto detection area.	Check the media. Check the print position of the registration mark.
E04022		There was cancel operation by the user.	Redo the process.
E04023		Registration mark was not detected.	Redo the sensor level adjustment. Change the color of the registration mark. Check the media. Check the print position of the registration mark.

Error Displayed	LCD Display	Cause	Solution
E04024	 <p>1:Condition No. 1 E04024 ARMS MARK SCAN ERROR! MARK SENSE LEVEL WAS NOT ENOUGH 1 VIEW 2 HOME ERR CONDITION No.</p>	Registration mark was not detected.	Redo the sensor level adjustment. Change the color of the registration mark. Check the media. Check the print position of the registration mark.
E04025	 <p>1:Condition No. 1 E04025 ARMS MARK SCAN ERROR! MARK WAS NOT FOUND IN HIGH SPEED MODE 1 VIEW 2 HOME ERR CONDITION No.</p>	Registration mark was not detected.	Redo the sensor level adjustment. Change the color of the registration mark. Check the media. Check the print position of the registration mark.

Other Error Messages

Error Displayed	LCD Display	Cause	Solution
E01001 to E01005		The plotter is defective.	Contact your sales representative or the Graphtec call center.
E01006		The plotter is defective.	Contact your sales representative or the Graphtec call center.
E01007		The plotter is defective.	Contact your sales representative or the Graphtec call center.
E01008		The plotter is defective.	Contact your sales representative or the Graphtec call center.
E01009		The plotter is defective.	Contact your sales representative or the Graphtec call center.
E01010		The plotter is defective.	Contact your sales representative or the Graphtec call center.
E01011		The plotter is defective.	Contact your sales representative or the Graphtec call center.
E01012		The plotter is defective.	Contact your sales representative or the Graphtec call center.
E01013		The plotter is defective.	Contact your sales representative or the Graphtec call center.
E01014		The plotter is defective.	Contact your sales representative or the Graphtec call center.
E01015		The plotter is defective.	Contact your sales representative or the Graphtec call center.
E01017		The plotter is defective. Load on the motor was too large.	Move the object disturbing the operation, and turn on the plotter after turning it off once.

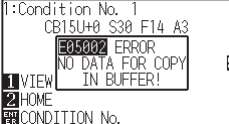
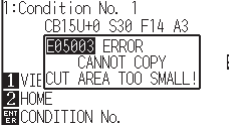
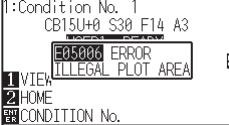
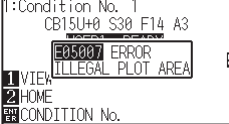
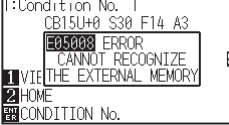
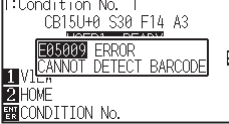
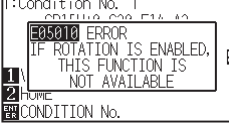
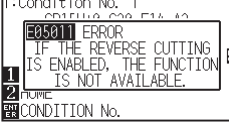
Error Displayed	LCD Display	Cause	Solution
E01019		The plotter is defective. Load on the motor was too large.	Move the object disturbing the operation, and turn on the plotter after turning it off once.
E01021		The plotter is defective. Load on the motor was too large.	Move the object disturbing the operation, and turn on the plotter after turning it off once.
E01022		The plotter is defective. There was a heavy load on the up and down function of the tool carriage.	Please clear any obstruction in the up and down function of the tool carriage and turn the power back on. If the error display continues to show, please contact the store where you bought the product or our Customer Center.
E05001		Data larger than the buffer size cannot be copied.	Perform normal cutting not using the copy mode.
E05002		There is no data to copy.	Perform normal cutting by sending the data, then use the copy mode.
E05003		Media valid area to copy is too small.	Use larger media. Confirm the copy start position.
E05006		Distance between the bottom left and top right of the AREA setting is less than 10 mm.	Perform the AREA setting again.
E05007		Test pattern for the TOOL OFFSET ADJ. cannot start plotting because the start position is at the edge of the media.	Set the start position inside the media.
E05008		The external memory (USB memory) is not recognized.	Insert the external memory (USB memory).
E05009		The bar code is not detected.	Check at the printing state of bar code and set the proper bar code settings.
E05010		When the ROTATION is enabled, the bar code cutting function is not available.	Set the ROTATION to Disabled to use this bar code cutting function.
E05011		When the REVERSE CUTTING is enabled, the bar code cutting function is not available.	Set the REVERSE CUTTING to Disabled to use this bar code cutting function.

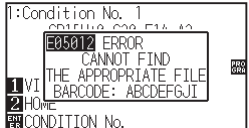
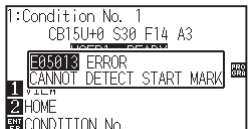
Error Displayed	LCD Display	Cause	Solution
E05012		The appropriate file cannot be found in the external memory (USB memory).	Save the appropriate file in the external memory (USB memory).
E05013		The START MARK is not recognized.	Change the printing state of bar code. Move the tool carriage above the START MARK.

Caution Message

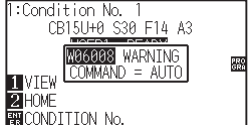
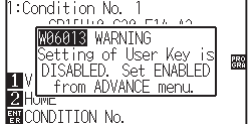
Error Displayed	LCD Display	Description
W06008		When command is set to auto, the DUMP mode is not available.
W06013		The USER KEY is enabled.

14.2 Printing the Setting of the Plotter

Condition setting list can be printed when you need to check the current setting of the plotter.

CAUTION

- Do not place your hand around the moving areas. The tool carriage will start moving, so there is a chance of injury. Tool carriage will start to move immediately after selecting to print the CONDITION list
- Once you start printing, pause/cancel can not be performed in the middle.

Operation

1 Set a media larger than A3 size.

Supplement

See "Loading Media " for loading the media.

2 Set the pen tool to the tool holder and select the condition where the pen tool is set.

Supplement

- See "Attaching a Tool" for setting the pen tool.
- For changing the tool conditions please refer to "Selecting Tool Condition", and for tool settings please refer to "Setting the Tool"..

3 Press the [PAUSE/MENU] key in the default screen.

▶ MENU screen is displayed.



4 Press the POSITION (◀) key (TEST).

▶ TEST menu screen (1/2) is displayed.

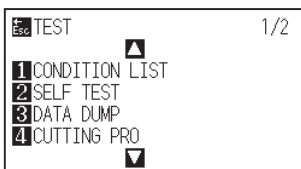

5 Press the [1] key (CONDITION LIST).

▶ CONDITION LIST print screen is displayed.

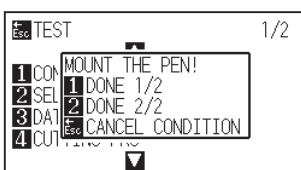

6 Press the [1] key (DONE 1/2) or the [2] key (DONE 2/2).

▶ Message to confirm tool position is displayed.

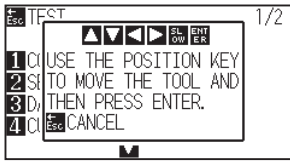

Supplement

Press the [ESC] key (CANCEL CONDITION) to return to the TEST menu screen without printing the list.

7 Press the POSITION (▲▼◀▶)keys and move the tool carriage to print start position.

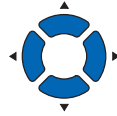

8 Confirm that moving parts of the tool and media can safely operate and press the [ENTER] key.

▶ Selected page of the CONDITION LIST is printed.

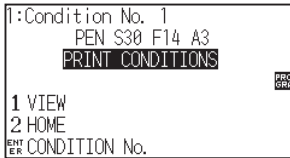

CAUTION

Do not place your hand around the moving areas. The tool carriage will start moving, so there is a chance of injury.

9 When the printing is finished, it will return to READY status.

Supplement

Set the media and repeat steps 6 to 8 to print different page at this point.

14.3 Plotting the Test Pattern

To check the operation of the plotter, plot a self-test pattern.

⚠ CAUTION

Do not place your hand around the moving areas. The tool carriage will start moving, so there is a chance of injury. Tool carriage will start to move immediately after selecting to plot the test pattern.

Operation

1 Set a media larger than A3 size.

Supplement

See "Loading Media " for loading the media.

2 Set the pen tool to the tool holder and select the condition where the pen tool is set.

Supplement

- See "Attaching a Tool" for setting the pen tool.
- For changing the tool conditions please refer to "Selecting Tool Condition", and for tool settings please refer to "Setting the Tool"..

3 Press the [PAUSE/MENU] key in the default screen.

▶ MENU screen is displayed.



4 Press the POSITION (◀) key (TEST).

▶ TEST menu screen (1/2) is displayed.

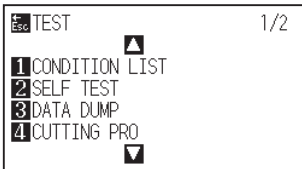

5 Press the [2] key (SELF TEST).

▶ SELF TEST start screen is displayed.

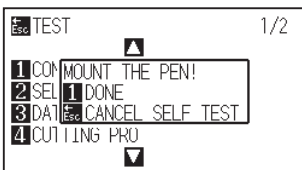

- 6 Confirm that the pen tool is set.
- 7 Confirm that moving parts of tool and media are safely operated.

 **CAUTION**

Do not place your hand around the moving areas. The tool carriage will start moving, so there is a chance of injury.

- 8 Press the [1] key (DONE).
- ▶ Plotting of the test pattern starts.

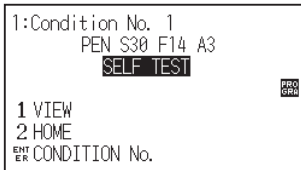

Supplement

It will return to TEST menu screen without printing when you press the [2] key (CANCEL SELF TEST).

- 9 Turn the power off to stop the printing.

Supplement

It will keep on printing until the power is turned off once the printing is started by pressing the [1] key (DONE).

14.4 Plotting the CUTTING PRO

To check the operation of the plotter, plot a test pattern.

⚠ CAUTION

Do not place your hand around the moving areas. The tool carriage will start moving, so there is a chance of injury. Tool carriage will start to move immediately after selecting to plot the test pattern.

Operation

- 1 Set a media larger than A3 size.

Supplement

See "Loading Media " for loading the media.

- 2 Set the tool to the tool holder and select the condition where the tool is set.

Supplement

- See "Attaching a Tool" for setting the tool.
- For changing the tool conditions please refer to "Selecting Tool Condition", and for tool settings please refer to "Setting the Tool"..

- 3 Press the [PAUSE/MENU] key in the default screen.

▶ MENU screen is displayed.



- 4 Press the POSITION (◀) key (TEST).

▶ TEST menu screen (1/2) is displayed.

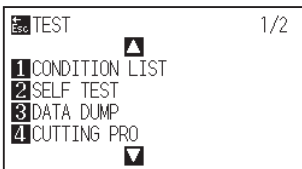

- 5 Press the [4] key (CUTTING PRO).

▶ CUTTING PRO start screen is displayed.

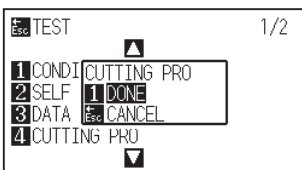

- 6 Confirm that the pen tool is set.
- 7 Confirm that moving parts of tool and media are safely operated.
- 8 Press the [1] key (DONE).
 - ▶ Plotting of the CUTTING PRO starts.
- 9 After the completion of print, the TEST menu screen (1/2) is displayed.
- 10 Press the [PAUSE/MENU] key.
 - ▶ It will return to default screen.

 **CAUTION**

Do not place your hand around the moving areas. The tool carriage will start moving, so there is a chance of injury.

Supplement

It will return to TEST menu screen without printing when you press the [ESC] key (CANCEL SELF TEST).

14.5 Confirming the Cutting Data

Output of the dump list of the cutting data received by the plotter is possible. It is used to check if the transmission of cutting data is performed correctly.

CAUTION

Do not place your hand around the moving areas. The tool carriage will start moving, so there is a chance of injury. Tool carriage will start to move immediately after selecting to print the dump list.

Supplement

- There may be a difference in the RS-232C transmission condition or the command setting when the printed output and the display of transmission data does not match. Check the transmission condition and the command.
- If the command setting is "Auto", the dump list of the cutting data is not output. Please set the command to "GP-GL" or "HP-GL".

Operation

- 1 Set a media larger than A4 size.

Supplement

See "Loading Media " for loading the media.

- 2 Set the pen tool to the tool holder and select the condition where the pen tool is set.

Supplement

- See "Attaching a Tool" for setting the pen tool.
- For changing the tool conditions please refer to "Selecting Tool Condition", and for tool settings please refer to "Setting the Tool"..

- 3 Press the [PAUSE/MENU] key in the default screen.

▶ MENU screen is displayed.



- 4 Press the POSITION (◀) key (TEST).

▶ TEST menu screen (1/2) is displayed.

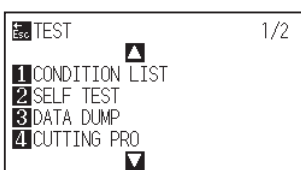

5 Press the [3] key (DATA DUMP).

▶ DATA DUMP start screen is displayed.

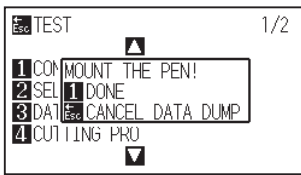

6 Confirm that the pen tool is set.

7 Confirm that moving parts of tool and media are safely operated.

CAUTION

Do not place your hand around the moving areas. The tool carriage will start moving, so there is a chance of injury.

8 Press the [1] key (DONE).

▶ Transmit the data from the computer. A character dump list is printed.

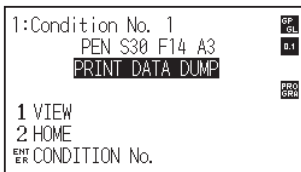

Supplement

It will return to TEST menu screen without printing when you press the [ESC] key (CANCEL DATA DUMP).

9 Turn the power off to stop the printing.

Supplement

It will keep on printing until the power is turned off once the printing is started by pressing the [1] key (DONE).

14.7 Plotting the Sample Cut Pattern

To check the operation of the plotter, plot a sample cut pattern.

⚠ CAUTION

Do not place your hand around the moving areas. The tool carriage will start moving, so there is a chance of injury. Tool carriage will start to move immediately after selecting to print the dump list.

Operation

- 1 Set the media to cut a sample pattern.

Supplement

See "Loading Media " for loading the media.

- 2 Set the tool to the tool holder and select the condition where the tool is set.

Supplement

- See "Attaching a Tool" for setting the pen tool.
- For changing the tool conditions please refer to "Selecting Tool Condition", and for tool settings please refer to "Setting the Tool"..

- 3 Press the [PAUSE/MENU] key in the default screen.

▶ MENU screen is displayed.

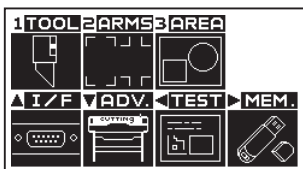

- 4 Press the POSITION (◀) key (TEST).

▶ TEST menu screen (1/2) is displayed.

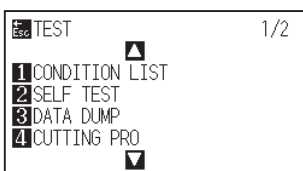

- 5 Press the POSITION (▲) key (TEST).

▶ TEST menu screen (2/2) is displayed.

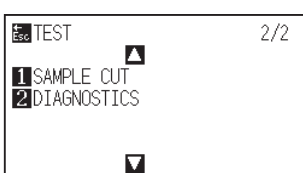

6 Press the [1] key (SAMPLE CUT).

▶ SAMPLE CUT screen is displayed.

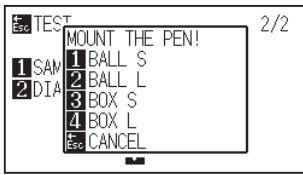

7 Confirm that the tool is set.

8 Confirm that moving parts of tool and media are safely operated.

9 Press any of [1] to [4] keys to perform the sample cut.

▶ Plotting of the sample cut starts.

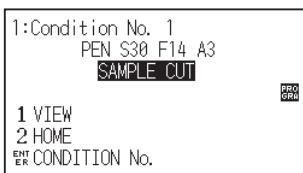

10 When the printing is finished, it will return to READY status.

Supplement

The contents of the sample cut screen depend on the command setting.

CAUTION

Do not place your hand around the moving areas. The tool carriage will start moving, so there is a chance of injury.

Supplement

It will return to TEST menu screen without plotting when you press the [ESC] key (CANCEL).

14.7 Self Diagnostic Test

Operation status can be tested by self diagnostic test by operating the sensors and switches following the instruction on the screen.

Operation

- 1 Confirm that the power is turned off.
- 2 Turn the power on without loading the media.
- 3 Press the [PAUSE/MENU] key in the default screen.

▶ MENU screen is displayed.

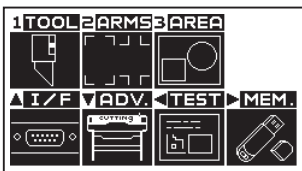

- 4 Press the POSITION (◀) key (TEST).

▶ TEST menu screen (1/2) is displayed.

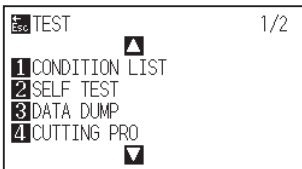

- 5 Press the POSITION (▲) key.

▶ TEST menu screen (2/2) is displayed.

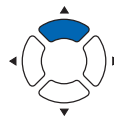
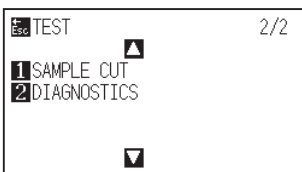

6 Press the [2] key (DIAGNOSTICS).

▶ DIAGNOSTICS start screen is displayed.

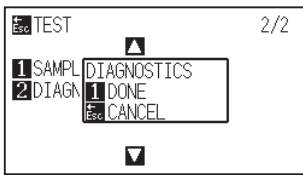

7 Press the [1] key (DONE).

▶ Message for testing is displayed on the screen.

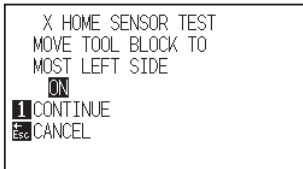

8 Operate switches and sensors following the instructions on the screen.

▶ "OK" will be displayed if the operation is detected correctly, and next test will start.

▶ It will return to TEST menu screen once all the test items are completed.

Test items are as following.

1	X Home sensor	2	Y motor signal	3	X motor signal	4	Y motor signal
5	Tool 1 height signal	6	Tool 2 height signal	7	[1] key	8	[2] key
9	[3] key	10	[4] key	11	[USER 1/2] key	12	[SLOW] key
13	POSITION [▲] key	14	POSITION [◀] key	15	POSITION [▼] key	16	POSITION [▶] key
17	[PAUSE/MENU] key	18	[COND/TEST] key	19	[ORIGIN] key	20	[COPY] key
21	[ESC] key	22	[ENTER] key				

Reading the Error Message

Contents of most current 32 errors can be checked. Errors before that are not recorded.

Operation

1 Press the [PAUSE/MENU] key in the default screen.

▶ MENU screen is displayed.

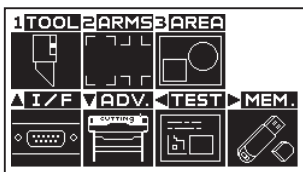

2 Press the POSITION (▼) key (ADV.).

▶ ADVANCE setting screen (1/3) is displayed.

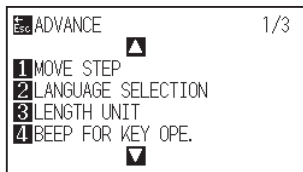

3 Press the POSITION (▲) key.

▶ ADVANCE setting screen (3/3) is displayed.

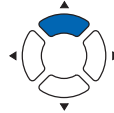
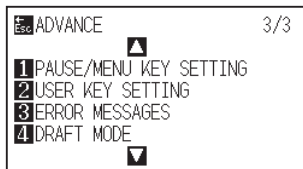

4 Press the [3] key (ERROR MESSAGES).

▶ ERROR MESSAGES list screen is displayed. Left column is time the error occurred, and right column is the type of the error. 4 error messages are displayed at once. If there are more error messages, next 4 messages will be displayed by pressing the POSITION (▲▼) keys.

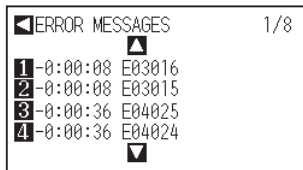

Supplement

- "NO ERROR" will be displayed if there is no error.

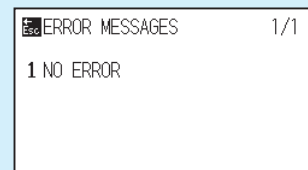

- Up to 4 error messages will be displayed on the screen. Up to 32 error messages can be displayed by pressing the POSITION (▲▼) keys.
- When displayed, while the power is on it indicates how long ago an error occurred. The lower the value, the more recently the error occurred.

5 Press the [1] to [4] keys to see the contents of the error.

▶ Error message corresponding to the pressed key is displayed.

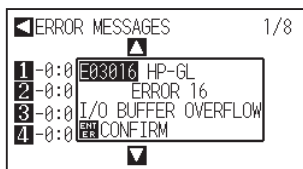

- 6 Press the [ENTER] key (CONFIRM) when the error message is confirmed.
 - ▶ It will return to ERROR MESSAGES list screen.
- 7 Press the [PAUSE/MENU] key.
 - ▶ It will return to default screen.

Supplement

Press the POSITION (▲▼) keys in the screen of step 4 as necessary and repeat steps 5 and 6 if there are multiple error messages you would like to see.

Appendix

This chapter describes the specification of the plotter.

PRODUCT SUMMARY

- A.1 *Main Specifications***
- A.2 *Options and Supplies***
- A.3 *External Dimensions***
- A.4 *Menu Tree***
- A.5 *Initial Setting***

A.1 Main Specifications

	FCX2000-60VC	FCX2000-120VC/ES/MG	FCX2000-180VC
Configuration	Flatbed		
Drive system	Digital servo		
Media hold-down method	VC models: Vacuum suction ES models: Electrostatic adhesion MG models: Magnetic		
Cutting area	610 mm × 920 mm	1200 mm × 920 mm	1800 mm × 920 mm
Mountable media width	950 mm	950 mm	950 mm
Specifiable speeds	400 mm/s (Omnidirection)		
Max. acceleration	5.88 m/s ² (Omnidirection)		
Specifiable speeds	1, 2, 3, 4, 5, 6, 7, 8, 9, 10, 15, 20, 25, 30, 35, 40 cm/s 16 steps		
Max. force	TOOL 1: Max. 4.9N (500gf) TOOL 2: Max. 9.8N (1Kg)		
Settable force	TOOL 1: Set 40 steps TOOL 2: Set 40 steps		
Min. character size	About 10mm ² alphanumeric characters (depending on the materials and font)		
Mechanical resolution	0.0025 mm		
Programmable resolution	GP-GL : 0.1/0.05/0.025/0.01 mm HP-GL*1 : 0.025 mm		
Distance accuracy	Distance moved within ±0.1% or less or within ±0.1 mm or less, whichever is larger (Plotter mode)		
Right angle accuracy	0.5mm/900 mm or less (Plotter mode)		
Repeatable accuracy	0.1 mm or less: Expansion and contraction of the media are excluded (plotter/cutting mode)		
Interface	USB2.0 (full speed) , RS-232C, Ethernet 10BASE-T / 100BASE-TX		
Buffer memory	2 MB		
Resident command sets	GP-GL/HP-GL*1 (Control panel switching, Auto switching)		
Number of cutters/pens	2		
Tool type	VC models: Cutter Plunger, Water based fiber-tip pen, Oil-based ballpoint pen, Creasing tool ES models: Cutter Plunger, Water based fiber-tip pen, Oil-based ballpoint pen, Creasing tool MG models: Cutter Plunger, Water based fiber-tip pen, Oil-based ballpoint pen		
Compatible media	VC models <ul style="list-style-type: none"> • Marking film (PVC/fluorescence/reflection) • Thickness less than 1 mm paper *2 • Thickness less than 0.8 mm compressed foam sheet *4 • Thickness less than 1 mm sandblasting rubber • F, G flute *2 • Clear package sheet • High-intensity reflective film *3 	ES models <ul style="list-style-type: none"> • Marking film (PVC/fluorescence/reflection) • Thickness less than 1 mm paper *2 • Thickness less than 1 mm sandblasting rubber • F, G flute *2 • Clear package sheet *6 	MG models <ul style="list-style-type: none"> • Marking film (PVC/fluorescence/reflection) • Thickness less than 1 mm sandblasting rubber *5
Offline output function	USB memory - 64 files		
Bar code data management function	Yes		
LCD display	Graphic type (240 × 128 dot)		
Usable roll paper	Roll paper hanger Usable roll paper width: 950 mm, weight: 5 kg		
Power supply	100 to 240V AC 50/60Hz		
Power consumption	140 VA or less		
Operating environment	10 to 35°C, 35 to 75 % R.H. (non-condensing)		
Guaranteed accuracy environment	16 to 32°C, 35 to 70 % R.H. (non-condensing)		
External dimensions (W × D × H)	1344 mm × 1409 mm × 930 mm (Media stocker is included.)	1934 mm × 1409 mm × 930 mm (Media stocker is included.)	2534 mm × 1409 mm × 930 mm (Media stocker is included.)
Weigh (Approx.)	76 kg (Including stand)	VC model : 99kg (Including stand) ES model : 95kg (Including stand) MG model : 93kg (Including stand)	116kg (Including stand)

*1 : HP-GL is a registered trademark of the US Hewlett Packard Company.

*2 : Use CB30UC-1 without warpage

*3 : Use cutter blade CB15UA

*4 : Use Cutter blade CB15U-K30

*5 : Magnet and cut material that can be fixed by tape

*6 : Cut material that can be fixed by electrostatic adhesion

A.2 Options and Supplies

Options

Item	Model	Contents	Quantity
Graphtec Pro Studio Plus	-	Software DVD	1 set

Please check our company's home page for the latest information on options.

Supplies

Item	Model	Contents
Cutter plunger	PHP33-CB09N-HS	1 pc: ϕ 0.9 cutter plunger (for CB09UB))
	PHP33-CB15N-HS	1 pc: ϕ 1.5 cutter plunger
	PHP34-CB30-HS	1 pc: CB30UC use only
	PHP35-CB09-HS	1 pc: ϕ 0.9 cutter plunger (for CB09UB)
	PHP35-CB15-HS	1 pc: ϕ 1.5 cutter plunger
Water-based fiber-tip pen plunger	PHP31-FIBER	Water based fiber-tip pen plunger (1 set)
Water-based fiber-tip pen	KF700-BK	1 pair (Black 10 pcs.)
	KF700-RD	1 pair (Red 10 pcs.)
Oil-based ballpoint pen plunger	PHP34-BALL	Oil-based ballpoint pen plunger (1 set)
Oil-based ballpoint pen	KB700-BK	1 pair (Black 10 pcs.)
Blade adjustment magnifier	PM-CT-001	1 pc.
Creasing tool	PM-CT-002	1 pc. (Pen type tip ball ϕ 1.5)
	CP-001	1 pc. (Pen type)
	CP-002	1 pc. (Roller type R0.2): for paperboard
	CP-003	1 pc. (Roller type R0.6): for cardboard
Cling Mat	CM-0004	Film-based mat Adhesive area 435 mm x 610 mm: 2 shts
	CM-0005	Paper-based mat Adhesive area 435 mm x 610 mm: 2 shts.
	CM-0003-R1A	Double-sided adhesive 545 mm x 20 m: 1 roll

For detailed information about the cutter blade, refer to the Cutter Blade Manual.

Please check our company's home page for the latest information on supplies.

A.3 External Dimensions

FCX2000-60VC

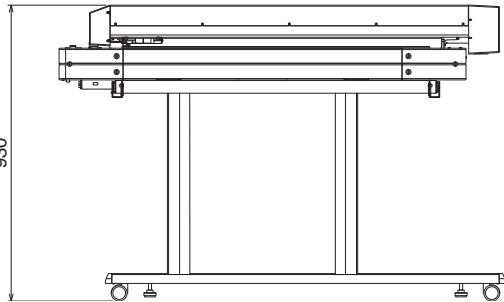
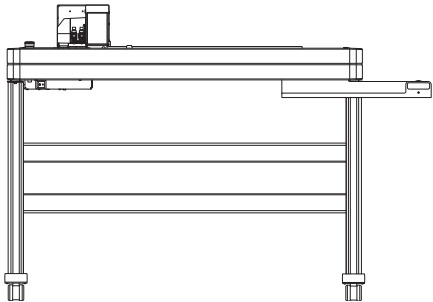
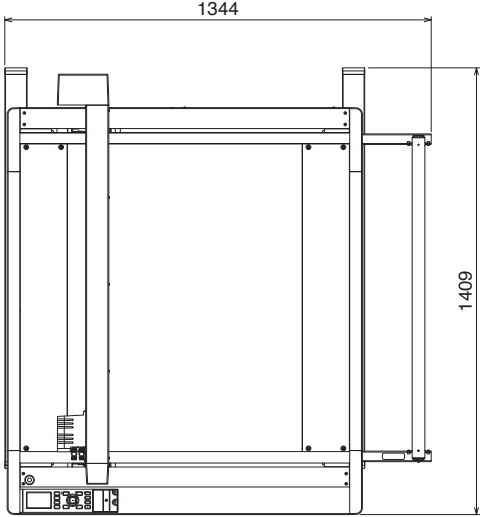

Unit: mm

Dimensional accuracy: ±5mm

FCX2000-120VC/ES/MG

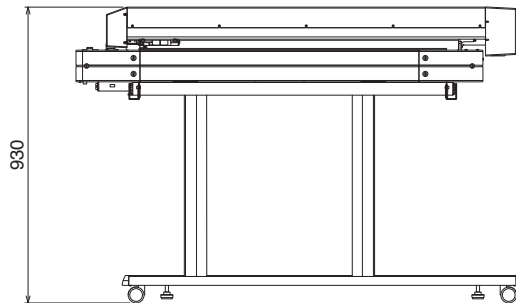
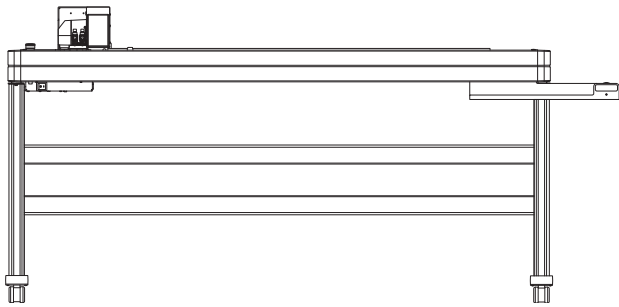
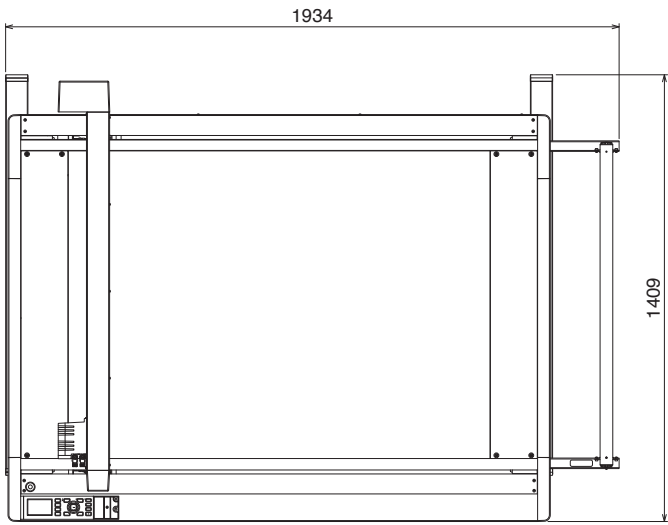

Unit: mm
Dimensional accuracy: ± 5 mm

FCX2000-180VC

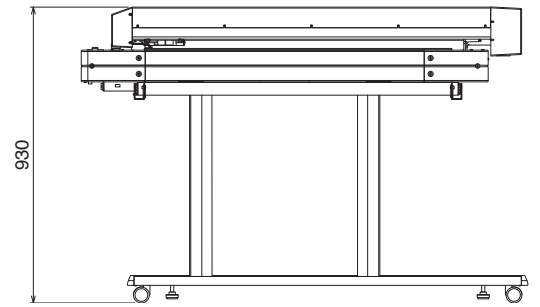
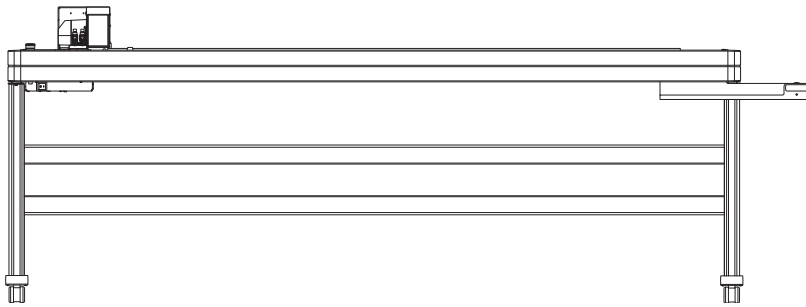
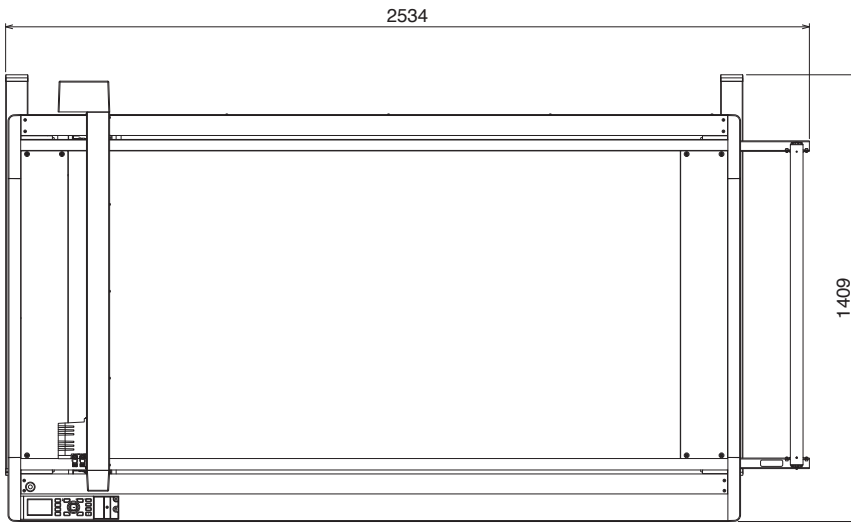

Unit: mm
Dimensional accuracy: $\pm 5\text{mm}$

A.4 Menu Tree

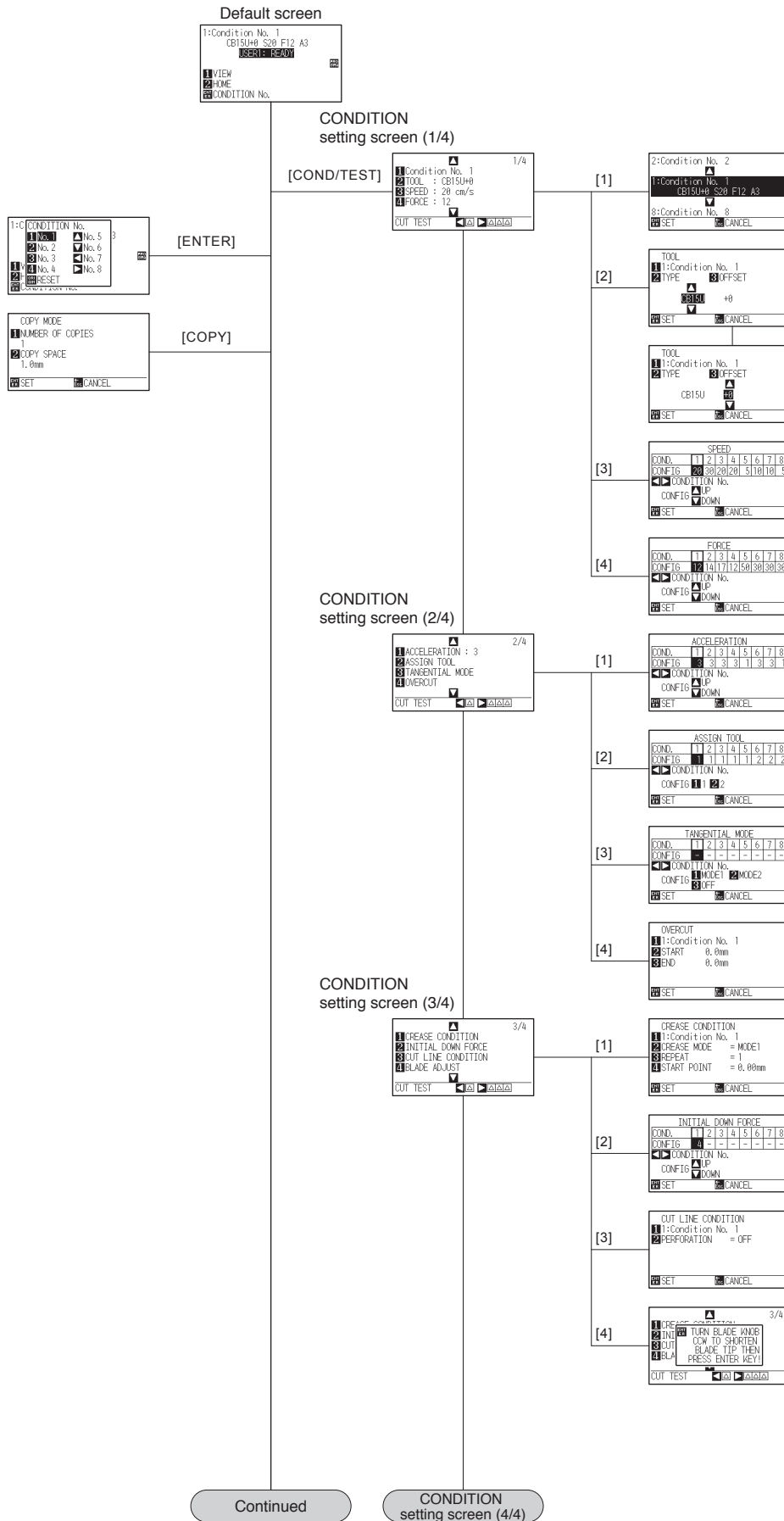

Continued

CONDITION setting screen (4/4)

Default screen
(Continued)

CONDITION
setting screen (3/4)

CONDITION
SETTING screen (4/4)

4/4

- 1 OVERLAY CUT
- 2 NUMBER FOR OVERLAY CUT
- 3 COND. No. FOR 1st CUT

CUT TEST

[1] OVERLAY CUT

ON

SET CANCEL

[2] NUMBER FOR OVERLAY CUT

COND. 1 2 3 4 5 6 7 8

CONFIG - - - - -

CONDITION No.

CONF10 UP

DOWN

SET CANCEL

[3] COND. No. FOR 1st CUT

COND. 1 2 3 4 5 6 7 8

CONFIG - - - - -

CONDITION No.

CONF10 UP

DOWN

SET CANCEL

MENU screen

[PAUSE/MENU]

TOOL PARAMS AREA

SIZE WDVV TEST MEM

TOOLS
SETTING screen (1/4)

[1]

TOOLS SETTING 1/4

- 1 TOOL UP/DOWN
- 2 TOOL OFFSET ADJ.
- 3 STEP PASS
- 4 OFFSET FORCE

[2] TOOL OFFSET ADJ.

TOOL 1-2

TEST PATTERN

X=+0.0mm

Y=+0.0mm

SET CANCEL

[3] STEP PASS

SET CANCEL

[4] OFFSET FORCE

SET CANCEL

TOOLS
SETTING screen (2/4)

[1]

TOOLS SETTING 2/4

- 1 OFFSET ANGLE
- 2 DATA SORTING
- 3 CONDITION PRIORITY
- 4 TOOL SELECT COMMAND SETTING

[1] OFFSET ANGLE

SET CANCEL

[2] DATA SORTING

SORTING OFF

SET CANCEL

[3] CONDITION PRIORITY

MANUAL

PROGRAM

SET CANCEL

[4] TOOL SELECT COMMAND SETTING

ENABLED

DISABLED

SET CANCEL

TOOLS
SETTING screen (3/4)

[1]

TOOLS SETTING 3/4

- 1 TOOL UP MOVE
- 2 TOOL UP SPEED
- 3 TOOL SELECT PAUSE SETTING
- 4 TOOL UP HEIGHT

[1] TOOL UP MOVE

ENABLED

DISABLED

SET CANCEL

[2] TOOL UP SPEED

CONF10

SET CANCEL

[3] TOOL SELECT PAUSE SETTING

ENABLED

DISABLED

SET CANCEL

[4] TOOL UP HEIGHT

NORMAL POSITION

HIGHER POSITION

SET CANCEL

Continued

TOOLS
setting screen (4/4)

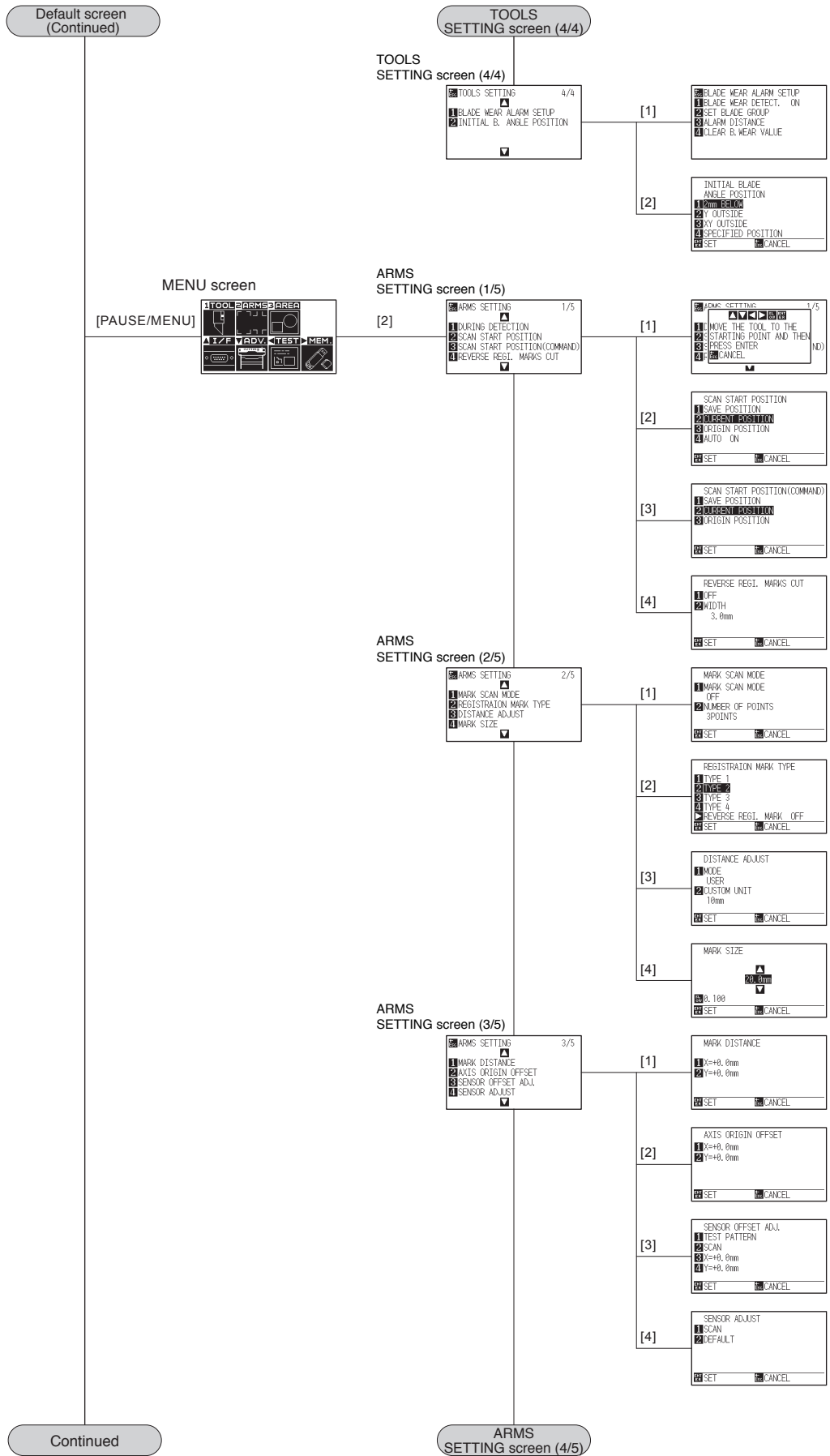

Default screen
(Continued)

ARMS
SETTING screen (3/5)

ARMS
SETTING screen (4/5)

ARMS SETTING 4/5

- 1 MARK AUTO SCAN
- 2 SENSING SPEED
- 3 SENSING METHOD
- 4 SCAN STEP

[1] MARK AUTO SCAN

OFF

SET CANCEL

[2] SENSING SPEED

5000

SET CANCEL

[3] SENSING METHOD

ISM

SET CANCEL

[4] SCAN STEP

DOWN

SET CANCEL

ARMS
SETTING screen (5/5)

ARMS SETTING 5/5

- 1 SENSING LEVEL
- 2 TEST ARMS SENSOR

[1] SENSING LEVEL

TYPE 1, 2

X = 70

Y = 70

DEFAULT

SET CANCEL

[2] ARMS SETTING 5/5

TEST ARMS SENSOR

TYPE 1

TYPE 2

CANCEL

MENU screen

[PAUSE/MENU]

TOOL ARMS AREA

TEST MEM

AREA
SETTING screen (1/2)

AREA PARAMETERS 1/2

- 1 SCALE
- 2 ROTATE
- 3 MIRROR
- 4 DISTANCE ADJUST

[1] SCALE

SET CANCEL

[2] ROTATE

ON

SET CANCEL

[3] MIRROR

ON

SET CANCEL

[4] DISTANCE ADJUST

OFF

X = +0.00%

Y = +0.00%

SET CANCEL

AREA
SETTING screen (2/2)

AREA PARAMETERS 2/2

- 1 AREA
- 2 VIEW POSITION
- 3 CONFIRM CUTTING RANGE

[1] SET UPPER RIGHT

X = +610.000mm

Y = +920.000mm

DEFAULT

SET CANCEL

POSITION KEY

[2] VIEW POSITION

X = +610.000mm

Y = +920.000mm

DEFAULT

SET CANCEL

POSITION KEY

[3] AREA PARAMETERS 2/2

PRESS ENTER KEY AFTER DATA IS TRANSFERRED

DONE

CANCEL

Continued

Default screen
(Continued)

MENU screen



[PAUSE/MENU]

INTERFACE
setting screen (1/3)

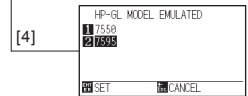
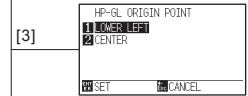
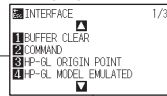

INTERFACE
setting screen (2/3)

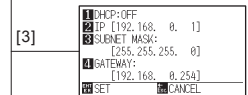
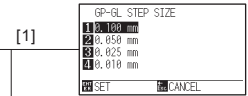

INTERFACE
setting screen (3/3)

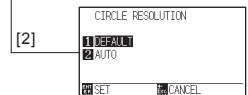
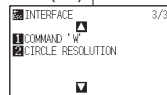

MENU screen



[PAUSE/MENU]

ADVANCE
setting screen (1/3)

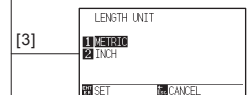
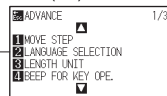

Continued

ADVANCE
setting screen (2/3)

Default screen (Continued)

ADVANCE setting screen (1/3)

MENU screen

ADVANCE setting screen (2/3)

[PAUSE/MENU]



[▲]

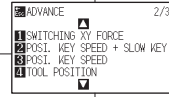

[1]



[2]

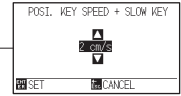

[3]

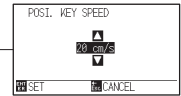

[4]

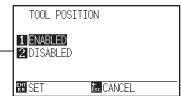

ADVANCE setting screen (3/3)

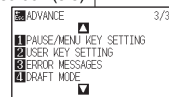

[1]



[2]

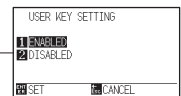

[4]

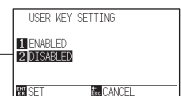

MENU screen

TEST setting screen (1/2)

[PAUSE/MENU]



[◀]



[1]

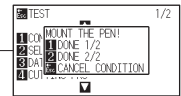

[2]

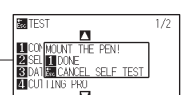

[3]



[4]



TEST setting screen (2/2)

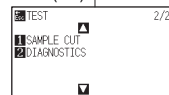

[1]



[2]

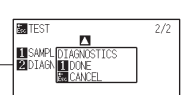

Continued

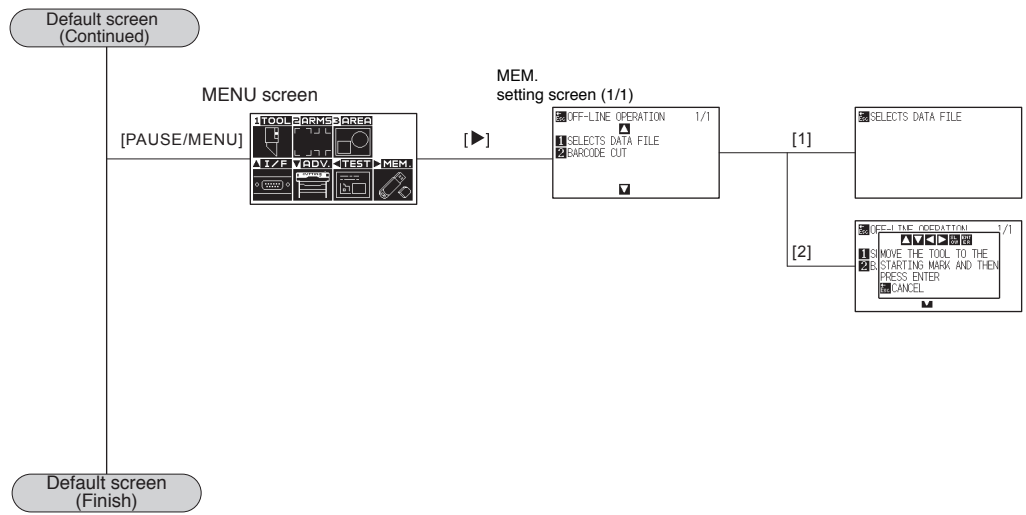

A.5 Initial Setting

Menu items	Setting items	Initial value
TOOLS SETTING	TOOL INTERVAL ADJUSTMENT	0.0mm/0.0mm
	STEP PASS	1
	OFFSET FORCE	4
	OFFSET ANGLE	30
	DATA SORTING	OFF
	TOOL SELECT COMMAND SETTING	ENABLED
	TOOL UP MOVE	DISABLED
	TOOL UP SPEED	30 cm/s
	TOOL SELECT PAUSE SETTING	DISABLED
	CONDITION PRIORITY	PROGRAM
	TOOL UP HEIGHT	NORMAL
	BLADE WEAR ALARM SETUP	OFF
	INITIAL BLADE ANGLE POSITION	2 mm BELOW
ARMS SETTING	SCAN START POSITION	CURRENT POSITION
	SCAN START POSITION (COMMAND)	CURRENT POSITION
	REVERSE REGISTRATION MARK CUTTING	OFF
	REVERSE REGISTRATION MARK WIDTH	3.0mm
	MARK SCAN MODE	OFF
	NUMBER OF POINTS	3 POINTS
	MARK TYPE	TYPE 2
	MODE	USER
	CUSTOM UNIT	10mm
	MARK SIZE	20mm
	MARK DISTANCE (X)	0.0
	MARK DISTANCE (Y)	0.0
	AXIS ORIGIN OFFSET (X)	0.0
	AXIS ORIGIN OFFSET (Y)	0.0
	SENSOR OFFSET ADJ. (X)	0.0
	SENSOR OFFSET ADJ. (Y)	0.0
	MARK AUTO SCAN	ON
	SENSING SPEED	5cm/s
	SENSING METHOD	NORMAL
	SCAN STEP	0μm
	SENSING LEVEL	TYPE 1, TYPE 2
	SENSING LEVEL (X)	TYPE 1, 2: 70 TYPE 3, 4: 85 REVERSE TYPE 1, 2: 70
	SENSING LEVEL (Y)	TYPE 1, 2: 70 TYPE 3, 4: 85 REVERSE TYPE 1, 2: 70
AREA PARAMETER SETTING	SCALE	1
	ROTATE	OFF
	MIRROR	OFF
	DISTANCE ADJUST	OFF, X = +0.00%, Y=+0.00%
	VIEW POSITION	DEFAULT
	AREA (LOWER LEFT)	DEFAULT
	AREA (UPPER RIGHT)	DEFAULT

Menu items	Setting items	Initial value
INTERFACE SETTING	COMMAND	AUTO
	HP-GL ORIGIN POINT	LOWER LEFT
	HP-GL MODEL EMULATED	7595
	GP-GL STEP SIZE	0.100mm
	RS232C (FORWARDING CONDITION NUMBER)	No.1
	RS232C: FORWARDING CONDITION BAUD RATE/BIT LENGTH/PARITY/ HANDSHAKE	RS232C NO.1: 9600/8/NONE/HARD RS232C NO.2: 9600/7/EVEN/HARD RS232C NO.3: 9600/8/EVEN/XONXOFF
	LAN DHCP	OFF
	LAN IP	192.168.0.1
	LAN SUBNET MASK	255.255.255.0
	LAN GATEWAY	192.168.0.254
	“.” “.” COMMAND	ENABLED
	“W” COMMAND	TOOL UP
	CIRCLE COMMAND RESOLUTION	DEFAULT
ADVANCE SETTING	MOVE STEP	0.05 mm
	LANGUAGE SELECTION	Select when initially turning on power
	LENGTH UNIT	Select when initially turning on power
	OPERATION KEY BUZZER	ON
	X & Y FORCE SWITCH	DISABLED
	POSITION KEY LOW MOVEMENT SPEED	2cm/s
	POSITION KEY HIGH MOVEMENT SPEED	20cm/s
	TOOL POSITION DISPLAY	ENABLED
	PAUSE KEY SELECT	PAUSE
	DRAFT MODE	DISABLED
USER KEY	ENABLED	
TEST	NO SETTINGS	—
OFFLINE OUTPUT (MEM.)	NO SETTINGS	—

Menu items	Setting items	Initial value
TOOL SETTING	Condition No.	Condition No. 1
	TOOL	PEN
	SPEED	30
	FORCE	14
	ACCELERATION	3
	OFFLINE NUMBER SET	1
	TANGENTIAL MODE	OFF
	OVERCUT (START / END)	0.0/0.0
	CREASING SET	Condition No. - / Mode 1 / the number of creasing 1/0.00mm
	INITIAL DOWN FORCE	4
CONDITION NO. 1	PERFORATION PATTERN	OFF
	BLADE LENGTH ADJUSTMENT	-
	OVERLAY	OFF
	Condition No.	Condition No. 2
	TOOL	CB15U
	SPEED/FORCE/ACCELERATION/ TOOL NO.	30/16/3/1
	Same as Condition No. 1 from TANGENTIAL MODE to Overlay.	Same as Condition No. 1
	Condition No.	Condition No. 3
	TOOL	CB15U-K30
	SPEED/FORCE/ACCELERATION/ TOOL NO.	30/16/3/1
CONDITION NO. 2	Same as Condition No. 1 from TANGENTIAL MODE to Overlay.	Same as Condition No. 1
	Condition No.	Condition No. 4
	TOOL	CB09U
	SPEED/FORCE/ACCELERATION/ TOOL NO.	30/16/3/1
	Same as Condition No. 1 from TANGENTIAL MODE to Overlay.	Same as Condition No. 1
	Condition No.	Condition No. 5
	TOOL	Other
	SPEED/FORCE/ACCELERATION/ TOOL NO.	30/16/3/1
	Same as Condition No. 1 from TANGENTIAL MODE to Overlay.	Same as Condition No. 1
	Condition No.	Condition No. 6
CONDITION NO. 3	TOOL	CT-002
	SPEED/FORCE/ACCELERATION/ TOOL NO.	30/16/3/2
	Same as Condition No. 1 from TANGENTIAL MODE to Overlay.	Same as Condition No. 1
	Condition No.	Condition No. 7
	TOOL	CP003
	SPEED/FORCE/ACCELERATION/ TOOL NO.	30/16/3/2
	Same as Condition No. 1 from TANGENTIAL MODE to Overlay.	Same as Condition No. 1
	Condition No.	Condition No. 8
	TOOL	Other
	SPEED/FORCE/ACCELERATION/ TOOL NO.	30/16/3/2
CONDITION NO. 4	Same as Condition No. 1 from TANGENTIAL MODE to Overlay.	Same as Condition No. 1

* The initial values of setting items is subject to change.

INDEX

Sign

1, 2, 3, 4	2-8
1 axis adjustment	5-10
2 axes adjustment	5-10
2POINTS	5-8
3POINTS	5-9
4 axes adjustment	5-11
4POINTS	5-9

A

About the Default Screen	2-15
Accessorie	1-2
AC line inlet	1-4
Adjust Automatically	5-45
Adjusting for the Registration Mark Scan Position	5-23
Adjusting the Blade Length	2-3
Adjusting the Sensor Level	5-29
Adjusting the Tool Carriage Height	2-6
Adjust Manually	5-46
Adjustment for Cutting Out	2-29
Adjustment for Half Cutting	2-29
Adjustment of Offset	2-29
Adjust the Blade Length	2-26
Adjust the Blade Length (Automatic Height Adjust)	2-30
Adjust with 2POINTS	5-40
Adjust with 3POINTS	5-42
Adjust with 4POINTS	5-43
ARMS Error Messages	14-8
Attaching a Tool	2-4
Automatic detection of registration mark position	5-6

B

BEEP FOR KEY OPERATION	10-4
BLADE WEAR ALARM	13-7

C

Caution Message	14-14
Change the Cutting Condition	3-6
Changing and Storing RS-232C Settings	9-11
CHART HOLD key	1-4
CIRCLE RESOLUTION	11-9
Cleaning the Cutter Pen	13-5
Clearing the Buffer Memory	9-4
COMMAND	11-2
COMMAND ':', ';', '	11-6
COMMAND 'W'	11-7
CONDITION PRIORITY	11-3
COND/TEST	2-8
Confirming the Cutting Data	14-21
Confirm the Results of the Cutting Test	2-29
Connecting to the Power	2-13
Contents of Operation from [COND/TEST] Key	2-11

Contents of Operation from Menu Screen	2-10
Continuously Move Manually	3-3
Control key	2-7
Control panel	1-4
Control Panel	2-7
Copy	4-7
COPY	2-7
Cutter blade adjustment magnifier	1-2
Cutter Blade Manual	1-2
Cutter blades	1-2
Cutter plunger	1-2
Cutter Plunger Nomenclature	2-2
Cutting area when adjusting the registration mark	5-6
Cutting Direction	3-10
Cutting Test	2-27

D

Daily Maintenance	13-2
Default Screen	2-9
Detect the Registration Mark	5-3
Display Cutting Area	2-33
Display Language Setting	10-2
DRAFT MODE	10-11
Dual Configuration	4-12

E

Emergency Stop Switch	1-4, 1-5
Enabling/Disabling the ':', ';', ' Commands (COMMAND ':', ';', ')	11-6
Enabling/Disabling the Beep Setting	10-4
Enabling/Disabling the Condition Select Command	11-4
ENTER	2-7
Error Messages in GP-GL Command Mode	14-5
Error Messages in HP-GL Command Mode	14-6
ESC	2-7
External Dimensions	A-4

G

GP-GL command	11-5
GP-GL STEP SIZE	11-5

H

Height adjustment plates	1-2
Hexagon driver	1-2
HP-GL command	11-8
HP-GL MODEL EMULATED	11-8

I	
I/F (LAN)	9-5
Indicator Lamp	2-7
Initial Setting	A-14
L	
LANGUAGE SELECTION	10-2
LCD Display	2-16
LENGTH UNIT.	10-3
Loading the Media.	2-12
M	
Manually Adjusting the Sensor Level	5-36
Manual Position Adjust	6-3
Media stocker	1-2, 1-4
Media That Registration Mark Cannot be Sensed	5-7
Menu Tree	A-7
Model ID Response.	11-8
Move Away the Tool Carriage	3-5
Move in Steps Manually	3-3
Moving the Pen While Raised or Lowered in Response to the 'W' Command	11-7
Multiple registration marks	5-11
N	
Network interface connector.	1-4
Network (LAN) interface	9-2
Nomenclature	1-4
O	
Offline Output from USB Memory	12-2
Offset.	2-19
Options	A-3
ORIGIN	2-7
ORIGIN lamp.	2-7
Other Error Messages.	14-11
Outline of ARMS	5-2
Outline of Manual Position Adjust	6-2
Outline of Tangential Mode	7-2
Output with a Bar Code.	12-4
P	
Pause and Resume Cutting	3-12
PAUSE/MENU.	2-7
PAUSE/MENU KEY SETTING	10-9
PAUSE/MENU lamp	2-7
Plotting the CUTTING PRO	14-19
Plotting the Sample Cut Pattern	14-23
Plotting the Test Pattern	14-17
POSI. KEY SPEED	10-7
POSI. KEY SPEED + SLOW KEY.	10-6
POSITION	2-8
Position of the Origin Point	5-5
Power cable.	1-2
Power switch	1-4, 2-13
Printing the Setting of the Plotter	14-15
Priority	11-3
R	
Raise or Lower the Tool	3-2
Reading the Error Message	14-26
Reading the Screen	2-8
Registration mark	5-2
Registration Mark	5-5
Related to Command Processing.	11-2
Related to Menu Display.	10-2
Removing the tool	2-5
Replacing Cutter Blade.	13-3
Replacing the Cutter Plunger	13-6
Reset.	3-6
RS-232C Interface	9-3
RS-232C interface connector	1-4
S	
Safety Precautions	ii
Selecting the tool condition number	2-16
Selecting Tool Condition.	2-16
Self Diagnostic Test	14-25
Sense the Registration Mark for Adjustment on the Media and Enter the Value	5-26
Set IP address, Subnet Mask and Gateway	9-7
Set the enlarge/shrink scale (Scale)	4-5
Setting and Adjustment of ARMS	5-8
Setting Cut Line.	7-14
Setting Cutting Area	4-2
Setting Distance Adjustment Between the Registration Marks	5-15
Setting Mark Distance.	5-18
Setting MARK SCAN MODE and Numbers.	5-8
Setting Mirror.	4-4
Setting Offset Between the Registration Mark and Cutting Origin Point	5-20
Setting of MARK SCAN MODE and Number of Adjustment Marks	6-2
Setting of Step Movement Distance	3-4
Setting Origin Point When HP-GL is Set	3-9
Setting Registration Mark Size	5-17
Setting Scan Step When Registration Marks Are Scanned . 5-34	5-34
Settings for Cutting	4-2
Settings for OFFSET FORCE	7-20
Setting Shape (Pattern) of Registration Mark	5-13
Setting Speed of the Registration Mark Scan.	5-32
Setting the Acceleration	2-25
Setting the Alarm for Degree of Wear.	13-7
Setting the Circle-Command Resolution	11-9
Setting the Command (COMMAND).	11-2
Setting the Creasing Mode	2-20
Setting the Display Length Unit	10-3
Setting the display of the position key	10-8

Setting the Distance Adjust.	7-12
Setting the draft mode.	10-11
Setting the force	10-5
Setting the Force.	2-24
Setting the Initial Blade Angle Position.	7-18
Setting the Initial Down Force.	7-6
Setting the Interface	9-2
Setting the Length of Overcut.	7-4
Setting the Offset Angle	7-10
Setting the Origin Point.	3-7
Setting the Overlay Cut Function	7-21
Setting the pause key	10-9
Setting the position key high speed	10-7
Setting the position key low speed	10-6
Setting the registration mark automatic sensing.	5-31
Setting the Scanning Method	
When Registration Marks are Scanned	5-33
Setting the Speed	2-23
Setting the Step Pass	7-8
Setting the Step Siz.	11-5
Setting the Tangential Mode.	7-3
Setting the Tool	2-19
Setting the Tool Condition.	2-18
Setting the Tool Up Height	8-8
Setting the Tool Up Move	8-4
Setting the Tool Up Speed	8-6
Setting the user key	10-10
SETUP MANUAL	1-2
SLOW	2-8
Sorting the Cutting Data	8-2
Specifications	A-2
Stand.	1-2, 1-4
Stop Cutting	3-12, 3-13
Storing the Plotter	13-2
Structure of Cutter Plunger.	2-2, 13-3
Supplies.	A-3
Switching Setting Numbers.	9-10
SWITCHING XY FORCE.	10-5

T

Test the Registration Mark Sensor	5-38
To cut the corner of thick media sharply.	7-2
TO ENSURE SAFE AND CORRECT USE	i, 1-2
TOLL SELECT COMMAND	11-4
To make 1 cut with set value.	2-27
To make 3 cuts with set value and ± 1 of set value	2-28
Tool	2-19
Tool carriage	1-4
Tool Carriage.	3-3
Tool Condition.	11-3
Tool holder.	2-4
TOOL POSITION	10-8
Troubleshooting.	14-2

U

USB cable	1-2
USB Interface	9-2
USB interface connector.	1-4
USB memory dedicated port.	1-4
USER 1/2.	2-7
USER 1/2 lamp	2-7
USER KEY SETTING	10-10
User's Manual	1-2

V

Vacuum hose connection port	1-4
---------------------------------------	-----

W

Water-based fiber pen.	1-2
Water-based fiber pen adapter	1-2
When Connecting the RS-232C Interface	9-10
When Coordinate Axes Rotation are Set	3-8
When Cutting Data Has No Registration Mark	4-7
When Cutting Data Has Registration Marks.	4-9
When It Does Not Work Right.	14-3
When the Cutting Result is Not Good.	14-4
When the Plotter Does Not Operate	
After Turning the Power On.	14-2
Writing panel	1-4

Y

Y bar	1-4
-----------------	-----

Specifications are subject to change without notice.

FCX2000 User's Manual
FCX2000-UM-151
October 11, 2016 1st edition-01

GRAPTEC CORPORATION

GRAPHTEC