

DM3100

Standalone Model (with monitor)

QuickStart Guide

This document is a simple operating guide for users who want to start measurement right away. It provides explanations on preparations for measurement, measurement basics, and menu operations. For more details, please refer to your User's Manual. In particular, please be sure to read the Usage Precautions.

Checking the Appearance

After unpacking the DM3100, check its outer casing and make sure that there are no surface flaws or stains.

Checking the Accessories

- Main unit (with monitor)
- AC power cord
- AC adapter
- CD-ROM
- Monitor/connection cables

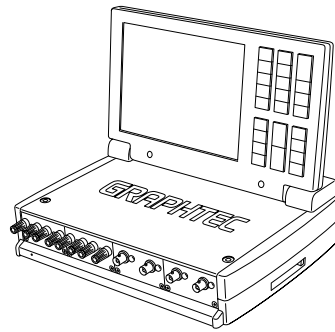

If you discover a defect or find that an accessory is missing, please contact your sales representative or nearest Graphtec vendor.

DM3100-UM-Q52.B1

1. NOMENCLATURE

Front View

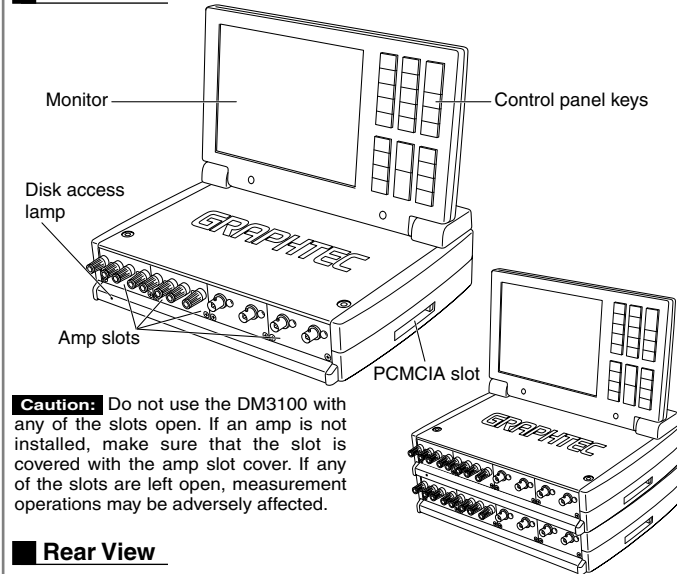

Rear View

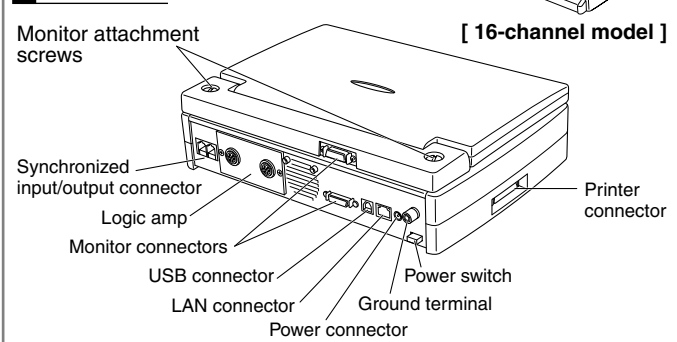

Caution: Do not use the DM3100 with any of the slots open. If an amp is not installed, make sure that the slot is covered with the amp slot cover. If any of the slots are left open, measurement operations may be adversely affected.

2. PREPARATIONS

Connecting the Monitor, Printer, and the Main Unit

- (1) Insert one end of the monitor connection cable into the MONITOR connector on the main unit.
- (2) Insert the other end into the connector on the monitor itself.

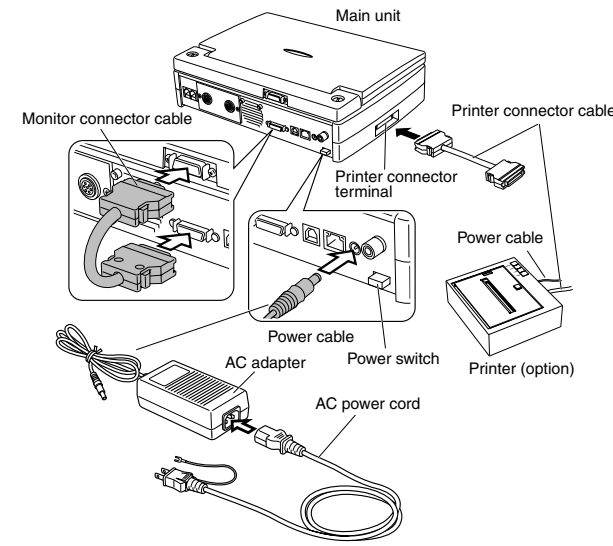

Connecting the AC Adapter

- (1) Check that the Power switch is turned off.
- (2) Insert the AC power cord into the AC adapter.
- (3) Insert the round pin connector into the main unit.
- (4) Insert the power cord's plug into an electrical socket.

Note: We recommend that you connect the GND terminal if there is a lot of noise in the operating environment or if the power supply is unstable.

Attaching the Printer (Option) to the DM3100

- (1) Check that the DM3100 is turned off.
- (2) Connect the printer connector cable provided to the sides of the printer and DM3100.
- (3) Connect the AC adapter power cable to the printer.

Turning the Power On and Off

- (1) Connect the monitor to the main unit, and check that the AC adapter is connected.
- (2) Open the monitor to the position at which you plan to use it, and then turn on the power switch.
- (3) The initial RECORDER screen is displayed on the LCD.
- (4) Press the START/STOP key to scroll through the screen and to start measurement.
- (5) To stop the scrolling and measurement operations, press the START/STOP key once again.

Note: The explanation above is for when you use the DM3100 for the very first time. After you have changed any of the measurement conditions, the settings that were in effect when you last turned the DM3100 off are recalled when you switch it on again.

- (6) Turn the power switch off by pressing it once again to release it from the locked On status.

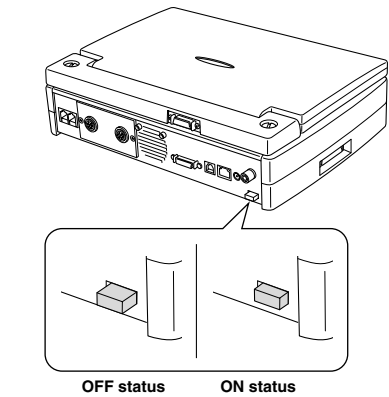

Key used in this operation

INPUT	SHIFT	START STOP
MEMORY	LOCAL	
RECORD	COPY	TRIGGER
READOUT	CURSOR	REPLAY EXIT
SYSTEM	CH SEL.	MODE
EXECUTE	▲	□
ENTER	▼	○
◀	▶	▶▶
◀◀	▶▶▶	

Main Unit Input Terminal Numbers

The channels are numbered from right to left, with channel 1 at the right.

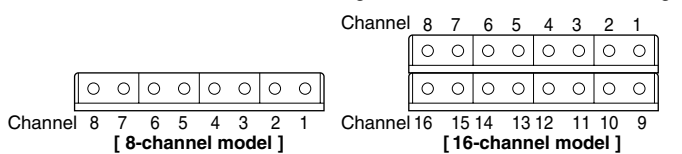

3. SETTING OPERATIONS

Basic Screen Operations

- (1) Select the item you want to make settings for.
- (2) Use the Direction (Up, Down, Left, Right) keys to move within the screen.
- (3) Press the ENTER key to register your setting.
- (4) Press the EXECUTE key to execute the currently selected operation.
- (5) Press the CANCEL key if you want to change the setting you just made.
- (6) Press the CLOSE key to close the currently opened window.

Tip: Use the Window Help and Cursor Help functions to check your setting operations.

AMP Settings

CH	AMP	Input	Range	Filter	Misc.
1	V	DC	500mV	Off	▼
2	V	DC	1V	Line	▼
3	V	GND	2V	500Hz	▼
4					▼
5					▼
6	V	GND	2V	500Hz	▼
7	V	CAL	5V	10Hz	▼
8	V				▼

Logic: Disable Threshold: 100

Window Help

Performs amp-related settings

Cursor Help

Saves the screen data as bitmap data

Main keys used in this operation

INPUT	SHIFT	START STOP
MEMORY	LOCAL	
RECORD	COPY	TRIGGER
READOUT	CURSOR	REPLAY EXIT
SYSTEM	CH SEL.	MODE
EXECUTE	▲	□
ENTER	▼	○
◀	▶	▶▶
◀◀	▶▶▶	

Screen Menu Settings

The menu screens and the contents of the pages displayed vary according to which Settings key is pressed, as shown below.

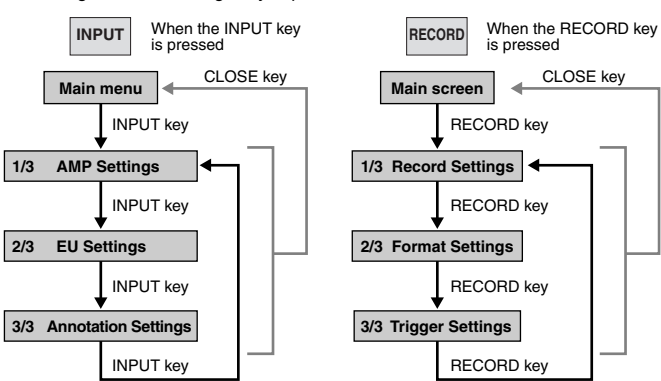

Contents of the Menu Settings Pages

Key name/ Page No.	1	2	3	4
INPUT	AMP Settings	EU Settings	Annotation Settings	-
MEMORY	Memory Settings	Data Replay Settings	-	-
RECORD	Record Settings*	Format Settings	Trigger Settings	-
READOUT	Readout Menu	-	-	-
SYSTEM	System Settings	Option Settings	Customize Settings	System Information
CURSOR	Cursor Settings	-	-	-
MODE	RECORDER	FFT	-	-

*The Scroll, Fixed, Oscillo and X-Y modes are selectable from a menu in the Waveform Display mode.

4. BASIC OPERATIONS

Setting the Date and Time

- (1) Turn on the power.
- (2) Press the SYSTEM key twice to display the System 2/4 Options Settings page.
- (3) Use the Direction keys to align the cursor with the Date/Time setting. The time is for a 24-hour clock.
- (4) Press the ENTER key to enter the mode for changing the date and time. Use the left/right Direction keys to move the cursor to the position where you want to make the change. Press the ENTER key to enable the change to be made.
- (5) Use the up/down Direction keys to change the value. Press the ENTER key to register each new value.
- (6) When all the changes have been made, press the EXECUTE key to register the new date and time.
- (7) Press the CLOSE key to close the Settings window.

Keys used in this operation

READOUT	CURSOR	REPLAY EXIT
SYSTEM	CH SEL.	MODE
EXECUTE	▲	□
ENTER	▼	○
◀	▶	▶▶
◀◀	▶▶▶	

Option Settings

- (1) Turn on the power.
- (2) Press the SYSTEM key twice to display the System 2/4 Options Settings page.
- (3) Use the up/down Direction keys to align the cursor with the item for which you wish to make changes.
- (4) When all the changes have been made, press the EXECUTE key to register the settings.
- (5) Press the CLOSE key to close the Settings window.

Option Settings System(2/4)

[Option Settings]	Off
Screen saver:	On
Help View:	Default
Background Color:	Disable
Power On Start:	Off
Printer:	Off
Beeper Function:	On
Key Click:	On
Date/Time:	2002-01-06 00:20:50
New Line Code:	CR+LF
ID:	0
[TCP-IP Settings]	Change Settings
IP Address:	192.168.1.11
Subnet Mask:	255.255.255.0
Port Number:	1111

Window Help

Sets the option functions

Cursor Help

Saves the screen data as bitmap data

Direction (Up, Down, Left, Right) keys:

Align the cursor with the black triangle, and then press the ENTER key to open a pull-down window directly underneath for making changes to the displayed setting.

Align the cursor with the white triangle, and then press the ENTER key to open a new settings window for this item.

5. MAIN SPECIFICATIONS

Main Unit Specifications

DM3100	
Analog Input	8-channel model: 4 slots (8 channels) 16-channel model: 8 slots (16 channels)
Logic Input	8-channel model: 1 slot (8 channels) 16-channel model: 2 slots (16 channels)
PC Interface	Ethernet (10 base-T/100 base-TX) USB (Ver. 1.1)
Memory capacity	512 keywords/ch
Internal memory	40 GB HDD (Option, must be specified with initial order) PCMCIA slot (Type 2)
Isolation voltage	1 min. at 1500 VAC (between the AC power supply and frame)
Isolation resistance	20 M ohms or more at 500 VDC (between the AC power supply and frame)
Backup functions	Settings: EEPROM, Clock: Secondary lithium battery
Operating conditions	0 to 40 °C, 30 to 80% RH, non-condensing (5 to 35 °C for printing and when using the HDD)
Operating noise level	Standby status: Within 60 dBA
Power rating	AC adapter (100 to 240 VAC)
Power consumption	8-ch model: approx. 90 VA; 16-ch model: approx. 135 VA
External dimensions	8-ch model: 300 (W) × 222 (D) × 78 (H) mm 16-ch model: (W) × 222 (D) × 135 (H) mm (excluding rubber feet and protruberances for both models)
Weight	8-ch model: approx. 3.2 kg (including 4 amp units; excluding the AC adapter) 16-ch model: (approx. 5.0 kg (including 8 amp units; excluding the AC adapter)

Amp Specifications (all channels are floating ground input)

Amp Type	Item	Specification
Voltage amp (DM3-V AMP)	Range	500 mV to 200 V
	Max. sampling speed	1 μs
	Input terminal type	BNC connector
Voltage/Temperature amp (DM3-M AMP)	Range	Voltage: 20 mV to 500 V Temperature: K, J, T, R, E, B
	Max. sampling speed	10 μs
	Input terminal type	Banana-plug connector
DC Strain amp (DM3-DCB AMP)	Range	100 to 2000 × 10 ⁹ /Div strain
	Frequency band	DC to 20 kHz
	Input terminal type	7-pin round connector
Frequency amp (DM3-FV AMP)	Range	200 Hz to 40 kHz
	Max. sampling speed	4 μs
	Input terminal type	BNC connector
Logic amp (B-503)	Input voltage range	0 to 25 V max. (single-ended ground input)
	Max. sampling interval	1 μs
	Input terminal configuration	Dedicated 4-channel terminals

6. USEFUL FUNCTIONS

- (1) Selecting the Waveform Display Mode

Record: Waveform display mode

- (a) Scroll: Scrolls the screen in accordance with the waveform display
 (b) Fixed: The display is fixed to one screen, but is updated.
 (c) Oscillo: A waveform is displayed with each trigger
 (d) XY: A maximum of 8 XY channels is displayed
 (e) FFT*: Waveform analysis display

*Press the MODE key to toggle between the RECORDER and FFT modes.

- (2) Switching From One Display Screen to Another

- (a) When the mode is Scroll or Oscillo

To switch between the standard and wide screens, press the SHIFT + MODE keys.

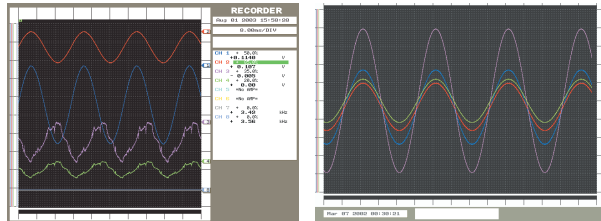

Standard screen

Wide screen

- (b) When the mode is XY waveform display

To switch between the wide and narrow screens, select Record → XY Settings → Size

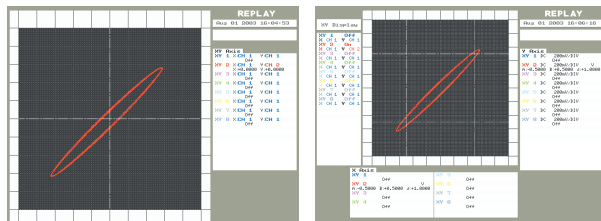

Wide screen

Narrow screen

- (3) Cursor Display Function

Apart from using the Cursor key, the cursor can be moved in REPLAY mode after waveform output by pressing the EXECUTE key. The cursor switches through Single, Dual, and Off with each press of the EXECUTE key. After a Dual Cursor display, press the ENTER key to switch through the other cursor options.

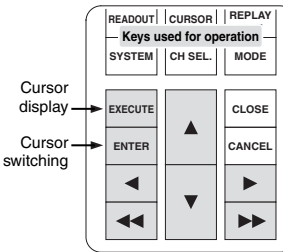

- (4) Functions That Can Be Changed During Operation

Use the following keys to change the time axis, range, and position settings.

- ▲, ▼: Move the setting position
- ◀, ▶: Change the time axis, range and position values
- ◀◀, ▶▶: Switch between the range and position settings

	Time axis	Range	Position
Scroll mode	No	Yes	Yes
Fixed mode	No	Yes	Yes
Oscillo mode	Yes*	Yes	Yes
XY mode	No	No	No

* However, if the sampling interval is fast, stop measurement before making the change.

- (5) Scale/Channel Annotation Display

During measurement, the scale values and annotation can be displayed. Use the ▲ and ▼ keys to switch between the displays.

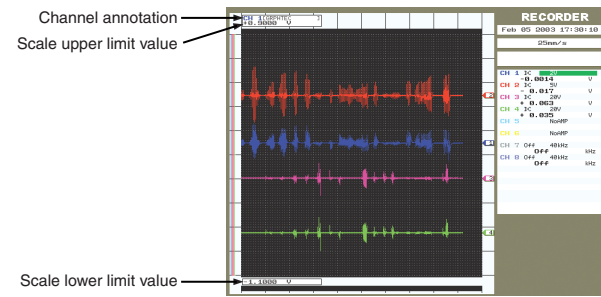

8. VOLTAGE/TEMPERATURE AMP SETTINGS

Voltage/Temperature (M) Amp: DM33-M AMP

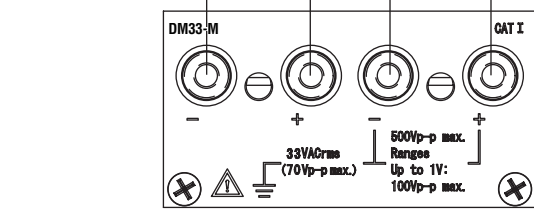
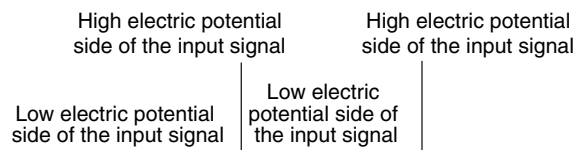

Maximum permissible input voltage

Between + and - input terminals	2 V to 500 V ranges : 500 VDC (DC + AC _{p-p}) 20 mV to 1 V ranges: 100 VDC (DC + AC _{p-p})
Between an input terminal and ground	33 VAC r.m.s.

Please use Graphtec-supplied or other banana-plug cables.

<Reference>

Voltage input

RIC-115: bare tips (2 m); sold in sets of 2, 4, 8, or 16 cables

Temperature input

Thermocouples (contact your Graphtec vendor for details)

Checking Measurement Signals Using the Memory Functions (Voltage/Temperature amp)

• **Mode:** RECORDER (Oscillo mode)

• **Measurement conditions settings (example):**

Range: K (0 to 100°C), Filter: Line, Trigger: Off, Memory Chain: Off

Note: Fullscale display only for temperature measurement

Key operation	Procedure	Measurement	Memory Settings			REPLAY		CURSOR	Data Replay
			Sampling	Block Size	Chain	Function	Start		
1 SYSTEM	Customize	Full Scale							
2 INPUT	Input	TEMP							
3	Range Setting	TC-K							
4	Span Upper/Lower Values	+100/0							
5	Filter Setting	Line							
6 MEMORY	Sampling Interval	1ms							
7	Block Size	4KW							
8	Memory Chain				Off				
9 RECORD	Trigger Function						Memory		
10	Trigger Start							Off	
11	Trigger Stop								Off
12 Control	Start Measurement	START							
13 Panel Keys	Stop Measurement	STOP							
14 MEMORY	Block Destination								Block 1
15 Control	Data Replay								On
16 Panel Keys	Cursor Confirmation								On
17	Waveform Confirmation								Single
18	Return to Measurement								SHIFT+REPLAY

Note: Please change the Sampling Interval and Block Size settings to suit measurement fluctuations and the required measurement time.

* Press EXECUTE to display the cursor

Checking Measurement Signals in Realtime (Voltage/Temperature amp)

• **Mode:** RECORDER (Scroll mode)

• **Measurement conditions settings (example):**

Range: K (0 to 100°C), Filter: Line, Trigger: Off, Memory: Off

Key operation	Procedure	Measurement	Amp Settings			RECORD	CURSOR	Data Replay
			Input	Range	Span			
1 SYSTEM	Customize	Full Scale						
2 INPUT	Input	TEMP						
3	Range Setting	TC-K						
4	Upper Level Value	+100						
5	Lower Level Value	0						
6	Filter Setting	Line						
7 RECORD	Chart Speed							1mm/s
8 Control	Start Measurement	START						
9 Panel Keys	Stop Measurement	STOP						

Note: Please change the Amp and Chart Speed settings to suit measurement fluctuations and the required measurement time.

7. VOLTAGE AMP SETTINGS

Voltage (V) Amp: DM3-V AMP

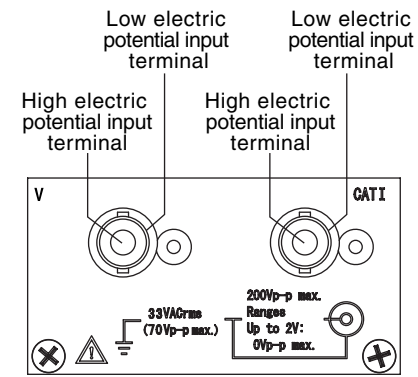

Maximum permissible input voltage

Between + and - input terminals	5 V to 200 V ranges : 200 VDC (DC + AC _{p-p}) 50 mV to 2 V ranges: 30 VDC (DC + AC _{p-p})
Between an input terminal and ground	33 VAC r.m.s.

Please use Graphtec-supplied or other BNC cables.

<Reference>

RIC-112: BNC — BNC cable (1.5 m)

RIC-113: BNC — Banana plug cable (1.5 m)

RIC-114: BNC — Alligator-clip cable (1.5 m)

9. DC STRAIN AMP SETTINGS

DC Strain (DCB) Amp: DM3-DCB AMP

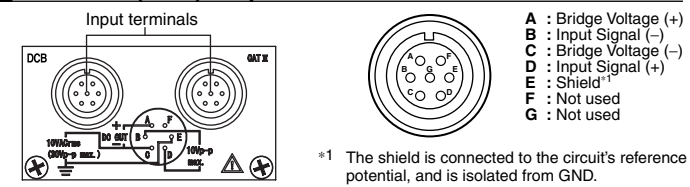

*1 The shield is connected to the circuit's reference potential, and is isolated from GND.

Checking Measurement Signals in Realtime (DC Strain amp)

• **Mode:** RECORDER

• **Measurement conditions settings (example):**

Range: 10mε, Filter: 50 Hz, Trigger: Off, Memory: Off

Key operation	Procedure	Measurement	Amp Settings			RECORD	CURSOR	Data Replay
			Input	Range	Span			
1 INPUT	Input	DC						
2	Range Setting	10mε						
3	Span Upper/Lower Values	+5.000/-5.000						
4	Filter Setting	50Hz						
5	Chart Speed	20mm/s						20mm/s
6 RECORD	Start Measurement	START						
7 Control	Stop Measurement	STOP						

Note: Please change the Amp and Chart Speed settings to suit measurement fluctuations and the required measurement time. For details on inputs, please refer to your User's Manual.

Checking Measurement Signals Using the Memory Functions (DC Strain amp)

• **Mode:** RECORDER

• **Measurement conditions settings (example):**

Range: 10mε, Filter: 50 Hz, Trigger: Off, Memory Chain: Sequential

Key operation	Procedure	Measurement	Memory Settings			Trigger Settings		REPLAY	CURSOR	Data Replay
			Sampling	Block Size	Chain	Function	Start			
1 INPUT	Input	DC								
2	Range Setting	10mε								
3	Span Upper/Lower Values	+5.000/-5.000								
4	Filter Setting	50Hz								
5	Chart Speed	20mm/s								
6 MEMORY	Sampling Interval	1ms								
7	Block Size	4KW								
8	Memory Chain				Sequential					
9 RECORD	Trigger Function							Memory		
10	Trigger Start								Off	
11	Trigger Stop									Off
12 Control	Start Measurement	START								
13 Panel Keys	Stop Measurement	STOP								
14 MEMORY	Block Destination									Block 1
15 Control	Data Replay									On
16 Panel Keys	Cursor Confirmation									On
17	Waveform Confirmation									Single
18	Return to Measurement									SHIFT+REPLAY

Note: Please change the Sampling Interval and Block Size settings to suit measurement fluctuations and the required measurement time.

Checking Measurement Signals in Realtime (Voltage amp)

• **Mode:** RECORDER

• **Measurement conditions settings (example):**

Range: 1V, Filter: Off, Trigger: Off, Memory: Off

Key operation	Procedure	Measurement	Amp Settings			RECORD	CURSOR	Data Replay
			Input	Range	Span			
1 INPUT	Input	DC						
2	Range Setting	1V						
3	Span Upper/Lower Values	+0.5000/-0.5000						
4	Filter Setting	Off						
5 RECORD	Chart Speed	20mm/s						20mm/s
6 Control	Start Measurement	START						
7 Panel Keys	Stop Measurement	STOP						

Note: Please change the Amp and Chart Speed settings to suit measurement fluctuations and the required measurement time.

Checking Measurement Signals Using the Memory Functions (Voltage amp)

• **Mode:** RECORDER

• **Measurement conditions settings (example):**

Range: 1V, Filter: Off, Trigger: Off, Memory Chain: Sequential

Key operation	Procedure	Measurement	Memory Settings			Trigger Settings		REPLAY	CURSOR	Data Replay
			Sampling	Block Size	Chain	Function	Start			
1 INPUT	Input	DC								
2	Range Setting	1V								
3	Span Upper/Lower Values	+0.5000/-0.5000								
4	Filter Setting	Off								
5 RECORD	Chart Speed	20mm/s								
6 MEMORY	Sampling Interval	1ms								
7	Block Size	4KW								
8	Memory Chain				Sequential					
9 RECORD	Trigger Function							Memory		
10	Trigger Start								Off	
11	Trigger Stop									Off
12 Control	Start Measurement	START								
13 Panel Keys	Stop Measurement	STOP								
14 MEMORY	Block Destination									Block 1
15 Control	Data Replay									On
16 Panel Keys	Cursor Confirmation									On
17	Waveform Confirmation									Single
18	Return to Measurement									SHIFT+REPLAY

Note: Please change the Sampling Interval and Block Size settings to suit measurement fluctuations and the required measurement time.

Frequency-to-Voltage (FV) Amp: DM3-FV AMP

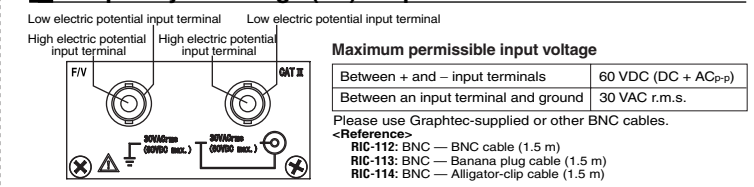

*1 The shield is connected to the circuit's reference potential, and is isolated from GND.

Checking Measurement Signals in Realtime (Voltage/Temperature amp)

• **Mode:** RECORDER

• **Measurement conditions settings (example):**

Range: 0 to 40 kHz, Filter: Off, Trigger: Off, Memory: Off

Key operation	Procedure	Measurement	Amp Settings			RECORD	CURSOR	Data Replay
			Input	Range	Span			
1 INPUT	Input	DC						
2	Range Setting	40kHz						
3	Span Upper/Lower Values	+40kHz/0						
4	Filter Setting	Off						
5 RECORD	Chart Speed	20mm/s						20mm/s
6 Control	Start Measurement	START						
7 Panel Keys								